

# PROSPECTUS

dated 05/12/2024

for the

## Public Offering

of

**1,400,000 AWEARE Global Tokens**

**ISIN: LI1363014385**

of



**AWEARE Global AG**

PRINCIPALITY OF LIECHTENSTEIN

## **NOTES FOR INVESTORS / SALES RESTRICTIONS**

This document constitutes a prospectus (the “Prospectus”) in accordance with Regulation (EU) 2017/1129 of the European Parliament and of the Council of 14 June 2017 (“Prospectus Regulation”).

The Prospectus has been prepared as a single document pursuant to Art 6 (3) of the Prospectus Regulation. Pursuant to Art 24 (1) of the Commission Delegated Regulation (EU) 2019/980 of 14 March 2019 (“DelReg 2019/980”), it consists of the table of contents, the summary, the risk factors and the information to be provided in this Prospectus as set out in Annexes 1 and 11 of DelReg 2019/980, whereby the order of the information set out in the Annexes has been permissibly freely chosen.

This Prospectus has been approved by the Financial Market Authority Liechtenstein (the “FMA”), as competent authority under the Prospectus Regulation. AWEARE Global AG (the “Issuer”) has requested FMA to notify the competent authority in Austria, Germany, Ireland, Italy, Luxemburg, Malta and Spain in relation to this Prospectus with a certificate of approval attesting that this Prospectus has been drawn up in accordance with the Prospectus Regulation and providing it with an electronic copy of this Prospectus (“Notification”).

This Prospectus will be registered in Switzerland with the reviewing body SIX Exchange Regulation AG, BX Swiss AG or another reviewing body approved by the Swiss Financial Market Supervisory Authority (“FINMA”), as a foreign prospectus that is also deemed to be approved in Switzerland pursuant to Art 54 (2) of the Swiss Financial Services Act (“FinSA”) together with the Swiss Financial Services Ordinance (“FinSO”) for inclusion on the list of approved prospectus pursuant to Art 64 (5) FinSA, deposited with this review and published pursuant to Art 64 FinSA.

The securities have not been approved or disapproved by the U.S. Securities and Exchange Commission, any state securities commission or any other regulatory authority in the United States, nor have any of the foregoing authorities passed upon or endorsed the merits of the offering of the securities or the accuracy or the adequacy of the Prospectus. Any representation to the contrary is a criminal offence in the United States. The securities have not been and will not be registered under the United States Securities Act of 1933, as amended (“Securities Act”), or with any securities regulatory authority of any state or other jurisdiction of the United States and (i) may not be offered, sold or delivered within the United States to, or for the account or benefit of U.S. Persons (as defined in Regulation S under the Securities Act), and (ii) may be offered, sold or otherwise delivered at any time only to transferees that are Non-United States Persons (as defined by the U.S. Commodities Futures Trading Commission).

### Declaration of Domicile

Due to United States of America laws and regulations, this offering is not available for those with jurisdiction and/or domicile in the United States, Iran, Russia, North Korea, Belarus, Syria, and any territories thereof. If any prospective investor with jurisdiction and/or domicile in these nations or territories make an incorrect or false answer regarding jurisdiction and/or domicile outside of these nations or territories, that prospective investor understands that making incorrect/false statements may be considered felony offences including but not limited to perjury, wire fraud, and making false statements, depending on their specific local laws and circumstances.

Tokenholders must declare that they are a bona fide resident of the country of the Domiciled Country as per KYC and reside in and maintain at least one place of abode in the Domiciled Country which they recognize and intend to maintain as their permanent home. If maintaining one or more other places of abode outside of the Domiciled Country, Tokenholders must also declare that the Domiciled Country constitutes their predominant and principal home.

Tokenholders must affirm and attest to the fact that they are not domiciled in the United States of America, Russia, Iran, North Korea, Belarus, Syria, or any territories thereof.

Tokenholders must declare that they will inform the Issuer's administration through electronic means: [admin@awaretech.li](mailto:admin@awaretech.li) if at any time they intend to change their Domiciled Country to the United States, Russia, Iran, North Korea, Belarus, Syria, or any territories thereof for the express purpose of reviewing held securities as subject to repurchase.

Tokenholders must further certify that they understand there is a penalty for perjury; and that perjury is a felony and is punishable by fines and/or incarceration in accordance with national and/or state laws.

The corresponding paragraph above applies to Australia, Japan and Canada, as well as territories thereof. Separately, the securities may not be offered, sold, or otherwise delivered to Russia, Iran, North Korea, Belarus, Syria, and territories thereof.

The Prospectus does not constitute an offer or an invitation or a solicitation to subscribe to the securities to any person subject to a jurisdiction in which such an offer or invitation or solicitation is prohibited or in which persons making such an offer or invitation or solicitation are not entitled to do so, nor is it intended for any person to whom it would be illegal to make such an offer or invitation or solicitation. Information derived from sources other than the Prospectus and documents available in the public domain should be treated as unauthorised and unreliable. Potential investors should ensure that they are properly informed of the possible tax consequences, the relevant legislation and any potential currency restrictions or foreign exchange controls applicable in their native country or their country of permanent or temporary residence which might be of relevance to the act of subscribing to, holding, converting, redeeming or alienating the securities. Further tax considerations are discussed in the Prospectus.

Every investment in securities is associated with risks and its value is subject to operational and market-related fluctuations. General investment risks may include currency, transfer, country, liquidity, creditworthiness, interest rate, price and credit risks as well as political, legal, market, technology, competition, and tax risks. This also applies to the securities offered on the basis of this Prospectus (including any supplements).

The securities being offered are participation certificates of the Issuer which are issued in the form of tokens. Participation certificates are securities which represent a certain participation in the Issuer. Tokens are book-entry securities which are issued and transferred to a decentralised database (blockchain).

The return on investments in the AWEARE Global Tokens is composed of potential dividend payments and price gains/losses of the AWEARE Global Tokens and cannot be predicted with certainty. The dividend is the profit of the Issuer distributed by resolution of the General Meeting of the Issuer.

Investors are required to read the full Prospectus (including any supplements). The information contained in this Prospectus (including any Supplements), in particular the information in the section "Risk Factors", should be considered by any potential investor prior to subscription or purchase of the AWEARE Global Tokens.

There are various risks associated with the subscription and holding of the AWEARE Global Tokens. In accordance with the legal requirements of Regulation (EU) 2017/1129, risk factors are only addressed in this Prospectus (including any supplements) to the extent that they are risks which, in the opinion of the Issuer, are specific, material and confirmed for the Issuer and the securities. Indeed, it is prohibited

to include risk factors in prospectuses which serve exclusively to exclude liability. Thus, the Issuer does not guarantee that the risks described in the section “Risk Factors” are comprehensive and complete and that no further or different risks may arise. It is expressly pointed out that in individual cases further individual risks may occur. Furthermore, risks may occur not only individually but also cumulatively.

It is not sufficient to read and understand the risk factors. Potential investors should be aware of the risks associated with an investment in the Tokens and should not make an investment decision until they have obtained comprehensive advice from their legal, tax, technology, market, and financial advisor, auditor, or any other expert regarding the suitability of an investment in the Tokens, taking into account their personal financial and tax situation and other personal circumstances and the information contained in this Prospectus (including any supplements).

The occurrence of one or more of the risks listed in the section “Risk Factors” may have a material adverse effect on the assets and liabilities, financial position and/or results of operations and the business of the Issuer in general, which in turn may have a direct effect on the value of and income from the Token. It is recommended that investors have a sound knowledge and experience of how blockchain, smart contracts and crypto currencies work before purchasing the Token.

Investors must decide for themselves whether an investment in the AWEARE Global Token is appropriate for them. In particular, each investor should:

- have sufficient knowledge and experience to fully evaluate the Token and the benefits and risks of investing in the Token and the information contained in this Prospectus (including supplements);
- have sufficient financial resources and liquidity to bear all risks associated with the investment;
- fully understand the terms and conditions of this Prospectus (including any supplements) and be aware of trends and developments in relevant financial market indicators;
- be able, alone or with the assistance of an advisor, to evaluate possible scenarios of economic trends, technology, market, interest rates, and other factors that may affect the investment in the Token and the investor’s ability to bear potential risks.

Investors bear the risk that an investment in the AWEARE Global Token may not be appropriate for them.

**Investors could lose all or part of the capital invested (TOTAL LOSS RISK).**



## TABLE OF CONTENTS

TABLE OF CONTENTS	5
I. SUMMARY OF THE PROSPECTUS	8
II. ZUSAMMENFASSUNG DES PROSPEKTS	13
III. NOTA DI SINTESI DEL PROSPETTO	19
IV. NOTA DI SINTESI DEL FOLLETO	24
V. SAMMANFATTNING AV PROSPEKT	30
VI. RESUMÉ AF PROSPEKTET	35
VII. PE3YOME HA ΠPOCΠEKTΑ	41
VIII. SHRNUŤÍ PROSPEKTU	47
IX. SAMENVATTING VAN HET PROSPECTUS	52
X. PROSPEKTI KOKKUVÖTE	58
XI. ESITTEEN TIIVISTELMÄ	63
XII. RÉSUMÉ DU PROSPECTUS	69
XIII. ΠEPIΛHΨH TOY ENHMEPΩTIKOY ΔEΛTIOY	74
I. A TÁJÉKOZTATÓ ÖSSZEFOGLALÓJA	80
XIV. PROSPEKTA KOPSAVILKUMS	86
XV. PROSPEKTO SANTRAUKA	91
XVI. SAMMENDRAG AV PROSPEKTET	97
XVII. PODSUMOWANIE PROSPEKTU EMISYJNEGO	102
XVIII. RESUMO DO PROSPECTO	108
XIX. REZUMATUL PROSPECTULUI	113
XX. ZHRNUTIE PROSPEKTU	119
XXI. POVZETEK PROSPEKTA	124
XXII. SAMANTEKT Á LÝSINGARLÝSINGU	130
XXIII. SAŽETAK PROSPEKTA	135
XXIV. PROSPEKTÜSÜN ÖZETİ	140
XXV. SUMMARY VUM PROSPEKT	145
XXVI. MAIN BODY OF THE PROSPECTUS	152
1. Persons responsible, third party information and competent authority approval	152
1.1 Persons responsible	152
1.2 Deviating Representation	152
1.3 Statement	152
1.4 Information Sourced from Third Parties	153
2. Strategy, Performance and Business Environment	154
2.1 Information about the Issuer	154
2.2 Business overview	155
2.2.1 Strategy & objectives - Navigating the Evolution of Autonomous Driving: Challenges, Setbacks, and the Promise of AWEARE Radar	156
2.2.2 Principal Activities	163
2.2.3 Business Strategy	164
2.2.4 Principal and Potential Markets	165
2.2.5 Exceptional Influences	167
2.2.6 Competitive Position	168
2.3 Investments	170

2.4 Trend information	170
2.5 Profit forecasts or estimates	172
3. Risk Factors	173
3.1 Risks faced by the Issuer	174
3.2 Risks faced by the Issuer' Business	176
3.3 Risks which are specific to the securities	181
4. Terms and Conditions of the Securities	182
4.1 Information concerning the securities to be offered	182
4.1.1 Description of the type and class of the securities	182
4.1.2 Legislation under which the securities have been created	183
4.1.3 Currency of the securities issue	183
4.1.4 Description of the rights attaching to the securities including restrictions	183
4.1.5 Resolutions by virtue of which the securities have been or will be created and/or issued	183
4.1.6 Expected issue date of the securities	183
4.1.7 Restrictions on the free transferability of the securities	184
4.1.8 Warning	184
5. Details of the Offer/Admission to Trading	184
5.1 Terms and conditions of the offer of securities to the public	184
5.1.1 Conditions to which the offer is subject	184
5.1.2 Issue volume	187
5.1.3 Offer period and application process	187
5.1.4 Reduction of subscriptions	187
5.1.5 Minimum and/or maximum amount of application	187
5.1.6 Right of withdrawal	187
5.1.7 Delivery and settlement	188
5.1.8 Results	188
5.2 Plan of distribution and allotment	188
5.2.1 Categories of investors	188
5.3 Process for notifying applicants of the amount allotted and an indication whether dealing may begin before notification is made	188
5.4 Pricing	189
5.5 Paying agent	189
5.6 Admission to trading and dealing arrangements	189
5.7 Total net proceeds and estimated issue costs	189
5.8 Applicable Law	189
5.9 Place of Jurisdiction	190
5.10 Severability	190
6. Corporate Governance	190
6.1 Board of Directors	190
6.2 Administrative, Management and Supervisory bodies' and Senior Management's conflicts of interests	192
6.3 The Auditor	193
6.4 Remuneration and benefits	193
6.5 Board Practices	193
6.6 Employees	193

6.7 Shareholdings and stock options	194
7. Financial Information	194
7.1 Historical financial information	194
7.2 Significant change in the issuer's financial position	195
7.3 Dividend policy	195
8. Shareholder and security holder information	195
8.1 Major ordinary shareholders	195
8.2 Legal and arbitration proceeding	196
8.3 Share capital	196
8.4 Information on the borrowing requirements and funding structure	196
8.5 Information regarding any restrictions on the use of capital resources that have materially affected, or could materially affect, directly or indirectly, the issuer's operations	196
9. Essential Information	196
9.1 Working capital statement	196
9.2 Capitalisation and indebtedness	196
9.3 Interest of natural and legal persons involved in the issue	197
10. Taxation	197
10.1 Taxation of the Issuer	197
10.2 Taxation of Participants	197
10.2.1 Participants resident in Liechtenstein	197
10.2.2 Participants resident abroad	197
10.3 Responsibility for withholding taxes at source	197
11. Documents Available	197
12. Material Contracts	198
13. Signature Page	199

# I. SUMMARY OF THE PROSPECTUS

This summary contains all the elements required to be included in a summary for this type of securities and issuer.

SECTION 1 – INTRODUCTION		
1.1	<b>Name and ISIN of the securities</b>	The <b>1,400,000</b> new participation certificates publicly are non-voting bearer participation certificates of AWEARE Global AG. The name of these participation certificates is " <b>AWEARE Global Tokens</b> ". The ISIN is LI1363014385.
1.2	<b>Identity and contact details of the issuer, including its legal entity identifier (LEI)</b>	<b>AWEARE Global AG</b> (the „Issuer“) c/o Revalier Aktiengesellschaft Pradafant 11, 9490 Vaduz, Principality of Tel: +423 237 63 47 Email: <a href="mailto:info@awaretech.li">info@awaretech.li</a> The LEI is: 391200PTNEZNXGJW1C39
1.3	<b>Competent Authority</b>	<b>Financial Market Authority</b> (the „FMA“) Landstrasse 109, 9490 Vaduz, Principality of Liechtenstein Tel: +423 236 73 73 Fax: +423 236 73 74 Email: <a href="mailto:info@fma-li.li">info@fma-li.li</a>
1.4	<b>Date of approval of the prospectus</b>	05/12/2024
1.5	<b>Warnings</b>	
1.5.1		<ul style="list-style-type: none"> <li>a) The summary should be read as an introduction to this Prospectus. Any decision to invest in the securities should be based on consideration of the Prospectus as a whole by the investor.</li> <li>b) The investor could lose all or part of the invested capital.</li> <li>c) Where a claim relating to information contained in the prospectus is brought before a court, the plaintiff investor might, under national law, have to bear the costs of translating the Prospectus before the legal proceedings are initiated.</li> <li>d) Civil liability attaches only to those persons who have tabled the summary including any translation thereof, but only if the summary is misleading, inaccurate or inconsistent, when read together with the other parts of the Prospectus or it does not provide, when read together with the other parts of the Prospectus, key information in order to aid investors when considering whether to invest in the securities.</li> </ul>
SECTION 2 – KEY INFORMATION ON THE ISSUER		
2.1	<b>Who is the issuer of the securities?</b>	
2.1.1	<b>Information about the issuer</b>	<ul style="list-style-type: none"> <li>a) The legal and commercial name of the Issuer is “AWEARE Global AG”. The Issuer is a public limited company incorporated in the Principality of Liechtenstein and governed by the laws of the Principality of Liechtenstein. The Issuer has its registered office in Vaduz, Principality of Liechtenstein and is registered at the Office of Justice / Commercial Register of the Principality of Liechtenstein under registration number FL-0002.714.015-4.</li> <li>b) The purpose of the Issuer is to develop and monetise sensor technologies and artificial intelligence for autonomous vehicles and other applications.</li> <li>c) The Issuer’s main shareholders are: <ul style="list-style-type: none"> <li>• Global Innovation Partners Limited, British Virgin Islands with majority shareholders Dr. Daniel Hyman, Mahesh Reddy, Dr. Reginald Tang, and Mark Hyman</li> </ul> </li> <li>d) The Issuer’s Board of Directors consists of: <ul style="list-style-type: none"> <li>• Dr. Daniel Hyman, Nationality: United States, Mailing Address: Long Beach, California, USA</li> <li>• Mahesh Reddy, Nationality: United States, Mailing Address: Irvine, California, USA</li> <li>• Marcel Füssinger, Nationality: Austria, Mailing Address: 160009, Singapore</li> <li>• Revalier AG represented by Reinhold Wohlwend, Nationality: Liechtenstein, Mailing Address: 9490, Vaduz, Liechtenstein</li> </ul> </li> <li>e) The Auditor is: Lucas Tihanyi, Member of the Liechtenstein Association of Auditors and EXPERTsuisse, Industriering 14, 9491 Ruggell, Liechtenstein</li> </ul>
2.2	<b>What is the key financial information regarding the issuer?</b>	
2.2.1		The Issuer was founded on 30/11/2023 by entry in the commercial register of the Principality of Liechtenstein. According to the declaration of the Board of Directors dated 25 October 2023, the Issuer is not subject to an

ordinary audit and is not subject to an audit review. However, the annual financial statements as at 31 December 2023 and the interim financial statements as at 15 July 2023 were audited by the Auditor.

The following key financial information has been prepared in accordance with the provisions of the Liechtenstein Persons and Companies Law ('PCL'), in particular Art. 1024 et seq.

#### Income statement

	31/12/2023	15/07/2024
<b>Total revenue</b>	USD 0	USD 0
<b>Operating profit/loss</b>	USD -2'473.03	USD -30'150.54
<b>Net profit/loss</b>	USD -2'473.03	USD -30'150.54

#### Balance sheet

	31/12/2023	15/07/2024
<b>Total assets</b>	USD 50'184.35	USD 75'244.30
<b>Total equity</b>	USD 47,526.97	USD 19'849.46
<b>Net financial debt (long term debt plus short term debt minus cash)</b>	USD 0	USD 0

#### Cash flow statement

	31/12/2023	15/07/2024
<b>Relevant net Cash flows from operating activities</b>	USD 0	USD 0
<b>Relevant net Cash flows from investing activities</b>	USD 0	USD 0
<b>Relevant net Cash flows from financing activities</b>	USD 0	USD 0

The Issuer's outlook has not deteriorated significantly since the interim balance sheet date as at 15/07/2024. There have been no significant changes in the Issuer's financial position or trading position since the reporting date of the interim balance sheet as at 15/07/2024.

### 2.3 What are the key risks that are specific to the issuer?

#### 2.3.1 Low capital

The Issuer's purpose is the commercialisation of AWEARE's technology. The Issuer's equity capital is limited to USD 50,000.00, where the minimum capital required under Liechtenstein law is USD 50,000.00. As the Issuer was incorporated on 30/11/2023, no significant historical financial data or key figures, other than the historical financial information referred to in section 2.2.1 of this summary, are available to assess the financial situation of the Issuer in relation to the past years. The Issuer is not subject to an ordinary audit and does not have an audit review. The Issuer has not been evaluated by a rating agency. Low equity capital represents an increased risk for the investor, as the function as liable capital is correspondingly reduced.

#### 2.3.1 Insolvency risk

In the event of the opening of insolvency proceedings over the assets of the Issuer, the Issuer will be temporarily or permanently limited in disposals of its assets, or dispositions of assets of the Issuer will be taken over by a court appointed insolvency administrator. This may have a negative impact on the financial position and the business activities of the Issuer. This case can occur even if insolvency applications were filed incorrectly. In the event of insolvency of the Issuer, the Participants are liable with their invested capital. The invested capital is to be treated as equity and is therefore qualifiedly subordinated.

	<p><b>Business financing</b> There is no minimum capital to be raised. There is no placement guarantee, but rather the risk that the AWEARE Global Tokens will not be fully subscribed (placement risk). If the Issuer does not succeed in soliciting the desired issue volume, the Issuer will be able to invest less. There is a risk of a capital shortfall for the Issuer. In addition, the emission costs, which are independent of the amount of capital raised, will remain, which will increase the expense ratio in relation to the total investment capital raised. There is a risk that in this case the Issuer will not achieve its intended investment objectives and will not be able to meet its obligations under the AWEARE Global Tokens.</p> <p><b>Management, technology, third party service provider reliance, competition and development timeframes</b> One of the Issuer's key strengths is its astute use of the latest radar technology. However technical advantages in the information and communications technology industry may be short lived. Accordingly, the issue's success will depend, in part, on its ability to manage and expand the Issuer's services and grow its business' user base and therefore generate revenue in response to changing technologies, user and third-party service providers' demands and competitive pressures. Failure or delays in doing so may adversely impact the success of the Issuer.</p> <p><b>Human error with smart contracts</b> The Issuer assumes no liability and makes no representations or warranties as to the functionality of the Issuers project or of any smart contracts that may be programmed or used for the settlement of the offering in accordance with this Prospectus in the broadest sense. Investors may suffer impairments as a result or generally face a total loss. However, in such scenarios, legal mechanisms may apply to protect an investor from loss.</p>	
<b>SECTION 3 – KEY INFORMATION ON THE SECURITIES</b>		
3.1	<b>What are the main features of the securities?</b>	
3.1.1	<b>Information about the securities</b>	
a)	<b>Description of the type and class of the securities</b>	The <b>1,400,000</b> new participation certificates publicly offered by the Issuer are non-voting bearer participation certificates, each with a nominal value of <b>USD0.01</b> of the participation capital (the " <b>AWEARE Global Tokens</b> ")., from a new issue of participation capital resolved by an extraordinary General Meeting on 18/07/2024. Holders of AWEARE Global Tokens are called " <b>Participants</b> " or " <b>Tokenholders</b> ".
b)	<b>Currency of the securities issue</b>	United States Dollar (" <b>USD</b> " or " <b>\$</b> "). The term of the AWEARE Global Token is unlimited.
c)	<b>Description of the rights attaching to the securities</b>	<p><b>Right to vote</b> AWEARE Global Tokens are non-voting participation certificates and do not entitle the Participant to vote at, to convene the, and to participate in the General Meeting of the Issuer. Furthermore, AWEARE Global Tokens do not grant the right to information, the right of inspection, and the right to make an application. However, a written request for information or inspection or for the initiation of an official audit may be submitted to the General Meeting.</p> <p><b>Announcement of convening and resolutions of the General Meeting</b> Participants must be notified of the convening of the General Meeting together with the items on the agenda and the motions. Every resolution of the General Meeting must be made available for inspection by the Participants at the registered office of the Issuer without delay. The Participants shall be informed of this in the notice.</p> <p><b>Dividend entitlement and share of liquidation proceeds</b> AWEARE Global Tokens carry full dividend rights from the date of valid acquisition and entitle their holders to a share of the liquidation proceeds in proportion to their participation in the participation capital. The Issuer does not currently plan to distribute dividends in the near future. Although a claim to dividends exists under the Articles of Association, no forecasts are made regarding future dividend distributions. The Issuer intends to reinvest profits in the further growth and development of the company.</p> <p><b>Form and securitisation</b> AWEARE Global Tokens will be issued as tokens. Tokens are value rights that are issued on a decentralised database (Blockchain) and transferred there. The Blockchain used for this purpose is the Ethereum Blockchain.</p> <p><b>Exclusion of subscription rights and participation rights</b> Until the target participation capital of USD 50,000 is reached, the preferential rights according to Articles 304d, 304f and 304g PCL, in particular subscription rights and participation rights of the Participants, are excluded.</p> <p><b>Transferability of the securities</b> The transfer (such as transfer in the narrow sense, pledging, inheritance) of AWEARE Global Tokens requires the approval of the Issuer's Board of Directors.</p>

		Transferability is therefore limited to a certain extent. In any case, a transfer of AWEARE Global Tokens is not permitted if they would then be held by a person in a country in which AWEARE Global Tokens may not be offered. A transfer in the above sense is also deemed to occur if a Tokenholder moves its place of residence to a country in which AWEARE Global Tokens may not be offered.
d)	<b>Relative seniority of the securities in the issuer's capital structure in the event of insolvency</b>	In the event of insolvency of the Issuer, Participants are liable with their invested capital. The invested capital is to be treated as equity and is therefore qualifiedly subordinated.
e)	<b>Description of dividend policy</b>	No dividends have been paid to date. The Issuer does not make any profit forecasts or estimates and therefore a description of the dividend policy is not made. Dividends, if any, will be paid in USD. The Issuer reserves the right to pay dividends also in another currency or cryptocurrency. Any resolution to pay dividends will be taken in accordance with applicable law and will depend, inter alia, on the Issuer's results of operations, financial position, contractual restrictions and capital requirements. In any case, 5% of the net profit will be allocated to the statutory reserves until this has reached the amount of 10% of the paid-in share capital.
<b>3.2</b>	<b>Where will the securities be traded?</b>	
<b>3.2.1</b>	AWEARE Global Tokens are not admitted to trading on a regulated market. The Issuer reserves the right to apply for admission to trading on a regulated market.	
<b>3.4</b>	<b>What are the key risks that are specific to the securities?</b>	
<b>3.4.1</b>	<p><b>Investors Wallet and Private Key Risk</b> The investor alone bears the risk of the selection of the wallet or the location of the private key. If an incompatible wallet is used or if the private key is lost, access to the AWEARE Global Tokens is normally impossible. The consequences, such as the total loss of the investment, must be borne solely by the investor.</p> <p><b>Risk of saleability, liquidity and realisation risk</b> There is no certainty that a liquid market will develop for the AWEARE Global Tokens. As a result, AWEARE Global Tokens could not be sold on a secondary market, creating liquidity risk for the investor.</p> <p><b>Volatility risk</b> There are risks in connection with the volatility of the share price. If AWEARE Global Tokens were to be sold and they were caught in a sharp downward price fluctuation, the Tokenholder could suffer losses, some of which could be substantial, as a result of the sale.</p> <p><b>Loss of Tokens</b> Tokens may be lost or become inaccessible, in particular if the Tokenholder loses the respective private key to dispose of its AWEARE Global Tokens or due to malfunctioning of the e-wallet in which the AWEARE Global Tokens are stored. This could result in the loss of Tokens. It is the Tokenholders' sole responsibility to safely store and protect the private key that allows access to the e-wallet. Tokens may become inaccessible also in the case of death of a Tokenholder if he or she did not make arrangements for such cases. Neither the Issuer nor any other body or institution will be capable of restoring the access to the Tokenholder's wallet for the successors of the Tokenholder. The loss of private keys could furthermore reduce the availability of various functionalities of the STO and the AWEARE Global Tokens. In particular, it may be impossible to issue AWEARE Global Tokens to subscribers or to make them transferable in which case they would remain paused indefinitely. Furthermore it may be impossible to make dividend payments. Finally, there is a risk that an attacker may mint AWEARE Global Tokens for non-contributing addresses, alter confirmation status, contribute uncontrolled amounts to the STO or allow the attacker to withdraw unclaimed dividend payments.</p> <p><b>Limited rights of Tokenholder</b> AWEARE Global Tokens are non-voting participation certificates and do not entitle the Tokenholders to vote at, to convene the, and to participate in the General Meeting of the Issuer. Furthermore, AWEARE Global Tokens do not grant the right to information, the right of inspection, and the right to make an application. The Issuer's General Meeting may therefore adopt resolutions which may adversely affect Tokenholder rights. Tokenholders have no possibility to control the use of proceeds from the issuance of AWEARE Global Tokens. The transfer (such as transfer in the narrow sense, pledging, inheritance) of AWEARE Global Tokens requires the approval of the Issuer's Board of Directors. In any case, a transfer of AWEARE Global Tokens is not permitted if they would then be held by a person in a country in which AWEARE Global Tokens may not be offered. A transfer in the above sense is also deemed to occur if a Tokenholder moves its place of residence to a country in which AWEARE Global Tokens may not be offered. The statutory subscription right of the Tokenholders in the event of a capital increase under this offer is excluded.</p> <p><b>Tokenholders' claims are subordinated</b> The rights of Tokenholders to claim and receive dividend payments from the Issuer is junior to the claims of all</p>	

	holders of unsubordinated obligations of the Issuer. In a liquidation of the Issuer, Tokenholders will be paid only if and after all senior obligations of the Issuer have been discharged.
<b>SECTION 4 – KEY INFORMATION ON THE OFFER OF SECURITIES TO THE PUBLIC</b>	
<b>4.1</b>	<b>Under which conditions and timetable can I invest in this security?</b>
	<p><b>Countries in which the securities are offered</b> The offering consists of public offers in the Austria, Belgium, Bulgaria, Croatia, Cyprus, Czech Republic, Denmark, Estonia, Finland, France, Germany, Greece, Hungary, Iceland, Ireland, Italy, Latvia, Liechtenstein, Lithuania, Luxembourg, Malta, Netherlands, Norway, Poland, Portugal, Romania, Slovakia, Slovenia, Spain, Sweden, Switzerland as well as private placements in certain jurisdictions outside thereof.</p> <p><b>Countries in which the securities are not offered</b> AWEARE Global Tokens of the Issuer are not and will not be registered under the provisions of the United States Securities Act of 1933, as amended, or with the securities regulatory authorities of any state of the United States of America, or in Australia, Japan or Canada. Accordingly, they will not be offered, sold or delivered directly or indirectly to the public, except pursuant to an exemption from the registration requirements. In particular, this Prospectus does not constitute or constitute an offer to sell or the solicitation of an offer to purchase AWEARE Global Tokens in the United States of America, Australia, Japan and Canada and may not be distributed therein. In addition, this Prospectus does not constitute or constitute an offer to sell or the solicitation of an offer to purchase AWEARE Global Tokens in Russia, Iran, or North Korea, Belarus, Syria, or any territories thereof. And may not be distributed therein.</p> <p><b>Bidding</b> The subscription process for AWEARE Global Tokens will take place online at <a href="https://kyc.awearetech.li/">https://kyc.awearetech.li/</a> (the “Dashboard”).</p> <p><b>Offer Period</b> The period during which investors may submit their purchase offers for AWEARE Global Tokens is to begin on the date of approval of the Prospectus and to end one year later (the “Offer Period”). On the last day of the Offer Period, offers may be made until 12:00 noon Liechtenstein time.</p> <p><b>Bid Price</b> The bid price of one AWEARE Token is <b>USD12.00</b> (the “Bid Price”).</p> <p>To encourage early investment, the following discounts are available:</p> <p>For investments between 10,000 USDC and 49,999.99 USDC, investors will receive a discount of 10%, making the price per AWEARE Token USD10.80.</p> <p>For investments of 50,000 USDC or more, investors will receive a discount of 15%, making the price per AWEARE Token USD10.20.</p> <p><b>Availability of discounts</b> The above discounts are available <b>until one of the following occurs, whichever comes first:</b></p> <ul style="list-style-type: none"> <li>● <b>reaching a total investment volume of 5,000,000 USDC, or</b></li> <li>● <b>expiration of three months from the start of the offer.</b></li> </ul> <p><b>Delivery and settlement</b> Each investor must complete the online subscription process at the Dashboard. AWEARE Global Tokens will be allocated off-chain as a record in the Issuer’s database, which can be visible through the Dashboard, against payment of the Bid Price. AWEARE Global Tokens will be allocated on-chain in the Smart Contract at the latest within two months after the end of the Offer Period. Once the total offering of AWEARE Global Tokens (after reaching the target participation capital) has ended and the Issuer has decided to finalise the Smart Contract, AWEARE Global Tokens will be delivered to the investor’s crypto wallet.</p> <p><b>Dilution</b> Since the statutory subscription right of all Participants is excluded in the event of a capital increase in the context of this offer, the Participants of this offer will not be diluted.</p> <p><b>Total net proceeds and estimated issue costs</b> The total net proceeds of the offer over 1,400,000 AWEARE Global Tokens may amount to approximately <b>USD15,000,000</b> corresponding to the implementation of the fund raise. The expected total costs of the offer amount to approximately <b>USD1,500,000</b> and will be charged from the proceeds.</p>
<b>4.2</b>	<b>Why is this prospectus being produced?</b>
<b>4.2.1</b>	a) The estimated net proceeds from the issue of the securities will be used primarily for research and development and IP protection. It might be necessary to shift up to 50% of an allocated budget to another



	<p>position if required.</p> <ul style="list-style-type: none"> <li>i) 10% Cost of Raise</li> <li>ii) 11% General &amp; Administrative</li> <li>iii) 41% Research &amp; Development</li> <li>iv) 17% Legal (Global IP Protection)</li> <li>v) 21% Bus Dev, Sales &amp; Marketing</li> </ul> <p>b) The current shareholders of AWEARE Technologies Inc. and Global Innovation Partners Limited include Mahesh Reddy and Dr. Daniel Hyman. Mahesh Reddy and Dr. Daniel Hyman are also directors and minority shareholders of the Issuer.</p> <p>c) Equanimity AG receives a transaction fee of 3% of the total crypto currencies and fiat payments accrued. Marcel Füssinger, who is one of the Directors of the Issuer, is also the Director and owner of Equanimity AG.</p> <p>d) <b>Total net proceeds and estimated issue costs</b> The total net proceeds of the offer over 1,400,000 AWEARE Global Tokens may amount to approximately <b>USD15,000,000</b> corresponding to the implementation of the fund raise. The expected total costs of the offer amount to approximately <b>USD1,500,000</b> and will be charged from the proceeds.</p> <p>e) <b>Underwriting Arrangements</b> The offering is not subject to a firm underwriting agreement. There is no agreement under which an underwriter is obliged to underwrite unsold tokens. Therefore, there is no guarantee that the entire offering will be placed.</p>
--	--

## II. ZUSAMMENFASSUNG DES PROSPEKTS

Diese Zusammenfassung enthält alle Angaben, die in einer Zusammenfassung für diese Art von Wertpapieren und diesen Emittenten erforderlich sind.

ABSCHNITT 1 - EINFÜHRUNG		
1.1	<b>Name und ISIN der Wertpapiere</b>	Bei den <b>1.400.000</b> neuen Partizipationsscheinen handelt es sich um stimmrechtslose Inhabertizipationsscheine der AWEARE Global AG. Die Bezeichnung dieser Genussscheine lautet " <b>AWEARE Global Tokens</b> ". Die ISIN lautet LI1363014385.
1.2	<b>Identität und Kontaktdaten des Emittenten, einschließlich seiner Rechtspersonenkennung (LEI)</b>	<b>AWEARE Global AG</b> (die " <b>Emittentin</b> ") c/o Revalier Aktiengesellschaft Pradafant 11, 9490 Vaduz, Fürstentum Vaduz Telefon: +423 237 63 47 E-Mail: <a href="mailto:info@awearetech.li">info@awearetech.li</a> Der LEI lautet: 391200PTNEZNXGJW1C39
1.3	<b>Zuständige Behörde</b>	<b>Finanzmarktaufsichtsbehörde</b> (die " <b>FMA</b> ") Landstrasse 109, 9490 Vaduz, Fürstentum Liechtenstein Telefon: +423 236 73 73 Fax: +423 236 73 74 E-Mail: <a href="mailto:info@fma-li.li">info@fma-li.li</a>
1.4	<b>Datum der Billigung des Prospekts</b>	05/12/2024
1.5	<b>Warnungen</b>	
1.5.1	<ul style="list-style-type: none"> <li>a) Die Zusammenfassung sollte als Einführung in diesen Prospekt gelesen werden. Jede Entscheidung, in die Wertpapiere zu investieren, sollte auf der Grundlage der Prüfung des gesamten Prospekts durch den Anleger erfolgen.</li> <li>b) Der Anleger könnte sein gesamtes oder einen Teil seines investierten Kapitals verlieren.</li> <li>c) Wird eine Klage in Bezug auf im Prospekt enthaltene Informationen bei Gericht eingereicht, muss der klagende Anleger nach nationalem Recht möglicherweise die Kosten für die Übersetzung des Prospekts vor Einleitung des Gerichtsverfahrens tragen.</li> <li>d) Zivilrechtlich haftet nur derjenige, der die Zusammenfassung einschließlich einer Übersetzung davon vorgelegt hat, allerdings nur, wenn die Zusammenfassung irreführend, unrichtig oder widersprüchlich ist, wenn sie zusammen mit den anderen Teilen des Prospekts gelesen wird, oder wenn sie, wenn sie zusammen</li> </ul>	

mit den anderen Teilen des Prospekts gelesen wird, keine Schlüsselinformationen enthält, die den Anlegern bei der Entscheidung über eine Anlage in die Wertpapiere helfen sollen.

## ABSCHNITT 2 - BASISINFORMATIONEN ÜBER DEN EMITTENTEN

### 2.1 Wer ist der Emittent der Wertpapiere?

#### 2.1.1 Informationen über den Emittenten

- a) Die rechtliche und kommerzielle Bezeichnung der Emittentin lautet "AWEARE Global AG". Die Emittentin ist eine im Fürstentum Liechtenstein gegründete Aktiengesellschaft, die dem Recht des Fürstentums Liechtenstein unterliegt. Die Emittentin hat ihren Sitz in Vaduz, Fürstentum Liechtenstein, und ist beim Amt für Justiz/Handelsregister des Fürstentums Liechtenstein unter der Registernummer FL-0002.714.015-4 eingetragen.
- b) Der Zweck des Emittenten ist die Entwicklung und Vermarktung von Sensortechnologien und künstlicher Intelligenz für autonome Fahrzeuge und andere Anwendungen.
- c) Die Hauptaktionäre der Emittentin sind:
- Global Innovation Partners Limited, Britische Jungferninseln, mit den Mehrheitsaktionären Dr. Daniel Hyman, Mahesh Reddy, Dr. Reginald Tang und Mark Hyman
- d) Der Verwaltungsrat der Emittentin besteht aus:
- Dr. Daniel Hyman, Staatsangehörigkeit: Vereinigte Staaten, Postanschrift: Long Beach, Kalifornien, USA
  - Mahesh Reddy, Staatsangehörigkeit: Vereinigte Staaten, Postanschrift: Irvine, Kalifornien, USA
  - Marcel Füssinger, Staatsangehörigkeit: Österreich, Postanschrift: 160009, Singapur
  - Revalier AG, vertreten durch Reinhold Wohlwend, Staatsangehörigkeit: Liechtenstein, Postanschrift: 9490, Vaduz, Liechtenstein
- e) Die Revisionsstelle ist: Lucas Tihanyi, Mitglied der liechtensteinischen Wirtschaftsprüfervereinigung und EXPERTsuisse, Industriering 14, 9491 Ruggell, Liechtenstein

### 2.2 Welches sind die wesentlichen Finanzinformationen über den Emittenten?

Die Emittentin wurde am 30.11.2023 durch Eintragung in das Handelsregister des Fürstentums Liechtenstein gegründet. Gemäss der Erklärung des Verwaltungsrates vom 25. Oktober 2023 unterliegt die Emittentin keiner ordentlichen Revision und ist nicht Gegenstand einer prüferischen Durchsicht. Die Jahresrechnung per 31. Dezember 2023 und der Zwischenabschluss per 15. Juli 2023 wurden jedoch durch die Revisionsstelle geprüft.

Die folgenden Finanzkennzahlen wurden in Übereinstimmung mit den Bestimmungen des liechtensteinischen Personen- und Gesellschaftsrechts ("PGR"), insbesondere Art. 1024 ff.

#### Gewinn- und Verlustrechnung

	31/12/2023	15/07/2024
<b>Einnahmen insgesamt</b>	0 USD	0 USD
<b>Betriebsgewinn/-verlust</b>	USD -2'473.03	USD -30'150.54
<b>Nettogewinn/-verlust</b>	USD -2'473.03	USD -30'150.54

#### Bilanz

	31/12/2023	15/07/2024
<b>Gesamtvermögen</b>	USD 50'184.35	USD 75'244.30
<b>Eigenkapital insgesamt</b>	47.526,97 USD	USD 19'849.46
<b>Nettofinanzschulden (langfristige Schulden plus kurzfristige Schulden minus Barmittel)</b>	0 USD	0 USD

#### Kapitalflussrechnung

2.2.1

			<b>31/12/2023</b>	<b>15/07/2024</b>
		<b>Relevanter Netto-Cashflow aus betrieblicher Tätigkeit</b>	0 USD	0 USD
		<b>Relevanter Netto-Cashflow aus Investitionstätigkeit</b>	0 USD	0 USD
		<b>Relevanter Nettomittelfluss aus Finanzierungstätigkeit</b>	0 USD	0 USD
	Die Aussichten der Emittentin haben sich seit dem Zwischenbilanzstichtag zum 15.07.2024 nicht wesentlich verschlechtert. Seit dem Stichtag der Zwischenbilanz zum 15.07.2024 haben sich keine wesentlichen Veränderungen in der Finanzlage oder der Handelsposition der Emittentin ergeben.			
<b>2.3</b>	<b>Welche sind die zentralen Risiken, die dem Emittenten eigen sind?</b>			
<b>2.3.1</b>	<p><b>Geringes Kapital</b> Der Zweck der Emittentin ist die Kommerzialisierung der Technologie von AWEARE. Das Eigenkapital der Emittentin ist auf USD 50.000,00 beschränkt, wobei das nach liechtensteinischem Recht erforderliche Mindestkapital USD 50.000,00 beträgt. Da die Emittentin am 30.11.2023 gegründet wurde, stehen neben den in Abschnitt 2.2.1 dieser Zusammenfassung genannten historischen Finanzinformationen keine wesentlichen historischen Finanzdaten oder Kennzahlen zur Verfügung, um die finanzielle Situation der Emittentin in Bezug auf die vergangenen Jahre zu beurteilen. Die Emittentin unterliegt keiner ordentlichen Revision und wird auch nicht von einer Revisionsstelle geprüft. Die Emittentin wurde nicht von einer Rating-Agentur bewertet. Geringes Eigenkapital stellt ein erhöhtes Risiko für den Anleger dar, da die Funktion als haftendes Kapital entsprechend reduziert ist.</p> <p><b>Risiko der Zahlungsunfähigkeit</b> Im Falle der Eröffnung eines Insolvenzverfahrens über das Vermögen der Emittentin wird die Emittentin vorübergehend oder dauerhaft in der Verfügung über ihr Vermögen beschränkt sein, oder die Verfügung über das Vermögen der Emittentin wird von einem gerichtlich bestellten Insolvenzverwalter übernommen. Dies kann sich negativ auf die Finanzlage und die Geschäftstätigkeit der Emittentin auswirken. Dieser Fall kann auch dann eintreten, wenn die Insolvenzanträge fehlerhaft gestellt wurden. Im Falle der Insolvenz der Emittentin haften die Teilnehmer mit ihrem investierten Kapital. Das investierte Kapital ist wie Eigenkapital zu behandeln und daher qualifiziert nachrangig.</p> <p><b>Finanzierung von Unternehmen</b> Es gibt kein Mindestkapital, das aufgebracht werden muss. Es gibt keine Platzierungsgarantie, sondern nur das Risiko, dass die AWEARE Global Tokens nicht vollständig gezeichnet werden (Platzierungsrisiko). Sollte es der Emittentin nicht gelingen, das gewünschte Emissionsvolumen einzuwerben, kann die Emittentin weniger investieren. Es besteht das Risiko einer Kapitalunterdeckung für die Emittentin. Darüber hinaus verbleiben die Emissionskosten, die unabhängig von der Höhe des eingeworbenen Kapitals sind, was die Kostenquote im Verhältnis zum eingeworbenen Gesamtinvestitionskapital erhöht. Es besteht das Risiko, dass die Emittentin in diesem Fall ihre beabsichtigten Anlageziele nicht erreicht und ihren Verpflichtungen aus den AWEARE Global Tokens nicht nachkommen kann.</p> <p><b>Management, Technologie, Abhängigkeit von Drittanbietern, Wettbewerb und Entwicklungszeitrahmen</b> Eine der Hauptstärken des Emittenten ist die geschickte Nutzung der neuesten Radartechnologie. Technische Vorteile in der Informations- und Kommunikationstechnologiebranche können jedoch von kurzer Dauer sein. Dementsprechend wird der Erfolg der Emission zum Teil von ihrer Fähigkeit abhängen, die Dienstleistungen der Emittentin zu verwalten und zu erweitern und die Nutzerbasis ihres Geschäfts zu vergrößern und somit Einnahmen zu erzielen, die den sich ändernden Technologien, den Anforderungen der Nutzer und der Drittanbieter von Dienstleistungen sowie dem Wettbewerbsdruck entsprechen. Wenn dies nicht gelingt oder sich verzögert, kann sich dies negativ auf den Erfolg der Emittentin auswirken.</p> <p><b>Menschliche Fehler bei intelligenten Verträgen</b> Die Emittentin übernimmt keine Haftung und gibt keine Zusicherungen oder Gewährleistungen hinsichtlich der Funktionsfähigkeit des Projekts der Emittentin oder von Smart Contracts, die für die Abwicklung des Angebots im Sinne dieses Prospekts im weitesten Sinne programmiert oder verwendet werden können. Die Anleger können dadurch Wertminderungen erleiden oder generell einen Totalverlust erleiden. In solchen Szenarien können jedoch rechtliche Mechanismen greifen, um einen Anleger vor Verlusten zu schützen.</p>			
<b>ABSCHNITT 3 - BASISINFORMATIONEN ÜBER DIE WERTPAPIERE</b>				
<b>3.1</b>	<b>Was sind die wichtigsten Merkmale der Wertpapiere?</b>			
<b>3.1.1</b>	<b>Informationen über die Wertpapiere</b>			
<b>a)</b>	<b>Beschreibung der Art und Gattung der Wertpapiere</b>	Bei den von der Emittentin öffentlich angebotenen <b>1.400.000</b> neuen Partizipationsscheinen handelt es sich um auf den Inhaber lautende		

		stimmrechtslose Partizipationsscheine im Nennbetrag von je <b>USD 0,01</b> des Partizipationskapitals (die " <b>AWEARE Global Tokens</b> ") aus einer von einer außerordentlichen Hauptversammlung am 18.07.2024 beschlossenen Neuemission von Partizipationskapital. Die Inhaber von AWEARE Global Tokens werden als " <b>Teilnehmer</b> " oder " <b>Tokenholder</b> " bezeichnet.
b)	<b>Währung der Wertpapieremission</b>	United States Dollar (" <b>USD</b> " oder " <b>\$</b> "). Die Laufzeit des AWEARE Global Token ist unbegrenzt.
c)	<b>Beschreibung der mit den Wertpapieren verbundenen Rechte</b>	<p><b>Wahlrecht</b> AWEARE Global Tokens sind stimmrechtslose Partizipationsscheine und berechtigen den Teilnehmer nicht zur Stimmabgabe, zur Einberufung und zur Teilnahme an der Hauptversammlung der Emittentin. AWEARE Global Tokens gewähren ferner kein Auskunfts-, Einsichts- und Antragsrecht. Es kann jedoch ein schriftliches Auskunfts- oder Einsichtsbegehren oder ein Antrag auf Einleitung einer behördlichen Prüfung an die Generalversammlung gerichtet werden.</p> <p><b>Bekanntmachung der Einberufung und der Beschlüsse der Hauptversammlung</b> Den Teilnehmern ist die Einberufung der Hauptversammlung unter Angabe der Gegenstände der Tagesordnung und der Anträge mitzuteilen. Jeder Beschluss der Hauptversammlung ist den Teilnehmern unverzüglich am Sitz der Emittentin zur Einsichtnahme auszulegen. Hierauf sind die Teilnehmer in der Einberufung hinzuweisen.</p> <p><b>Anspruch auf Dividende und Anteil am Liquidationserlös</b> AWEARE Global Tokens sind ab dem Zeitpunkt des wirksamen Erwerbs voll dividendenberechtigt und berechtigen zu einer Beteiligung am Liquidationserlös im Verhältnis der Beteiligung am Partizipationskapital. Die Emittentin plant derzeit keine Dividendenausschüttung in naher Zukunft. Obwohl satzungsgemäß ein Anspruch auf Dividenden besteht, werden keine Prognosen über zukünftige Dividendenausschüttungen gemacht. Die Emittentin beabsichtigt, Gewinne in das weitere Wachstum und die Entwicklung des Unternehmens zu reinvestieren.</p> <p><b>Form und Verbriefung</b> AWEARE Global Tokens werden als Token ausgegeben. Token sind Wertrechte, die auf einer dezentralen Datenbank (Blockchain) ausgegeben und dort übertragen werden. Die für diesen Zweck verwendete Blockchain ist die Ethereum Blockchain.</p> <p><b>Ausschluss von Bezugs- und Beteiligungsrechten</b> Bis zum Erreichen des angestrebten Partizipationskapitals von USD 50'000 sind die Vorzugsrechte gemäss Artikel 304d, 304f und 304g PCL, insbesondere die Zeichnungsrechte und die Mitwirkungsrechte der Teilnehmer, ausgeschlossen.</p> <p><b>Übertragbarkeit der Wertpapiere</b> Die Übertragung (z.B. Abtretung im engeren Sinne, Verpfändung, Vererbung) von AWEARE Global Tokens bedarf der Zustimmung des Verwaltungsrats der Emittentin. Die Übertragbarkeit ist daher in gewissem Umfang eingeschränkt. Eine Übertragung von AWEARE Global Tokens ist jedenfalls dann nicht zulässig, wenn diese dann von einer Person in einem Land gehalten würden, in dem AWEARE Global Tokens nicht angeboten werden dürfen. Eine Übertragung im vorgenannten Sinne liegt auch dann vor, wenn ein Tokenholder seinen Wohnsitz in ein Land verlegt, in dem AWEARE Global Tokens nicht angeboten werden dürfen.</p>
d)	<b>Relativer Vorrang der Wertpapiere in der Kapitalstruktur des Emittenten im Falle einer Insolvenz</b>	Im Falle der Insolvenz der Emittentin haften die Teilnehmer mit ihrem investierten Kapital. Das investierte Kapital ist wie Eigenkapital zu behandeln und ist daher qualifiziert nachrangig.
e)	<b>Beschreibung der Dividendenpolitik</b>	Bislang wurden keine Dividenden gezahlt. Der Emittent macht keine Gewinnprognosen oder -schätzungen und daher wird keine Beschreibung der Dividendenpolitik vorgenommen. Etwaige Dividenden werden in USD gezahlt. Die Emittentin behält sich das Recht vor, Dividenden auch in anderen Währungen oder Kryptowährungen zu zahlen. Jeder Beschluss zur Zahlung von Dividenden wird im Einklang mit geltendem Recht gefasst und hängt unter anderem von der Ertragslage, der Finanzlage, vertraglichen Beschränkungen und dem Kapitalbedarf der Emittentin ab. In jedem Fall werden 5 % des Nettogewinns den gesetzlichen Rücklagen zugeführt, bis diese die Höhe von 10 % des eingezahlten Grundkapitals erreicht haben.
3.2	<b>Wo werden die Wertpapiere gehandelt?</b>	

3.2.1	AWEARE Global Tokens sind nicht zum Handel an einem geregelten Markt zugelassen. Die Emittentin behält sich das Recht vor, die Zulassung zum Handel an einem geregelten Markt zu beantragen.
3.4	<b>Welche sind die zentralen Risiken, die den Wertpapieren eigen sind?</b>
3.4.1	<p><b>Geldbörse des Investors und Risiko des privaten Schlüssels</b> Das Risiko der Auswahl der Wallet bzw. des Verbleibs des privaten Schlüssels trägt allein der Anleger. Wird eine inkompatible Wallet verwendet oder geht der private Schlüssel verloren, ist der Zugang zu den AWEARE Global Tokens in der Regel nicht möglich. Die Folgen, wie z.B. der Totalverlust der Investition, sind allein vom Anleger zu tragen.</p> <p><b>Risiko der Veräußerbarkeit, Liquiditäts- und Verwertungsrisiko</b> Es gibt keine Gewissheit, dass sich ein liquider Markt für die AWEARE Global Tokens entwickeln wird. Infolgedessen könnten die AWEARE Global Tokens nicht auf einem Sekundärmarkt verkauft werden, was ein Liquiditätsrisiko für den Anleger darstellt.</p> <p><b>Volatilitätsrisiko</b> Es bestehen Risiken im Zusammenhang mit der Volatilität des Aktienkurses. Sollten AWEARE Global Tokens verkauft werden und in eine starke Kursschwankung nach unten geraten, könnte der Tokenholder durch den Verkauf zum Teil erhebliche Verluste erleiden.</p> <p><b>Verlust von Wertmarken</b> Token können verloren gehen oder unzugänglich werden, insbesondere wenn der Tokeninhaber den jeweiligen privaten Schlüssel zur Verfügung über seine AWEARE Global Token verliert oder aufgrund einer Fehlfunktion des e-Wallets, in dem die AWEARE Global Token gespeichert sind. Dies kann zum Verlust der Token führen. Es liegt in der alleinigen Verantwortung des Token-Inhabers, den privaten Schlüssel, der den Zugriff auf die elektronische Geldbörse ermöglicht, sicher aufzubewahren und zu schützen. Token können auch im Todesfall eines Tokeninhabers unzugänglich werden, wenn er oder sie keine Vorkehrungen für diesen Fall getroffen hat. Weder die Emittentin noch irgendeine andere Stelle oder Institution ist in der Lage, den Zugang zum Wallet des Token-Inhabers für die Nachfolger des Token-Inhabers wiederherzustellen. Der Verlust privater Schlüssel könnte darüber hinaus die Verfügbarkeit verschiedener Funktionalitäten der STO und der AWEARE Global Tokens beeinträchtigen. Insbesondere kann es unmöglich sein, AWEARE Global Tokens an Abonnenten auszugeben oder sie übertragbar zu machen, wodurch sie auf unbestimmte Zeit pausieren würden. Außerdem kann es unmöglich sein, Dividendenzahlungen vorzunehmen. Schließlich besteht das Risiko, dass ein Angreifer AWEARE Global Tokens für nicht beitragszahlende Adressen prägt, den Bestätigungsstatus ändert, unkontrollierte Beträge in die STO einzahlt oder es dem Angreifer ermöglicht, nicht beanspruchte Dividendenzahlungen abzuheben.</p> <p><b>Eingeschränkte Rechte der Tokeninhaber</b> AWEARE Global Tokens sind stimmrechtslose Genussscheine und berechtigen die Tokeninhaber nicht zur Stimmabgabe, zur Einberufung und zur Teilnahme an der Hauptversammlung der Emittentin. Darüber hinaus gewähren AWEARE Global Tokens kein Auskunfts-, Einsichts- und Antragsrecht. Die Hauptversammlung der Emittentin kann daher Beschlüsse fassen, die sich nachteilig auf die Rechte der Tokeninhaber auswirken können. Tokenholder haben keine Möglichkeit, die Verwendung der Erlöse aus der Emission von AWEARE Global Tokens zu kontrollieren. Die Übertragung (z.B. Übertragung im engeren Sinne, Verpfändung, Vererbung) von AWEARE Global Tokens bedarf der Zustimmung des Verwaltungsrats der Emittentin. Eine Übertragung von AWEARE Global Tokens ist jedenfalls dann nicht zulässig, wenn diese dann von einer Person in einem Land gehalten werden, in dem AWEARE Global Tokens nicht angeboten werden dürfen. Eine Übertragung im vorgenannten Sinne liegt auch dann vor, wenn ein Tokenholder seinen Wohnsitz in ein Land verlegt, in dem AWEARE Global Tokens nicht angeboten werden dürfen. Das gesetzliche Bezugsrecht der Tokeninhaber im Falle einer Kapitalerhöhung unter diesem Angebot ist ausgeschlossen.</p> <p><b>Die Ansprüche der Tokeninhaber sind nachrangig</b> . Die Ansprüche der Tokeninhaber auf Dividendenzahlungen von der Emittentin sind nachrangig gegenüber den Ansprüchen aller Inhaber von nicht nachrangigen Verbindlichkeiten der Emittentin. Im Falle einer Liquidation der Emittentin werden die Tokeninhaber nur dann ausgezahlt, wenn und nachdem alle vorrangigen Verpflichtungen der Emittentin erfüllt wurden.</p>
<b>ABSCHNITT 4 - BASISINFORMATIONEN ÜBER DAS ÖFFENTLICHE ANGEBOT VON WERTPAPIEREN</b>	
4.1	<b>Unter welchen Bedingungen und nach welchem Zeitplan kann ich in dieses Wertpapier investieren?</b>
<p><b>Länder, in denen die Wertpapiere angeboten werden</b> Das Angebot besteht aus öffentlichen Angeboten in Belgien, Bulgarien, Dänemark, Deutschland, Estland, Finnland, Frankreich, Griechenland, Irland, Island, Italien, Kroatien, Lettland, Liechtenstein, Litauen, Luxemburg, Malta, den Niederlanden, Norwegen, Österreich, Polen, Portugal, Rumänien, Schweden, der Schweiz, der Slowakei, Slowenien, Spanien, der Tschechischen Republik, Ungarn und Zypern sowie aus Privatplatzierungen in bestimmten Ländern außerhalb dieser Länder.</p> <p><b>Länder, in denen die Wertpapiere nicht angeboten werden</b> AWEARE Global Tokens des Emittenten sind nicht und werden nicht gemäß den Bestimmungen des United States Securities Act von 1933 in seiner jeweils gültigen Fassung oder bei den Wertpapieraufsichtsbehörden eines Bundesstaates der Vereinigten Staaten von Amerika oder in Australien, Japan oder Kanada registriert. Dementsprechend werden sie weder</p>	

direkt noch indirekt öffentlich angeboten, verkauft oder geliefert, es sei denn, es liegt eine Ausnahme von den Registrierungsanforderungen vor. Insbesondere stellt dieser Prospekt kein Angebot zum Verkauf oder eine Aufforderung zur Abgabe eines Angebots zum Kauf von AWEARE Global Tokens in den Vereinigten Staaten von Amerika, Australien, Japan und Kanada dar und darf dort nicht verteilt werden. Darüber hinaus stellt dieser Prospekt weder ein Angebot zum Verkauf noch eine Aufforderung zum Kauf von AWEARE Global Tokens in Russland, Iran, Nordkorea, Weißrussland, Syrien oder einem dieser Länder dar. Und darf dort nicht verteilt werden.

#### **Bieten**

Der Zeichnungsprozess für AWEARE Global Tokens findet online unter <https://kyc.awearetech.li/> (das "Dashboard") statt.

#### **Angebotszeitraum**

Der Zeitraum, in dem Anleger ihre Kaufangebote für AWEARE Global Tokens abgeben können, beginnt mit dem Datum der Billigung des Prospekts und endet ein Jahr später (die "Angebotsfrist"). Am letzten Tag der Angebotsfrist können Angebote bis 12:00 Uhr liechtensteinischer Zeit abgegeben werden.

#### **Angebotspreis**

Der Angebotspreis für einen AWEARE-Token beträgt **USD 12,00** (der "Angebotspreis").

Als Anreiz für eine frühzeitige Investition werden die folgenden Rabatte gewährt:

Für Investitionen zwischen 10.000 USDC und 49.999,99 USDC erhalten Investoren einen Rabatt von 10%, so dass der Preis pro AWEARE Token 10,80 USD beträgt.

Bei einer Investition von 50.000 USDC oder mehr erhalten Investoren einen Rabatt von 15%, so dass der Preis pro AWEARE Token 10,20 USD beträgt.

#### **Verfügbarkeit der Ermäßigungen**

Die oben genannten Ermäßigungen gelten **bis zum Eintreten eines der folgenden Ereignisse, je nachdem, was zuerst eintritt:**

- Erreichen eines Gesamtinvestitionsvolumens von **5.000.000 USDC**, oder
- Ablauf von **drei Monaten ab dem Beginn des Angebots**.

#### **Lieferung und Abrechnung**

Jeder Anleger muss den Online-Zeichnungsprozess auf dem Dashboard abschließen. Die Zuteilung der AWEARE Global Tokens erfolgt off-chain als Datensatz in der Datenbank der Emittentin, der über das Dashboard einsehbar ist, gegen Zahlung des Angebotspreises. Die Zuteilung der AWEARE Global Tokens erfolgt on-chain im Smart Contract spätestens innerhalb von zwei Monaten nach Ende der Angebotsfrist. Sobald das Gesamtangebot an AWEARE Global Tokens (nach Erreichen des angestrebten Beteiligungskapitals) beendet ist und die Emittentin beschlossen hat, den Smart Contract zu finalisieren, werden die AWEARE Global Tokens an die Krypto-Wallet des Investors geliefert.

#### **Verdünnung**

Da das gesetzliche Bezugsrecht aller Teilnehmer im Falle einer Kapitalerhöhung im Rahmen dieses Angebots ausgeschlossen ist, werden die Teilnehmer dieses Angebots nicht verwässert.

#### **Gesamte Nettoerlöse und geschätzte Emissionskosten**

Der gesamte Nettoerlös des Angebots über 1.400.000 AWEARE Global Tokens kann sich auf etwa **15.000.000 USD** belaufen, was der Durchführung der Kapitalerhöhung entspricht. Die erwarteten Gesamtkosten des Angebots belaufen sich auf ca. **1.500.000 USD** und werden von den Erlösen abgezogen.

<b>4.2</b>	<b>Warum wird dieser Prospekt erstellt?</b>
<b>4.2.1</b>	<p>a) Der geschätzte Nettoerlös aus der Emission der Wertpapiere wird in erster Linie für Forschung und Entwicklung sowie den Schutz des geistigen Eigentums verwendet. Bei Bedarf kann es erforderlich sein, bis zu 50 % eines zugewiesenen Budgets auf einen anderen Posten zu übertragen.</p> <ul style="list-style-type: none"> <li>i) 10% Kosten der Anhebung</li> <li>ii) 11% Allgemeines und Verwaltung</li> <li>iii) 41% Forschung und Entwicklung</li> <li>iv) 17% Rechtliche Aspekte (globaler Schutz des geistigen Eigentums)</li> <li>v) 21% Geschäftsentwicklung, Vertrieb und Marketing</li> </ul> <p>b) Zu den derzeitigen Aktionären von AWEARE Technologies Inc. und Global Innovation Partners Limited gehören Mahesh Reddy und Dr. Daniel Hyman. Mahesh Reddy und Dr. Daniel Hyman sind auch Direktoren und Minderheitsaktionäre der Emittentin.</p> <p>c) Die Equanimity AG erhält eine Transaktionsgebühr von 3% der gesamten angefallenen Kryptowährungen und Fiat-Zahlungen. Marcel Füssinger, einer der Direktoren der Emittentin, ist auch Direktor und Eigentümer der Equanimity AG.</p> <p>d) <b>Gesamte Nettoerlöse und geschätzte Emissionskosten</b> Der gesamte Nettoerlös des Angebots über 1.400.000 AWEARE Global Tokens kann sich auf etwa <b>15.000.000 USD</b> belaufen, was der Durchführung der Kapitalerhöhung entspricht. Die voraussichtlichen</p>

	<p>Gesamtkosten des Angebots belaufen sich auf ca. <b>1.500.000 USD</b> und werden von den Erlösen abgezogen.</p> <p>e) <b>Versicherungstechnische Arrangements</b>  Das Angebot ist nicht Gegenstand eines festen Übernahmevertrags. Es gibt keine Vereinbarung, nach der ein Underwriter verpflichtet ist, nicht verkaufte Token zu zeichnen. Daher gibt es keine Garantie, dass das gesamte Angebot platziert wird.</p>
--	--

### III. NOTA DI SINTESI DEL PROSPETTO

Questa nota di sintesi contiene tutti gli elementi necessari per essere incluso in un riepilogo per questo tipo di titoli ed emittente.

SEZIONE 1 - INTRODUZIONE		
1.1	Nome e ISIN dei titoli	I <b>1.400.000</b> nuovi certificati di partecipazione sono certificati di partecipazione al portatore senza diritto di voto di AWEARE Global AG. Il nome di questi certificati di partecipazione è " <b>AWEARE Global Tokens</b> ". L'ISIN è LI1363014385.
1.2	Identità e dati di contatto dell'emittente, compreso l'identificativo dell'entità legale (LEI)	<b>AWEARE Global AG</b> ("Emittente") c/o Revalier Aktiengesellschaft Pradafant 11, 9490 Vaduz, Principato di Tel: +423 237 63 47 Email: <a href="mailto:info@awearetech.li">info@awearetech.li</a> Il LEI è: 391200PTNEZNXGJW1C39
1.3	Autorità competente	<b>Autorità dei mercati finanziari</b> (la "FMA") Landstrasse 109, 9490 Vaduz, Principato del Liechtenstein Tel: +423 236 73 73 Fax: +423 236 73 74 Email: <a href="mailto:info@fma-li.li">info@fma-li.li</a>
1.4	Data di approvazione del prospetto	05/12/2024
1.5	<b>Avvertenze</b>	
1.5.1	<p>a) La sintesi deve essere letta come introduzione al presente Prospetto informativo. Qualsiasi decisione di investire nei titoli deve basarsi sulla considerazione del Prospetto informativo nel suo complesso da parte dell'investitore.</p> <p>b) L'investitore potrebbe perdere tutto o parte del capitale investito.</p> <p>c) Quando un reclamo relativo alle informazioni contenute nel prospetto viene portato in tribunale, l'investitore ricorrente potrebbe, in base al diritto nazionale, dover sostenere le spese di traduzione del prospetto prima dell'avvio del procedimento giudiziario.</p> <p>d) La responsabilità civile riguarda solo le persone che hanno presentato la nota di sintesi, comprese le relative traduzioni, ma solo se la nota di sintesi è fuorviante, imprecisa o incoerente, se letta insieme con le altre parti del Prospetto o non fornisce, se letta insieme con le altre parti del Prospetto, informazioni fondamentali per aiutare gli investitori a valutare se investire negli strumenti finanziari.</p>	
SEZIONE 2 - INFORMAZIONI CHIAVE SULL'EMITTENTE		
2.1	<b>Chi è l'emittente dei titoli?</b>	
2.1.1	<b>Informazioni sull'emittente</b>	
	<p>a) La denominazione legale e commerciale dell'Emittente è "AWEARE Global AG". L'Emittente è una società per azioni costituita nel Principato del Liechtenstein e regolata dalle leggi del Principato del Liechtenstein. L'Emittente ha la propria sede legale a Vaduz, nel Principato del Liechtenstein, ed è registrata presso l'Ufficio di Giustizia / Registro Commerciale del Principato del Liechtenstein con il numero di registrazione FL-0002.714.015-4.</p> <p>b) Lo scopo dell'Emittente è quello di sviluppare e monetizzare tecnologie di sensori e intelligenza artificiale per veicoli autonomi e altre applicazioni.</p> <p>c) I principali azionisti dell'Emittente sono: <ul style="list-style-type: none"> <li>Global Innovation Partners Limited, Isole Vergini Britanniche, con gli azionisti di maggioranza Dr. Daniel Hyman, Mahesh Reddy, Dr. Reginald Tang e Mark Hyman.</li> </ul> </p> <p>d) Il Consiglio di Amministrazione dell'Emittente è composto da:</p>	

	<ul style="list-style-type: none"> <li>• Dr. Daniel Hyman, Nazionalità: Stati Uniti, Indirizzo postale: Long Beach, California, USA</li> <li>• Mahesh Reddy, Nazionalità: Stati Uniti, Indirizzo postale: Irvine, California, USA</li> <li>• Marcel Füssinger, Nazionalità: Austria, Indirizzo postale: 160009, Singapore</li> <li>• Revalier AG rappresentata da Reinhold Wohlwend, Nazionalità: Liechtenstein, Indirizzo: 9490, Vaduz, Liechtenstein</li> </ul> <p>e) Il revisore dei conti è: Lucas Tihanyi, Membro dell'Associazione dei Revisori dei Conti del Liechtenstein e di EXPERTsuisse, Industriering 14, 9491 Ruggell, Liechtenstein.</p>																																				
<b>2.2</b>	<b>Quali sono le principali informazioni finanziarie relative all'emittente?</b>																																				
<b>2.2.1</b>	<p>L'Emittente è stata fondata il 30/11/2023 mediante iscrizione nel registro delle imprese del Principato del Liechtenstein. Secondo la dichiarazione del Consiglio di Amministrazione del 25 ottobre 2023, l'Emittente non è soggetta a revisione ordinaria e non è soggetta a revisione contabile. Tuttavia, il bilancio annuale al 31 dicembre 2023 e il bilancio intermedio al 15 luglio 2023 sono stati sottoposti a revisione da parte del Revisore.</p> <p>Le seguenti informazioni finanziarie chiave sono state redatte in conformità alle disposizioni della Legge sulle persone e sulle società del Liechtenstein ("PCL"), in particolare agli artt. 1024 e seguenti.</p> <p style="text-align: center;"><b>Conto economico</b></p> <table border="1"> <thead> <tr> <th></th> <th style="text-align: center;">31/12/2023</th> <th style="text-align: center;">15/07/2024</th> </tr> </thead> <tbody> <tr> <td><b>Ricavi totali</b></td> <td style="text-align: center;">USD 0</td> <td style="text-align: center;">USD 0</td> </tr> <tr> <td><b>Utile/perdita operativa</b></td> <td style="text-align: center;">USD -2'473.03</td> <td style="text-align: center;">USD -30'150.54</td> </tr> <tr> <td><b>Utile/perdita netta</b></td> <td style="text-align: center;">USD -2'473.03</td> <td style="text-align: center;">USD -30'150.54</td> </tr> </tbody> </table> <p style="text-align: center;"><b>Bilancio</b></p> <table border="1"> <thead> <tr> <th></th> <th style="text-align: center;">31/12/2023</th> <th style="text-align: center;">15/07/2024</th> </tr> </thead> <tbody> <tr> <td><b>Totale attività</b></td> <td style="text-align: center;">50'184.35 USD</td> <td style="text-align: center;">75'244.30 USD</td> </tr> <tr> <td><b>Patrimonio netto totale</b></td> <td style="text-align: center;">47.526,97 USD</td> <td style="text-align: center;">19'849.46 USD</td> </tr> <tr> <td><b>Indebitamento finanziario netto (debiti a lungo termine più debiti a breve termine meno la liquidità)</b></td> <td style="text-align: center;">USD 0</td> <td style="text-align: center;">USD 0</td> </tr> </tbody> </table> <p style="text-align: center;"><b>Rendiconto finanziario</b></p> <table border="1"> <thead> <tr> <th></th> <th style="text-align: center;">31/12/2023</th> <th style="text-align: center;">15/07/2024</th> </tr> </thead> <tbody> <tr> <td><b>Flussi di cassa netti rilevanti da attività operative</b></td> <td style="text-align: center;">USD 0</td> <td style="text-align: center;">USD 0</td> </tr> <tr> <td><b>Flussi di cassa netti rilevanti da attività di investimento</b></td> <td style="text-align: center;">USD 0</td> <td style="text-align: center;">USD 0</td> </tr> <tr> <td><b>Netto rilevante Flussi di cassa da attività di finanziamento</b></td> <td style="text-align: center;">USD 0</td> <td style="text-align: center;">USD 0</td> </tr> </tbody> </table> <p>Le prospettive dell'Emittente non si sono deteriorate in modo significativo dalla data di riferimento del bilancio intermedio al 15/07/2024. Non si sono verificati cambiamenti significativi nella situazione finanziaria o commerciale dell'Emittente dalla data di riferimento del bilancio intermedio al 15/07/2024.</p>		31/12/2023	15/07/2024	<b>Ricavi totali</b>	USD 0	USD 0	<b>Utile/perdita operativa</b>	USD -2'473.03	USD -30'150.54	<b>Utile/perdita netta</b>	USD -2'473.03	USD -30'150.54		31/12/2023	15/07/2024	<b>Totale attività</b>	50'184.35 USD	75'244.30 USD	<b>Patrimonio netto totale</b>	47.526,97 USD	19'849.46 USD	<b>Indebitamento finanziario netto (debiti a lungo termine più debiti a breve termine meno la liquidità)</b>	USD 0	USD 0		31/12/2023	15/07/2024	<b>Flussi di cassa netti rilevanti da attività operative</b>	USD 0	USD 0	<b>Flussi di cassa netti rilevanti da attività di investimento</b>	USD 0	USD 0	<b>Netto rilevante Flussi di cassa da attività di finanziamento</b>	USD 0	USD 0
	31/12/2023	15/07/2024																																			
<b>Ricavi totali</b>	USD 0	USD 0																																			
<b>Utile/perdita operativa</b>	USD -2'473.03	USD -30'150.54																																			
<b>Utile/perdita netta</b>	USD -2'473.03	USD -30'150.54																																			
	31/12/2023	15/07/2024																																			
<b>Totale attività</b>	50'184.35 USD	75'244.30 USD																																			
<b>Patrimonio netto totale</b>	47.526,97 USD	19'849.46 USD																																			
<b>Indebitamento finanziario netto (debiti a lungo termine più debiti a breve termine meno la liquidità)</b>	USD 0	USD 0																																			
	31/12/2023	15/07/2024																																			
<b>Flussi di cassa netti rilevanti da attività operative</b>	USD 0	USD 0																																			
<b>Flussi di cassa netti rilevanti da attività di investimento</b>	USD 0	USD 0																																			
<b>Netto rilevante Flussi di cassa da attività di finanziamento</b>	USD 0	USD 0																																			
<b>2.3</b>	<b>Quali sono i principali rischi specifici dell'emittente?</b>																																				
<b>2.3.1</b>	<p><b>Basso capitale</b></p> <p>Lo scopo dell'Emittente è la commercializzazione della tecnologia di AWEARE. Il capitale proprio dell'Emittente è limitato a 50.000,00 USD, laddove il capitale minimo richiesto dalla legge del Liechtenstein è di 50.000,00 USD. Poiché l'Emittente è stato costituito il 30/11/2023, non sono disponibili dati finanziari storici significativi o cifre chiave, oltre alle informazioni finanziarie storiche di cui alla sezione 2.2.1 della presente sintesi, per valutare la</p>																																				



<p>situazione finanziaria dell'Emittente in relazione agli anni passati. L'Emittente non è soggetto a revisione contabile ordinaria e non è sottoposto a revisione contabile. L'Emittente non è stato valutato da un'agenzia di rating. Un basso livello di capitale proprio rappresenta un maggior rischio per l'investitore, in quanto la funzione di capitale responsabile è corrispondentemente ridotta.</p> <p><b>Rischio di insolvenza</b> In caso di apertura di una procedura di insolvenza sui beni dell'Emittente, l'Emittente sarà temporaneamente o permanentemente limitato nella cessione dei suoi beni, o la cessione dei beni dell'Emittente sarà presa in carico da un curatore fallimentare nominato dal tribunale. Ciò potrebbe avere un impatto negativo sulla situazione finanziaria e sulle attività dell'Emittente. Questo caso può verificarsi anche se le domande di insolvenza sono state presentate in modo non corretto. In caso di insolvenza dell'Emittente, i Partecipanti sono responsabili con il loro capitale investito. Il capitale investito deve essere trattato come un capitale proprio ed è quindi subordinato in modo qualificato.</p> <p><b>Finanziamento delle imprese</b> Non c'è un capitale minimo da raccogliere. Non vi è alcuna garanzia di collocamento, ma piuttosto il rischio che i Global Token AWEARE non siano interamente sottoscritti (rischio di collocamento). Se l'Emittente non riesce a sollecitare il volume di emissione desiderato, l'Emittente potrà investire meno. Esiste il rischio di una carenza di capitale per l'Emittente. Inoltre, i costi di emissione, che sono indipendenti dall'ammontare del capitale raccolto, rimarranno, il che aumenterà l'indice di spesa in relazione al capitale di investimento totale raccolto. Vi è il rischio che in questo caso l'Emittente non raggiunga gli obiettivi di investimento previsti e non sia in grado di adempiere ai propri obblighi ai sensi dei Token Globali AWEARE.</p> <p><b>Gestione, tecnologia, affidamento a fornitori di servizi terzi, concorrenza e tempi di sviluppo</b> Uno dei principali punti di forza dell'Emittente è l'uso accorto delle più recenti tecnologie radar. Tuttavia, i vantaggi tecnici nel settore delle tecnologie dell'informazione e della comunicazione possono essere di breve durata. Di conseguenza, il successo dell'emissione dipenderà, in parte, dalla sua capacità di gestire ed espandere i servizi dell'Emittente e di far crescere la base di utenti della sua attività e quindi di generare ricavi in risposta all'evoluzione delle tecnologie, alle richieste degli utenti e dei fornitori di servizi terzi e alle pressioni competitive. Il fallimento o i ritardi in questo senso potrebbero avere un impatto negativo sul successo dell'Emittente.</p> <p><b>Errore umano con i contratti intelligenti</b> L'Emittente non si assume alcuna responsabilità e non rilascia alcuna dichiarazione o garanzia in merito alla funzionalità del progetto dell'Emittente o di qualsiasi smart contract che possa essere programmato o utilizzato per il regolamento dell'offerta in conformità al presente Prospetto informativo in senso lato. Gli investitori potrebbero subire perdite di valore o, in generale, subire una perdita totale. Tuttavia, in tali scenari, possono essere applicati meccanismi legali per proteggere l'investitore dalle perdite.</p>		
<b>SEZIONE 3 - INFORMAZIONI CHIAVE SUGLI STRUMENTI FINANZIARI</b>		
<b>3.1</b>	<b>Quali sono le caratteristiche principali dei titoli?</b>	
<b>3.1.1</b>	<b>Informazioni sui titoli</b>	
<b>a)</b>	<b>Descrizione del tipo e della classe degli strumenti finanziari</b>	I <b>1.400.000</b> nuovi certificati di partecipazione offerti pubblicamente dall'Emittente sono certificati di partecipazione al portatore senza diritto di voto, ciascuno con un valore nominale di <b>USD0,01</b> del capitale di partecipazione (i " <b>Gettoni Globali AWEARE</b> "), provenienti da una nuova emissione di capitale di partecipazione deliberata da un'Assemblea Generale straordinaria il 18/07/2024. I titolari di AWEARE Global Tokens sono chiamati " <b>Partecipanti</b> " o " <b>Titolari di Token</b> ".
<b>b)</b>	<b>Valuta di emissione dei titoli</b>	Dollaro degli Stati Uniti (" <b>USD</b> " o " <b>\$</b> "). La durata del Gettone Globale AWEARE è illimitata.
<b>c)</b>	<b>Descrizione dei diritti connessi ai titoli</b>	<p><b>Diritto di voto</b> I Gettoni Globali AWEARE sono certificati di partecipazione senza diritto di voto e non danno diritto al Partecipante di votare, convocare e partecipare all'Assemblea Generale dell'Emittente. Inoltre, i Gettoni Globali AWEARE non conferiscono il diritto all'informazione, il diritto di ispezione e il diritto di presentare una domanda. Tuttavia, una richiesta scritta di informazioni o di ispezione o di avvio di una revisione ufficiale può essere presentata all'Assemblea Generale.</p> <p><b>Annuncio della convocazione e delle deliberazioni dell'Assemblea</b> I partecipanti devono essere informati della convocazione dell'Assemblea, con l'indicazione degli argomenti all'ordine del giorno e delle proposte. Ogni delibera dell'Assemblea deve essere messa a disposizione dei Partecipanti per la consultazione presso la sede legale dell'Emittente senza indugio. I Partecipanti ne sono informati nell'avviso di convocazione.</p> <p><b>Diritto ai dividendi e quota del ricavato della liquidazione</b> I Global Token AWEARE hanno pieno diritto ai dividendi a partire dalla data di acquisizione valida e danno diritto a una quota dei proventi della liquidazione in</p>

		<p>proporzione alla loro partecipazione al capitale di partecipazione. L'Emittente non prevede attualmente di distribuire dividendi nel prossimo futuro. Sebbene lo Statuto preveda un diritto ai dividendi, non si fanno previsioni su future distribuzioni di dividendi. L'Emittente intende reinvestire gli utili nell'ulteriore crescita e sviluppo della società.</p> <p><b>Forma e cartolarizzazione</b> I Gettoni AWEARE Global saranno emessi sotto forma di gettoni. I token sono diritti di valore che vengono emessi su un database decentralizzato (Blockchain) e ivi trasferiti. La Blockchain utilizzata a questo scopo è la Blockchain di Ethereum.</p> <p><b>Esclusione dei diritti di sottoscrizione e di partecipazione</b> Fino al raggiungimento del capitale di partecipazione target di 50.000 USD, i diritti preferenziali di cui agli articoli 304d, 304f e 304g PCL, in particolare i diritti di sottoscrizione e di partecipazione dei partecipanti, sono esclusi.</p> <p><b>Trasferibilità dei titoli</b> Il trasferimento (come il trasferimento in senso stretto, la costituzione in pegno, l'eredità) di AWEARE Global Token richiede l'approvazione del Consiglio di Amministrazione dell'Emittente. La trasferibilità è pertanto limitata in una certa misura. In ogni caso, un trasferimento dei Gettoni Globali AWEARE non è consentito se essi sarebbero detenuti da una persona in un paese in cui i Gettoni Globali AWEARE non possono essere offerti. Si ritiene che si verifichi un trasferimento nel senso sopra indicato anche nel caso in cui un Titolare di Gettoni sposti la propria residenza in un paese in cui i Gettoni Globali AWEARE non possono essere offerti.</p>
d)	<b>Anzianità relativa dei titoli nella struttura del capitale dell'emittente in caso di insolvenza</b>	In caso di insolvenza dell'Emittente, i Partecipanti rispondono con il loro capitale investito. Il capitale investito deve essere trattato come un capitale proprio ed è quindi subordinato in modo qualificato.
e)	<b>Descrizione della politica dei dividendi</b>	Ad oggi non sono stati pagati dividendi. L'Emittente non fa previsioni o stime sugli utili e pertanto non viene descritta la politica dei dividendi. Gli eventuali dividendi saranno pagati in USD. L'Emittente si riserva il diritto di pagare i dividendi anche in un'altra valuta o criptovaluta. Qualsiasi delibera di pagamento dei dividendi sarà presa in conformità alla legge applicabile e dipenderà, tra l'altro, dai risultati delle operazioni dell'Emittente, dalla sua posizione finanziaria, dalle restrizioni contrattuali e dai requisiti di capitale. In ogni caso, il 5% dell'utile netto sarà destinato alle riserve statutarie fino a raggiungere il 10% del capitale sociale versato.
<b>3.2</b>	<b>Dove saranno negoziati i titoli?</b>	
<b>3.2.1</b>	I Global Token AWEARE non sono ammessi alla negoziazione su un mercato regolamentato. L'Emittente si riserva il diritto di richiedere l'ammissione alla negoziazione su un mercato regolamentato.	
<b>3.4</b>	<b>Quali sono i principali rischi specifici dei titoli?</b>	
<b>3.4.1</b>	<p><b>Portafoglio degli investitori e rischio di chiave privata</b> L'investitore si assume da solo il rischio della selezione del portafoglio o della localizzazione della chiave privata. Se viene utilizzato un portafoglio incompatibile o se la chiave privata viene persa, l'accesso ai Gettoni AWEARE Global è normalmente impossibile. Le conseguenze, come la perdita totale dell'investimento, devono essere sostenute esclusivamente dall'investitore.</p> <p><b>Rischio di vendibilità, liquidità e rischio di realizzo</b> Non vi è alcuna certezza che si sviluppi un mercato liquido per i Gettoni Globali AWEARE. Di conseguenza, i Gettoni Globali AWEARE non potrebbero essere venduti su un mercato secondario, creando un rischio di liquidità per l'investitore.</p> <p><b>Rischio di volatilità</b> Esistono rischi legati alla volatilità del prezzo delle azioni. Se i Gettoni AWEARE Global dovessero essere venduti e si trovasse in una forte fluttuazione di prezzo al ribasso, il possessore dei Gettoni potrebbe subire perdite, alcune delle quali potrebbero essere sostanziali, come risultato della vendita.</p> <p><b>Perdita di gettoni</b> I Gettoni possono essere persi o diventare inaccessibili, in particolare se il Titolare del Gettone perde la rispettiva chiave privata per disporre dei suoi Gettoni AWEARE Global o a causa di un malfunzionamento del portafoglio elettronico in cui sono memorizzati i Gettoni AWEARE Global. Ciò potrebbe comportare la perdita dei Gettoni. È esclusiva responsabilità dei titolari dei Gettoni conservare e proteggere in modo sicuro la chiave privata che consente l'accesso all'e-wallet. I Gettoni possono diventare inaccessibili anche in caso di decesso di un Titolare di Gettoni, se questi non ha preso provvedimenti in tal senso. Né l'Emittente né altri enti o istituzioni saranno in grado di ripristinare l'accesso al portafoglio del Tokenholder per i successori del Tokenholder. La perdita delle chiavi private potrebbe inoltre ridurre la disponibilità di varie funzionalità dell'Ordinanza e dei Token AWEARE Global. In</p>	

	<p>particolare, potrebbe essere impossibile emettere AWEARE Global Tokens ai sottoscrittori o renderli trasferibili, nel qual caso rimarrebbero in pausa a tempo indeterminato. Inoltre, potrebbe essere impossibile effettuare il pagamento dei dividendi. Infine, c'è il rischio che un aggressore possa coniare AWEARE Global Token per indirizzi che non contribuiscono, alterare lo stato di conferma, contribuire con importi non controllati all'ordinanza solare o consentire all'aggressore di ritirare i pagamenti dei dividendi non reclamati.</p> <p><b>I Tokenholder</b> AWEARE Global Token sono certificati di partecipazione senza diritto di voto e non danno diritto ai Tokenholder di votare, convocare e partecipare all'Assemblea Generale dell'Emittente. Inoltre, i Token Globali AWEARE non conferiscono il diritto di informazione, il diritto di ispezione e il diritto di presentare una domanda. L'Assemblea Generale dell'Emittente può quindi adottare delibere che possono pregiudicare i diritti dei Tokenholder. I Portatori dei Token non hanno la possibilità di controllare l'utilizzo dei proventi derivanti dall'emissione dei Token Globali AWEARE. Il trasferimento (come il trasferimento in senso stretto, la costituzione in pegno, l'eredità) di AWEARE Global Token richiede l'approvazione del Consiglio di Amministrazione dell'Emittente. In ogni caso, un trasferimento di AWEARE Global Token non è consentito se questi saranno detenuti da una persona in un paese in cui gli AWEARE Global Token non possono essere offerti. Si ritiene che si verifichi un trasferimento nel senso sopra indicato anche nel caso in cui un Titolare di Gettoni sposti la propria residenza in un paese in cui i Gettoni Globali AWEARE non possono essere offerti. Il diritto di sottoscrizione legale dei Portatori dei Token in caso di aumento di capitale ai sensi della presente offerta è escluso.</p> <p><b>I diritti dei Portatori dei Token sono subordinati</b> Il diritto dei Portatori dei Token di richiedere e ricevere pagamenti di dividendi dall'Emittente è subordinato ai crediti di tutti i titolari di obbligazioni non subordinate dell'Emittente. In caso di liquidazione dell'Emittente, i Portatori dei Token saranno pagati solo se e dopo che tutte le obbligazioni senior dell'Emittente saranno state estinte.</p>
<b>SEZIONE 4 - INFORMAZIONI CHIAVE SULL'OFFERTA DI TITOLI AL PUBBLICO</b>	
4.1	<b>A quali condizioni e secondo quale calendario posso investire in questo titolo?</b>
<p><b>Paesi in cui vengono offerti i titoli</b> L'offerta consiste in offerte pubbliche in Austria, Belgio, Bulgaria, Croazia, Cipro, Repubblica Ceca, Danimarca, Estonia, Finlandia, Francia, Germania, Grecia, Ungheria, Islanda, Irlanda, Italia, Lettonia, Liechtenstein, Lituania, Lussemburgo, Malta, Paesi Bassi, Norvegia, Polonia, Portogallo, Romania, Slovacchia, Slovenia, Spagna, Svezia e Svizzera, nonché in collocamenti privati in alcune giurisdizioni al di fuori di queste.</p> <p><b>Paesi in cui i titoli non sono offerti</b> I Global Token AWEARE dell'Emittente non sono e non saranno registrati ai sensi delle disposizioni dello United States Securities Act del 1933, e successive modifiche, o presso le autorità di regolamentazione dei titoli di qualsiasi stato degli Stati Uniti d'America, o in Australia, Giappone o Canada. Di conseguenza, non saranno offerti, venduti o consegnati direttamente o indirettamente al pubblico, se non in virtù di un'esenzione dai requisiti di registrazione. In particolare, il presente Prospetto non costituisce o rappresenta un'offerta di vendita o una sollecitazione di un'offerta di acquisto di AWEARE Global Tokens negli Stati Uniti d'America, in Australia, Giappone e Canada e non può essere distribuito in tali paesi. Inoltre, il presente Prospetto non costituisce un'offerta di vendita o una sollecitazione di un'offerta di acquisto di AWEARE Global Tokens in Russia, Iran, Corea del Nord, Bielorussia, Siria o in qualsiasi altro territorio. E non può essere distribuito in tali territori.</p> <p><b>Offerta</b> Il processo di sottoscrizione dei Gettoni AWEARE Global avverrà online sul sito <a href="https://kyc.awearetech.li/">https://kyc.awearetech.li/</a> (il "Cruscotto").</p> <p><b>Periodo di offerta</b> Il periodo durante il quale gli investitori possono presentare le loro offerte di acquisto per i Global Token AWEARE inizierà alla data di approvazione del Prospetto e terminerà un anno dopo (il "Periodo di Offerta"). L'ultimo giorno del Periodo di Offerta, le offerte possono essere effettuate fino alle ore 12:00 (ora del Liechtenstein).</p> <p><b>Prezzo dell'offerta</b> Il prezzo di offerta di un Gettone AWEARE è di <b>USD12,00</b> (il "Prezzo di Offerta").</p> <p>Per incoraggiare l'investimento anticipato, sono disponibili i seguenti sconti:</p> <p>Per gli investimenti compresi tra 10.000 USDC e 49.999,99 USDC, gli investitori riceveranno uno sconto del 10%, rendendo il prezzo per gettone AWEARE pari a 10,80 USD.</p> <p>Per investimenti pari o superiori a 50.000 USDC, gli investitori riceveranno uno sconto del 15%, rendendo il prezzo per ogni gettone AWEARE pari a 10,20 USD.</p> <p><b>Disponibilità degli sconti</b> Gli sconti di cui sopra sono disponibili <b>fino al verificarsi di uno dei seguenti eventi, a seconda di quale dei due si verifichi per primo:</b></p> <ul style="list-style-type: none"> <li>● <b>raggiungere un volume totale di investimenti pari a 5.000.000 USDC</b>, oppure</li> <li>● <b>scadenza di tre mesi dall'inizio dell'offerta.</b></li> </ul>	

**Consegna e liquidazione**

Ogni investitore deve completare il processo di sottoscrizione online sulla Dashboard. I Gettoni Globali AWEARE saranno assegnati off-chain come record nel database dell'Emittente, visibile attraverso la Dashboard, a fronte del pagamento del Prezzo di Offerta. I Gettoni Globali AWEARE saranno assegnati on-chain nello Smart Contract al più tardi entro due mesi dalla fine del Periodo di Offerta. Una volta terminata l'offerta totale di AWEARE Global Tokens (dopo aver raggiunto il capitale di partecipazione target) e l'Emittente ha deciso di finalizzare lo Smart Contract, gli AWEARE Global Tokens saranno consegnati al crypto wallet dell'investitore.

**Diluizione**

Poiché il diritto di sottoscrizione legale di tutti i partecipanti è escluso in caso di aumento di capitale nell'ambito della presente offerta, i partecipanti alla presente offerta non saranno diluiti.

**Totale proventi netti e costi di emissione stimati**

I proventi netti totali dell'offerta di oltre 1.400.000 AWEARE Global Token possono ammontare a circa **15.000.000 di dollari USA** corrispondenti all'attuazione della raccolta di fondi. I costi totali previsti per l'offerta ammontano a circa **USD1.500.000** e saranno addebitati sui proventi.

<b>4.2</b>	<b>Perché viene prodotto questo prospetto?</b>
<b>4.2.1</b>	<p>a) I proventi netti stimati dell'emissione dei titoli saranno utilizzati principalmente per la ricerca e lo sviluppo e la protezione della proprietà intellettuale. Se necessario, potrebbe essere necessario spostare fino al 50% del budget assegnato a un'altra posizione.</p> <ul style="list-style-type: none"> <li>i) 10% Costo dell'aumento</li> <li>ii) 11% Generale e amministrativo</li> <li>iii) 41% Ricerca e sviluppo</li> <li>iv) 17% Legale (protezione della proprietà intellettuale globale)</li> <li>v) 21% Sviluppo bus, vendite e marketing</li> </ul> <p>b) Gli attuali azionisti di AWEARE Technologies Inc. e Global Innovation Partners Limited includono Mahesh Reddy e il Dr. Daniel Hyman. Mahesh Reddy e il Dr. Daniel Hyman sono anche amministratori e azionisti di minoranza dell'Emittente.</p> <p>c) Equanimity AG riceve una commissione di transazione pari al 3% del totale dei pagamenti in criptovalute e fiat maturati. Marcel Füssinger, che è uno degli Amministratori dell'Emittente, è anche Amministratore e proprietario di Equanimity AG.</p> <p>d) <b>Totale proventi netti e costi di emissione stimati</b> I proventi netti totali dell'offerta di oltre 1.400.000 AWEARE Global Token possono ammontare a circa <b>15.000.000 di dollari USA</b> corrispondenti all'attuazione della raccolta di fondi. I costi totali previsti per l'offerta ammontano a circa <b>USD1.500.000</b> e saranno addebitati sui proventi.</p> <p>e) <b>Accordi di sottoscrizione</b> L'offerta non è soggetta a un accordo di sottoscrizione. Non esiste alcun accordo in base al quale un sottoscrittore sia obbligato a sottoscrivere i gettoni invenduti. Pertanto, non vi è alcuna garanzia che l'intera offerta venga collocata.</p>

## IV. NOTA DI SINTESI DEL FOLLETO

Esta nota de síntesis contiene todos los elementos que deben incluirse en un resumen para este tipo de valores y emisor.

<b>SECCIÓN 1 - INTRODUCCIÓN</b>		
<b>1.1</b>	<b>Nombre e ISIN de los valores</b>	Los <b>1.400.000</b> nuevos certificados de participación públicos son certificados de participación al portador sin derecho a voto de AWEARE Global AG. El nombre de estos certificados de participación es " <b>AWEARE Global Tokens</b> ". El ISIN es LI1363014385.
<b>1.2</b>	<b>Identidad y datos de contacto del emisor, incluido su identificador de entidad jurídica (LEI)</b>	<b>AWEARE Global AG</b> (el "Emisor") c/o Revalier Aktiengesellschaft Pradafant 11, 9490 Vaduz, Principado de Teléfono: +423 237 63 47 Correo electrónico: info@awearetech.li El LEI es 391200PTNEZNXGJW1C39

1.3	<b>Autoridad competente</b>	<b>Autoridad del Mercado Financiero (la "FMA")</b> Landstrasse 109, 9490 Vaduz, Principado de Liechtenstein Tel: +423 236 73 73 Fax: +423 236 73 74 Correo electrónico: <a href="mailto:info@fma-li.li">info@fma-li.li</a>												
1.4	<b>Fecha de aprobación del folleto</b>	05/12/2024												
1.5	<b>Advertencias</b>													
1.5.1	<p>a) El resumen debe leerse como una introducción al presente Folleto. Cualquier decisión de invertir en los valores debe basarse en la consideración del Folleto en su conjunto por parte del inversor.</p> <p>b) El inversor podría perder todo o parte del capital invertido.</p> <p>c) Cuando se presente ante un tribunal una demanda relativa a la información contenida en el folleto, el inversor demandante podría, en virtud de la legislación nacional, tener que correr con los gastos de traducción del folleto antes de que se inicie el procedimiento judicial.</p> <p>d) Sólo incurrirán en responsabilidad civil las personas que hayan presentado la nota de síntesis, incluida cualquier traducción de la misma, pero únicamente si la nota de síntesis es engañosa, inexacta o incoherente, leída junto con las demás partes del folleto, o no proporciona, leída junto con las demás partes del folleto, información clave para ayudar a los inversores a la hora de decidir si invierten o no en los valores.</p>													
<b>SECCIÓN 2 - INFORMACIÓN CLAVE SOBRE EL EMISOR</b>														
2.1	<b>¿Quién es el emisor de los valores?</b>													
2.1.1	<b>Información sobre el emisor</b>													
	<p>a) El nombre legal y comercial del Emisor es "AWEARE Global AG". El Emisor es una sociedad anónima constituida en el Principado de Liechtenstein y regida por las leyes del Principado de Liechtenstein. El Emisor tiene su domicilio social en Vaduz, Principado de Liechtenstein y está inscrito en la Oficina de Justicia / Registro Mercantil del Principado de Liechtenstein con el número de registro FL-0002.714.015-4.</p> <p>b) El objetivo del Emisor es desarrollar y monetizar tecnologías de sensores e inteligencia artificial para vehículos autónomos y otras aplicaciones.</p> <p>c) Los principales accionistas del Emisor son:</p> <ul style="list-style-type: none"> <li>• Global Innovation Partners Limited, Islas Vírgenes Británicas, con accionistas mayoritarios: Dr. Daniel Hyman, Mahesh Reddy, Dr. Reginald Tang y Mark Hyman.</li> </ul> <p>d) El Consejo de Administración del Emisor está compuesto por:</p> <ul style="list-style-type: none"> <li>• Dr. Daniel Hyman, Nacionalidad: Estados Unidos, Dirección postal: Long Beach, California, EE.UU.</li> <li>• Mahesh Reddy, Nacionalidad: Estados Unidos, Dirección postal: Irvine, California, EE.UU.</li> <li>• Marcel Füssinger, Nacionalidad: Austria, Dirección postal: 160009, Singapur</li> <li>• Revalier AG representada por Reinhold Wohlwend, Nacionalidad: Liechtenstein, Dirección postal: 9490, Vaduz, Liechtenstein</li> </ul> <p>e) El Auditor es: Lucas Tihanyi, Miembro de la Asociación de Auditores de Liechtenstein y EXPERTsuisse, Industriering 14, 9491 Ruggell, Liechtenstein</p>													
2.2	<b>¿Cuál es la información financiera clave relativa al emisor?</b>													
2.2.1	<p>El Emisor se constituyó el 30/11/2023 mediante inscripción en el registro mercantil del Principado de Liechtenstein. Según la declaración del Consejo de Administración de 25 de octubre de 2023, el Emisor no está sujeto a una auditoría ordinaria ni a una revisión de auditoría. No obstante, los estados financieros anuales a 31 de diciembre de 2023 y los estados financieros provisionales a 15 de julio de 2023 fueron auditados por el Auditor.</p> <p>La siguiente información financiera clave se ha elaborado de conformidad con las disposiciones de la Ley de Liechtenstein sobre Personas y Sociedades ("LPL"), en particular el art. 1024 y ss.</p> <p style="text-align: center;"><b>Cuenta de resultados</b></p> <table border="1" data-bbox="403 1738 1251 1989"> <thead> <tr> <th></th> <th style="text-align: center;">31/12/2023</th> <th style="text-align: center;">15/07/2024</th> </tr> </thead> <tbody> <tr> <td><b>Ingresos totales</b></td> <td style="text-align: center;">USD 0</td> <td style="text-align: center;">USD 0</td> </tr> <tr> <td><b>Resultado de explotación</b></td> <td style="text-align: center;">USD -2'473,03</td> <td style="text-align: center;">USD -30'150.54</td> </tr> <tr> <td><b>Beneficios/pérdidas netos</b></td> <td style="text-align: center;">USD -2'473,03</td> <td style="text-align: center;">USD -30'150.54</td> </tr> </tbody> </table>			31/12/2023	15/07/2024	<b>Ingresos totales</b>	USD 0	USD 0	<b>Resultado de explotación</b>	USD -2'473,03	USD -30'150.54	<b>Beneficios/pérdidas netos</b>	USD -2'473,03	USD -30'150.54
	31/12/2023	15/07/2024												
<b>Ingresos totales</b>	USD 0	USD 0												
<b>Resultado de explotación</b>	USD -2'473,03	USD -30'150.54												
<b>Beneficios/pérdidas netos</b>	USD -2'473,03	USD -30'150.54												

### Balance

	31/12/2023	15/07/2024
<b>Activos totales</b>	50 184,35 DÓLARES	75.244,30 DÓLARES
<b>Total fondos propios</b>	47.526,97 USD	19.849,46 DÓLARES
<b>Deuda financiera neta (deuda a largo plazo más deuda a corto plazo menos tesorería)</b>	USD 0	USD 0

### Estado de tesorería

	31/12/2023	15/07/2024
<b>Flujos de tesorería netos pertinentes de las actividades de explotación</b>	USD 0	USD 0
<b>Flujos de tesorería netos procedentes de actividades de inversión</b>	USD 0	USD 0
<b>Flujos de tesorería netos procedentes de actividades de financiación</b>	USD 0	USD 0

Las perspectivas del Emisor no se han deteriorado significativamente desde la fecha del balance provisional a 15/07/2024. No se han producido cambios significativos en la situación financiera o comercial del Emisor desde la fecha de presentación del balance provisional a 15/07/2024.

### 2.3 ¿Cuáles son los principales riesgos específicos del emisor?

**2.3.1**

**Bajo capital**  
El objetivo del Emisor es la comercialización de la tecnología de AWEARE. El capital social del Emisor está limitado a 50.000,00 USD, siendo el capital mínimo exigido por la legislación de Liechtenstein de 50.000,00 USD. Dado que el Emisor se constituyó el 30/11/2023, no se dispone de datos financieros históricos significativos o cifras clave, aparte de la información financiera histórica mencionada en la sección 2.2.1 de este resumen, para evaluar la situación financiera del Emisor en relación con los últimos años. El Emisor no está sujeto a una auditoría ordinaria y no tiene una revisión de auditoría. El Emisor no ha sido evaluado por una agencia de calificación. Unos fondos propios reducidos representan un mayor riesgo para el inversor, ya que la función de capital de garantía se ve correspondientemente reducida.

**Riesgo de insolvencia**  
En caso de apertura de un procedimiento de insolvencia sobre los activos del Emisor, éste se verá temporal o permanentemente limitado en la enajenación de sus activos, o las enajenaciones de activos del Emisor serán asumidas por un administrador concursal designado judicialmente. Esto puede tener un impacto negativo en la situación financiera y las actividades empresariales del Emisor. Este caso puede producirse incluso si las solicitudes de insolvencia se presentaron incorrectamente. En caso de insolvencia del Emisor, los Participantes son responsables con su capital invertido. El capital invertido debe tratarse como fondos propios y, por lo tanto, está subordinado de forma cualificada.

**Financiación de empresas**  
No existe un capital mínimo a recaudar. No existe una garantía de colocación, sino el riesgo de que las Fichas Globales AWEARE no se suscriban en su totalidad (riesgo de colocación). Si el Emisor no consigue solicitar el volumen de emisión deseado, podrá invertir menos. Existe un riesgo de déficit de capital para el Emisor. Además, se mantendrán los costes de emisión, que son independientes del volumen de capital captado, lo que aumentará el coeficiente de gastos en relación con el capital de inversión total captado. Existe el riesgo de que, en este caso, el Emisor no alcance los objetivos de inversión previstos y no pueda cumplir sus obligaciones en virtud de los AWEARE Global Tokens.

**Gestión, tecnología, dependencia de terceros proveedores de servicios, competencia y plazos de desarrollo.**  
Uno de los puntos fuertes del Emisor es su astuto uso de la última tecnología de radar. Sin embargo, las ventajas técnicas en la industria de la tecnología de la información y las comunicaciones pueden ser de corta duración. En

	<p>consecuencia, el éxito de la emisión dependerá, en parte, de su capacidad para gestionar y ampliar los servicios del Emisor y hacer crecer la base de usuarios de su negocio y, por tanto, generar ingresos en respuesta a la evolución de las tecnologías, las demandas de los usuarios y de terceros proveedores de servicios y las presiones competitivas. El fracaso o los retrasos en este sentido pueden repercutir negativamente en el éxito del Emisor.</p> <p><b>Error humano con los contratos inteligentes</b> El Emisor no asume ninguna responsabilidad ni hace ninguna declaración o garantía en cuanto a la funcionalidad del proyecto del Emisor o de cualquier contrato inteligente que pueda ser programado o utilizado para la liquidación de la oferta de conformidad con el presente Folleto en el sentido más amplio. En consecuencia, los inversores pueden sufrir pérdidas o, en general, enfrentarse a una pérdida total. Sin embargo, en tales escenarios, pueden aplicarse mecanismos legales para proteger a un inversor de la pérdida.</p>	
<b>SECCIÓN 3 - INFORMACIÓN CLAVE SOBRE LOS VALORES</b>		
<b>3.1</b>	<b>¿Cuáles son las principales características de los valores?</b>	
<b>3.1.1</b>	<b>Información sobre los valores</b>	
<b>a)</b>	<b>Descripción del tipo y clase de los valores</b>	Los <b>1.400.000</b> nuevos certificados de participación ofrecidos públicamente por el Emisor son certificados de participación al portador sin derecho a voto, cada uno con un valor nominal de <b>0,01 USD</b> del capital de participación (los <b>"Tokens Globales AWEARE"</b> ), procedentes de una nueva emisión de capital de participación acordada por una Junta General extraordinaria el 18/07/2024. Los titulares de los AWEARE Global Tokens se denominan <b>"Participantes"</b> o <b>"Tokenholders"</b> .
<b>b)</b>	<b>Divisa de la emisión de valores</b>	Dólar estadounidense (" <b>USD</b> " o " <b>\$</b> "). La duración de la Ficha Global AWEARE es ilimitada.
<b>c)</b>	<b>Descripción de los derechos vinculados a los valores</b>	<p><b>Derecho de voto</b> Las Fichas Globales AWEARE son certificados de participación sin derecho a voto y no dan derecho al Participante a votar, convocar y participar en la Junta General del Emisor. Además, las Fichas Globales AWEARE no conceden el derecho a la información, el derecho de inspección y el derecho a presentar una solicitud. Sin embargo, puede presentarse a la Junta General una solicitud por escrito de información o inspección o para el inicio de una auditoría oficial.</p> <p><b>Convocatoria y acuerdos de la Junta General</b> La convocatoria de la Junta General debe notificarse a los participantes, junto con los puntos del orden del día y las propuestas de resolución. Todas las resoluciones de la Junta General deberán ponerse sin demora a disposición de los participantes para su inspección en el domicilio social del emisor. Se informará de ello a los participantes en la convocatoria.</p> <p><b>Derecho a dividendos y participación en el producto de la liquidación</b> Las Fichas Globales AWEARE conllevan plenos derechos a dividendos desde la fecha de su adquisición válida y dan derecho a sus titulares a una parte del producto de la liquidación en proporción a su participación en el capital social. El Emisor no tiene previsto actualmente distribuir dividendos en un futuro próximo. Aunque existe un derecho a dividendos en virtud de los estatutos, no se hacen previsiones sobre futuras distribuciones de dividendos. El emisor tiene la intención de reinvertir los beneficios en el crecimiento y desarrollo de la empresa.</p> <p><b>Forma y titulación</b> Los AWEARE Global Tokens se emitirán como tokens. Los tokens son derechos de valor que se emiten en una base de datos descentralizada (Blockchain) y se transfieren allí. La Blockchain utilizada para este fin es la Blockchain de Ethereum.</p> <p><b>Exclusión de los derechos de suscripción y de participación</b> Hasta que se alcance el capital de participación objetivo de 50.000 USD, quedan excluidos los derechos preferentes con arreglo a los artículos 304d, 304f y 304g PCL, en particular los derechos de suscripción y los derechos de participación de los Participantes.</p> <p><b>Transferibilidad de los títulos</b> La transferencia (como transferencia en sentido estricto, pignoración, herencia) de AWEARE Global Tokens requiere la aprobación del Consejo de Administración del Emisor. Por lo tanto, la transferibilidad está limitada hasta cierto punto. En cualquier caso, la transferencia de las Fichas Globales de AWEARE no está permitida si las tiene una persona en un país en el que no se pueden ofrecer las Fichas Globales de AWEARE. También se considera que se produce una transferencia en el sentido anterior si un Titular de Fichas traslada su lugar de residencia a un país en el que no se pueden ofrecer Fichas Globales de AWEARE.</p>

d)	<b>Prelación relativa de los valores en la estructura de capital del emisor en caso de insolvencia</b>	En caso de insolvencia del Emisor, los Participantes responden con su capital invertido. El capital invertido debe tratarse como fondos propios y, por lo tanto, está subordinado de forma cualificada.
e)	<b>Descripción de la política de dividendos</b>	Hasta la fecha no se han pagado dividendos. El Emisor no realiza previsiones ni estimaciones de beneficios, por lo que no se describe la política de dividendos. Los dividendos, en su caso, se pagarán en USD. El Emisor se reserva el derecho de pagar dividendos también en otra moneda o criptomoneda. Toda resolución de pago de dividendos se adoptará de conformidad con la legislación aplicable y dependerá, entre otras cosas, de los resultados de las operaciones del Emisor, su situación financiera, las restricciones contractuales y las necesidades de capital. En cualquier caso, el 5% del beneficio neto se destinará a las reservas estatutarias hasta alcanzar el importe del 10% del capital social desembolsado.
3.2	<b>¿Dónde se negociarán los valores?</b>	
3.2.1	Los AWEARE Global Tokens no están admitidos a negociación en un mercado regulado. El Emisor se reserva el derecho de solicitar la admisión a cotización en un mercado regulado.	
3.4	<b>¿Cuáles son los principales riesgos específicos de los valores?</b>	
3.4.1	<p><b>Cartera de inversores y riesgo de clave privada</b> El inversor es el único que asume el riesgo de la selección del monedero o la ubicación de la clave privada. Si se utiliza un monedero incompatible o si se pierde la clave privada, el acceso a los AWEARE Global Tokens es normalmente imposible. Las consecuencias, como la pérdida total de la inversión, deben ser asumidas únicamente por el inversor.</p> <p><b>Riesgo de vendibilidad, liquidez y realización</b> No hay certeza de que se desarrolle un mercado líquido para las Fichas Globales AWEARE. Como resultado, las Fichas Globales AWEARE no podrían venderse en un mercado secundario, creando un riesgo de liquidez para el inversor.</p> <p><b>Riesgo de volatilidad</b> Existen riesgos relacionados con la volatilidad del precio de las acciones. Si se vendieran las Fichas Globales AWEARE y se vieran atrapadas en una fuerte fluctuación a la baja del precio, el Tokenholder podría sufrir pérdidas, algunas de las cuales podrían ser sustanciales, como resultado de la venta.</p> <p><b>Pérdida de fichas</b> Las Fichas pueden perderse o volverse inaccesibles, en particular si el Titular de la Ficha pierde la clave privada respectiva para disponer de sus Fichas Globales AWEARE o debido al mal funcionamiento del monedero electrónico en el que están almacenadas las Fichas Globales AWEARE. Esto podría resultar en la pérdida de los Tokens. Es responsabilidad exclusiva de los Titulares de las Fichas almacenar y proteger de forma segura la clave privada que permite el acceso al monedero electrónico. Los tokens pueden resultar inaccesibles también en caso de fallecimiento de un titular de tokens si éste no ha tomado las medidas necesarias para tal caso. Ni el Emisor ni ningún otro organismo o institución podrán restablecer el acceso al monedero del titular de la ficha para sus sucesores. La pérdida de claves privadas podría además reducir la disponibilidad de varias funcionalidades de la OST y de las Fichas Globales AWEARE. En particular, podría ser imposible emitir AWEARE Global Tokens a los suscriptores o hacerlos transferibles, en cuyo caso permanecerían en pausa indefinidamente. Además, puede ser imposible realizar pagos de dividendos. Por último, existe el riesgo de que un atacante pueda acuñar AWEARE Global Tokens para direcciones no contribuyentes, alterar el estado de confirmación, contribuir con cantidades no controladas a la OST o permitir al atacante retirar pagos de dividendos no reclamados.</p> <p>AWEARE Global Tokens son certificados de participación sin derecho a voto y no dan derecho a votar, convocar y participar en la Junta General del Emisor. Además, las Fichas Globales AWEARE no conceden el derecho a la información, el derecho de inspección y el derecho a presentar una solicitud. Por lo tanto, la Junta General del Emisor puede adoptar acuerdos que pueden afectar negativamente a los derechos de los Tokenholders. Los Accionistas no tienen la posibilidad de controlar el uso de los ingresos procedentes de la emisión de las Fichas Globales AWEARE. La transferencia (como transferencia en sentido estricto, pignoración, herencia) de las Fichas Globales AWEARE requiere la aprobación del Consejo de Administración del Emisor. En cualquier caso, la transferencia de las Fichas Globales de AWEARE no está permitida si las tiene una persona en un país en el que no se pueden ofrecer las Fichas Globales de AWEARE. También se considera que se produce una transferencia en el sentido anterior si un Titular de Fichas traslada su lugar de residencia a un país en el que no se pueden ofrecer Fichas Globales de AWEARE. Se excluye el derecho de suscripción legal de los Tokenholders en el caso de un aumento de capital en virtud de esta oferta.</p> <p>Los derechos de los tenedores de fichas a reclamar y recibir dividendos del emisor están subordinados a los derechos de todos los titulares de obligaciones no subordinadas del emisor. En caso de liquidación del Emisor, sólo se pagará a los tenedores de fichas una vez que se hayan liquidado todas las obligaciones preferentes del Emisor.</p>	
<b>SECCIÓN 4 - INFORMACIÓN CLAVE SOBRE LA OFERTA PÚBLICA DE VALORES</b>		



4.1	¿En qué condiciones y plazos puedo invertir en este valor?
	<p><b>Países en los que se ofrecen los valores</b> La oferta consiste en ofertas públicas en Alemania, Austria, Bélgica, Bulgaria, Chipre, Croacia, Dinamarca, Eslovaquia, Eslovenia, España, Estonia, Finlandia, Francia, Grecia, Hungría, Irlanda, Islandia, Italia, Letonia, Liechtenstein, Lituania, Luxemburgo, Malta, Noruega, Países Bajos, Polonia, Portugal, República Checa, Rumanía, Suecia y Suiza, así como en colocaciones privadas en determinadas jurisdicciones fuera de las mismas.</p> <p><b>Países en los que no se ofrecen los valores</b> Las Fichas Globales AWEARE del Emisor no están ni estarán registradas según las disposiciones de la Ley de Valores de los Estados Unidos de 1933, en su versión modificada, ni ante las autoridades reguladoras de valores de ningún estado de los Estados Unidos de América, ni en Australia, Japón o Canadá. Por consiguiente, no se ofrecerán, venderán ni entregarán directa o indirectamente al público, salvo en virtud de una exención de los requisitos de registro. En particular, este Folleto no constituye ni supone una oferta de venta ni la solicitud de una oferta de compra de las Fichas Globales AWEARE en los Estados Unidos de América, Australia, Japón y Canadá, y no podrá distribuirse en dichos países. Además, este Folleto no constituye una oferta de venta o solicitud de una oferta de compra de AWEARE Global Tokens en Rusia, Irán, Corea del Norte, Bielorrusia, Siria o cualquiera de sus territorios. Y no puede ser distribuido allí.</p> <p><b>Pujar</b> El proceso de suscripción de las Fichas Globales AWEARE tendrá lugar en línea en <a href="https://kyc.awearetech.li/">https://kyc.awearetech.li/</a> (el "Tablero").</p> <p><b>Periodo de oferta</b> El periodo durante el cual los inversores pueden presentar sus ofertas de compra de Fichas Globales AWEARE comenzará en la fecha de aprobación del Folleto y finalizará un año después (el "<b>Periodo de Oferta</b>"). El último día del Periodo de Oferta, las ofertas podrán realizarse hasta las 12:00 horas, hora de Liechtenstein.</p> <p><b>Precio de oferta</b> El precio de oferta de una Ficha AWEARE es de <b>12,00 USD</b> (el "<b>Precio de Oferta</b>").</p> <p>Para fomentar la inversión temprana, se ofrecen los siguientes descuentos:</p> <p>Para inversiones entre 10.000 USDC y 49.999,99 USDC, los inversores recibirán un descuento del 10%, por lo que el precio por Token AWEARE será de 10,80 USD.</p> <p>Para inversiones de 50.000 USDC o más, los inversores recibirán un descuento del 15%, por lo que el precio por Token AWEARE será de 10,20 USD.</p> <p><b>Disponibilidad de los descuentos</b> Los descuentos anteriores están disponibles <b>hasta que se produzca una de las siguientes situaciones, lo que ocurra primero:</b></p> <ul style="list-style-type: none"> <li>• <b>alcanzar un volumen total de inversión de 5.000.000 USDC, o</b></li> <li>• <b>vencimiento de tres meses desde el inicio de la oferta.</b></li> </ul> <p><b>Entrega y liquidación</b> Cada inversor debe completar el proceso de suscripción en línea en el Panel de Control. Las Fichas Globales AWEARE se asignarán fuera de la cadena como un registro en la base de datos del Emisor, que puede ser visible a través del Panel de Control, contra el pago del Precio de Oferta. Las Fichas Globales AWEARE se asignarán en la cadena en el Contrato Inteligente a más tardar dos meses después del final del Periodo de Oferta. Una vez finalizada la oferta total de Fichas Globales AWEARE (tras alcanzar el capital de participación objetivo) y cuando el Emisor haya decidido finalizar el Contrato Inteligente, las Fichas Globales AWEARE se entregarán en la criptocartera del inversor.</p> <p><b>Dilución</b> Dado que el derecho de suscripción legal de todos los participantes queda excluido en caso de ampliación de capital en el contexto de esta oferta, los participantes en la misma no se diluirán.</p> <p><b>Total ingresos netos y costes de emisión estimados</b> Los ingresos netos totales de la oferta sobre 1.400.000 Fichas Globales AWEARE pueden ascender a aproximadamente <b>15.000.000 USD</b> correspondientes a la implementación de la recaudación de fondos. Los costes totales previstos de la oferta ascienden a aproximadamente <b>1.500.000 USD</b> y se cargarán a los ingresos.</p>
4.2	¿Por qué se elabora este folleto?
4.2.1	<p>a) Los ingresos netos estimados de la emisión de los títulos se utilizarán principalmente para investigación y desarrollo y protección de la propiedad intelectual. Podría ser necesario desplazar hasta el 50% de un presupuesto asignado a otro puesto en caso necesario.</p> <p style="margin-left: 40px;">i) 10% Coste del aumento</p> <p style="margin-left: 40px;">ii) 11% Gastos generales y administrativos</p> <p style="margin-left: 40px;">iii) 41% Investigación y desarrollo</p> <p style="margin-left: 40px;">iv) 17% Legal (Protección global de la PI)</p>

	<p>v) 21% Desarrollo de negocio, ventas y marketing</p> <p>b) Los actuales accionistas de AWEARE Technologies Inc. y Global Innovation Partners Limited son Mahesh Reddy y el Dr. Daniel Hyman. Mahesh Reddy y el Dr. Daniel Hyman son también directores y accionistas minoritarios del Emisor.</p> <p>c) Equanimity AG recibe una comisión por transacción del 3% del total de criptomonedas y pagos en fiat devengados. Marcel Füssinger, que es uno de los Directores del Emisor, es también Director y propietario de Equanimity AG.</p> <p>d) <b>Total ingresos netos y costes de emisión estimados</b> Los ingresos netos totales de la oferta sobre 1.400.000 Fichas Globales AWEARE pueden ascender a aproximadamente <b>15.000.000 USD</b> correspondientes a la implementación de la recaudación de fondos. Los costes totales previstos de la oferta ascienden a aproximadamente <b>1.500.000 USD</b> y se cargarán a los ingresos.</p> <p>e) <b>Acuerdos de suscripción</b> La oferta no está sujeta a un acuerdo firme de suscripción. No existe ningún acuerdo en virtud del cual un suscriptor esté obligado a suscribir los tokens no vendidos. Por lo tanto, no hay garantía de que se coloque la totalidad de la oferta.</p>
--	---

## V. SAMMANFATTNING AV PROSPEKT

Denna sammanfattning innehåller alla delar som krävs för att ingå i en sammanfattning för denna typ av värdepapper och emittent.

AVSNITT 1 - INLEDNING		
1.1	Värdepapperens namn och ISIN-kod	De 1 400 000 nya deltagandecertifikaten som offentliggörs är innehavarbaserade deltagandecertifikat utan rösträtt i AWEARE Global AG. Namnet på dessa deltagandecertifikat är "AWEARE Global Tokens". ISIN-koden är LI1363014385.
1.2	Identitets- och kontaktuppgifter för emittenten, inklusive dess identifieringskod för juridiska personer (LEI)	<b>AWEARE Global AG ("Emittenten")</b> c/o Revalier Aktiengesellschaft Pradafant 11, 9490 Vaduz, Furstendömet Tel: +423 237 63 47 E-post: <a href="mailto:info@awearetech.li">info@awearetech.li</a> LEI är: 391200PTNEZNXGJW1C39
1.3	Behörig myndighet	<b>Finansmarknadsinspektionen ("FMA")</b> Landstrasse 109, 9490 Vaduz, Furstendömet Liechtenstein Tel: +423 236 73 73 Fax: +423 236 73 74 E-post: <a href="mailto:info@fma.li">info@fma.li</a>
1.4	Datum för godkännande av prospektet	05/12/2024
1.5	Varningar	
1.5.1	<p>a) Sammanfattningen bör läsas som en introduktion till detta prospekt. Varje beslut om att investera i värdepapperen ska baseras på en bedömning av Prospektet i dess helhet från investerarens sida.</p> <p>b) Investeraren kan förlora hela eller delar av det investerade kapitalet.</p> <p>c) Om talan väcks vid domstol med anledning av information i prospektet kan den investerare som är kärande enligt nationell rätt bli tvungen att svara för kostnaderna för översättning av prospektet innan de rättsliga förfarandena inleds.</p> <p>d) Civilrättsligt ansvar ska endast åläggas de personer som har lagt fram sammanfattningen inklusive eventuella översättningar därav, men endast om sammanfattningen är vilseledande, felaktig eller oförenlig med de andra delarna av prospektet eller om den inte, tillsammans med de andra delarna av prospektet, ger nyckelinformation för att hjälpa investerare när de överväger att investera i värdepapperen.</p>	
AVSNITT 2 - NYCKELINFORMATION OM EMITTENTEN		
2.1	Vem är emittent av värdepapperen?	

2.1.1	<p><b>Information om emittenten</b></p> <p>a) Emittentens juridiska och kommersiella namn är "AWEARE Global AG". Emittenten är ett publikt aktieföretag som är registrerat i Furstendömet Liechtenstein och styrs av lagarna i Furstendömet Liechtenstein. Emittenten har sitt säte i Vaduz, Furstendömet Liechtenstein och är registrerat hos justitiekontoret/handelsregistret i Furstendömet Liechtenstein under registreringsnummer FL-0002.714.015-4.</p> <p>b) Emittentens syfte är att utveckla och tjäna pengar på sensorteknik och artificiell intelligens för autonoma fordon och andra tillämpningar.</p> <p>c) Emittentens största aktieägare är:</p> <ul style="list-style-type: none"> <li>• Global Innovation Partners Limited, Brittiska Jungfruöarna, med majoritetsaktieägarna Dr. Daniel Hyman, Mahesh Reddy, Dr. Reginald Tang och Mark Hyman</li> </ul> <p>d) Emittentens styrelse består av följande personer:</p> <ul style="list-style-type: none"> <li>• Dr. Daniel Hyman, Nationalitet: Förenta staterna, postadress: Long Beach, Kalifornien, USA</li> <li>• Mahesh Reddy, Nationalitet: Förenta staterna, postadress: Irvine, Kalifornien, USA</li> <li>• Marcel Füssinger, Nationalitet: Österrike, Postadress: 160009, Singapore</li> <li>• Revalier AG företräds av Reinhold Wohlwend, nationalitet Liechtenstein, postadress 9490, Vaduz, Liechtenstein</li> </ul> <p>e) Revisorn är: Lucas Tihanyi, medlem av Liechtensteins revisorssammanslutning och EXPERTsuisse, Industriering 14, 9491 Ruggell, Liechtenstein</p>																																				
2.2	<p><b>Vilken är den viktigaste finansiella informationen om emittenten?</b></p> <p>Emittenten grundades den 30/11/2023 genom registrering i handelsregistret i Furstendömet Liechtenstein. Enligt styrelsens uttalande daterat den 25 oktober 2023 är Emittenten inte föremål för en ordinarie revision och är inte föremål för en revisionsgranskning. Årsbokslutet per den 31 december 2023 och delårsbokslutet per den 15 juli 2023 har dock reviderats av Revisorn.</p> <p>Följande finansiella nyckeltal har upprättats i enlighet med bestämmelserna i Liechtensteins person- och aktieföretagslag ("PCL"), i synnerhet art. 1024 och följande.</p> <p style="text-align: center;"><b>Resultaträkning</b></p> <table border="1" style="margin-left: auto; margin-right: auto;"> <thead> <tr> <th></th> <th style="text-align: center;">31/12/2023</th> <th style="text-align: center;">15/07/2024</th> </tr> </thead> <tbody> <tr> <td><b>Totala intäkter</b></td> <td style="text-align: center;">USD 0</td> <td style="text-align: center;">USD 0</td> </tr> <tr> <td><b>Rörelsevinst/-förlust</b></td> <td style="text-align: center;">USD -2'473,03</td> <td style="text-align: center;">USD -30'150,54</td> </tr> <tr> <td><b>Nettovinst/förlust</b></td> <td style="text-align: center;">USD -2'473,03</td> <td style="text-align: center;">USD -30'150,54</td> </tr> </tbody> </table> <p style="text-align: center;"><b>Balansräkning</b></p> <table border="1" style="margin-left: auto; margin-right: auto;"> <thead> <tr> <th></th> <th style="text-align: center;">31/12/2023</th> <th style="text-align: center;">15/07/2024</th> </tr> </thead> <tbody> <tr> <td><b>Summa tillgångar</b></td> <td style="text-align: center;">50'184,35 USD</td> <td style="text-align: center;">75'244,30 USD</td> </tr> <tr> <td><b>Summa eget kapital</b></td> <td style="text-align: center;">47.526,97 USD</td> <td style="text-align: center;">USD 19'849,46</td> </tr> <tr> <td><b>Finansiell nettoskuld (långfristig skuld plus kortfristig skuld minus kassa)</b></td> <td style="text-align: center;">USD 0</td> <td style="text-align: center;">USD 0</td> </tr> </tbody> </table> <p style="text-align: center;"><b>Kassaflödesanalys</b></p> <table border="1" style="margin-left: auto; margin-right: auto;"> <thead> <tr> <th></th> <th style="text-align: center;">31/12/2023</th> <th style="text-align: center;">15/07/2024</th> </tr> </thead> <tbody> <tr> <td><b>Relevant nettokassaflöde från den löpande verksamheten</b></td> <td style="text-align: center;">USD 0</td> <td style="text-align: center;">USD 0</td> </tr> <tr> <td><b>Relevant netto Kassaflöde från investeringsverksamheten</b></td> <td style="text-align: center;">USD 0</td> <td style="text-align: center;">USD 0</td> </tr> <tr> <td><b>Relevant netto Kassaflöde från finansieringsverksamheten</b></td> <td style="text-align: center;">USD 0</td> <td style="text-align: center;">USD 0</td> </tr> </tbody> </table>		31/12/2023	15/07/2024	<b>Totala intäkter</b>	USD 0	USD 0	<b>Rörelsevinst/-förlust</b>	USD -2'473,03	USD -30'150,54	<b>Nettovinst/förlust</b>	USD -2'473,03	USD -30'150,54		31/12/2023	15/07/2024	<b>Summa tillgångar</b>	50'184,35 USD	75'244,30 USD	<b>Summa eget kapital</b>	47.526,97 USD	USD 19'849,46	<b>Finansiell nettoskuld (långfristig skuld plus kortfristig skuld minus kassa)</b>	USD 0	USD 0		31/12/2023	15/07/2024	<b>Relevant nettokassaflöde från den löpande verksamheten</b>	USD 0	USD 0	<b>Relevant netto Kassaflöde från investeringsverksamheten</b>	USD 0	USD 0	<b>Relevant netto Kassaflöde från finansieringsverksamheten</b>	USD 0	USD 0
	31/12/2023	15/07/2024																																			
<b>Totala intäkter</b>	USD 0	USD 0																																			
<b>Rörelsevinst/-förlust</b>	USD -2'473,03	USD -30'150,54																																			
<b>Nettovinst/förlust</b>	USD -2'473,03	USD -30'150,54																																			
	31/12/2023	15/07/2024																																			
<b>Summa tillgångar</b>	50'184,35 USD	75'244,30 USD																																			
<b>Summa eget kapital</b>	47.526,97 USD	USD 19'849,46																																			
<b>Finansiell nettoskuld (långfristig skuld plus kortfristig skuld minus kassa)</b>	USD 0	USD 0																																			
	31/12/2023	15/07/2024																																			
<b>Relevant nettokassaflöde från den löpande verksamheten</b>	USD 0	USD 0																																			
<b>Relevant netto Kassaflöde från investeringsverksamheten</b>	USD 0	USD 0																																			
<b>Relevant netto Kassaflöde från finansieringsverksamheten</b>	USD 0	USD 0																																			

	Emittentens framtidsutsikter har inte försämrats väsentligt sedan delårsbokslutet per den 15/07/2024. Det har inte skett några väsentliga förändringar i Emittentens finansiella ställning eller handelsposition sedan rapporteringsdatumet för delårsbalansräkningen per den 15/07/2024.	
<b>2.3</b>	<b>Vilka är de viktigaste riskerna som är specifika för emittenten?</b>	
<b>2.3.1</b>	<p><b>Lågt kapital</b> Emittentens syfte är kommersialisering av AWEAREs teknologi. Emittentens aktiekapital är begränsat till 50 000,00 USD, där det minimikapital som krävs enligt Liechtensteins lag är 50 000,00 USD. Eftersom Emittenten bildades den 30/11/2023 finns inga väsentliga historiska finansiella data eller nyckeltal, utöver den historiska finansiella information som avses i avsnitt 2.2.1 i denna sammanfattning, tillgängliga för att bedöma Emittentens finansiella situation i förhållande till de senaste åren. Emittenten är inte föremål för en ordinarie revision och har inte en revisionsgranskning. Emittenten har inte utvärderats av något kreditvärderingsinstitut. Lågt eget kapital innebär en ökad risk för investeraren, eftersom funktionen som ansvarigt kapital minskar i motsvarande grad.</p> <p><b>Insolvensrisk</b> I händelse av att ett insolvensförfarande inleds avseende Emittentens tillgångar, kommer Emittenten tillfälligt eller permanent att vara begränsad i avyttringen av sina tillgångar, eller så kommer avyttringen av Emittentens tillgångar att tas över av en av domstol utsedd insolvensförvaltare. Detta kan ha en negativ inverkan på Emittentens finansiella ställning och affärsverksamhet. Detta fall kan inträffa även om insolvensansökan har lämnats in på ett felaktigt sätt. I händelse av Emittentens insolvens är Deltagarna ansvariga med sitt investerade kapital. Det investerade kapitalet ska behandlas som eget kapital och är därför kvalificerat efterställt.</p> <p><b>Finansiering av företag</b> Det finns inget minimikapital som ska anskaffas. Det finns ingen placeringsgaranti, utan snarare en risk för att AWEARE Global Tokens inte blir fulltecknade (placersingsrisk). Om Emittenten inte lyckas få in den önskade emissionsvolymen kommer Emittenten att kunna investera mindre. Det finns en risk för kapitalbrist för Emittenten. Dessutom kommer emissionskostnaderna, som är oberoende av hur mycket kapital som anskaffas, att kvarstå, vilket kommer att öka omkostnadsprocenten i förhållande till det totala investeringskapital som anskaffas. Det finns en risk att Emittenten i detta fall inte kommer att uppnå sina avsedda investeringsmål och inte kommer att kunna fullgöra sina skyldigheter enligt AWEARE Global Tokens.</p> <p><b>Ledning, teknik, beroende av tredjepartsleverantörer, konkurrens och utvecklingstider</b> En av emittentens viktigaste styrkor är dess skickliga användning av den senaste radartekniken. Tekniska fördelar inom informations- och kommunikationsteknikbranschen kan dock vara kortlivade. Följaktligen kommer emissionens framgång delvis att bero på dess förmåga att hantera och utöka emittentens tjänster och öka dess verksamhets användbarhet och därmed generera intäkter som svar på förändrad teknik, användares och tredjepartsleverantörers krav och konkurrenstryck. Misslyckande eller förseningar i detta kan ha en negativ inverkan på Emittentens framgång.</p> <p><b>Mänskliga fel med smarta kontrakt</b> Emittenten tar inget ansvar och gör inga utfästelser eller garantier avseende funktionaliteten i Emittentens projekt eller i några smarta kontrakt som kan programmeras eller användas för avveckling av erbjudandet i enlighet med detta Prospekt i dess vidaste bemärkelse. Investerare kan drabbas av värdeminskningar till följd av detta eller i allmänhet stå inför en totalförlust. I sådana scenarier kan dock rättsliga mekanismer tillämpas för att skydda en investerare från förlust.</p>	
<b>AVSNITT 3 - NYCKELINFORMATION OM VÄRDEPAPPEREN</b>		
<b>3.1</b>	<b>Vilka är de viktigaste egenskaperna hos värdepapperen?</b>	
<b>3.1.1</b>	<b>Information om värdepapperen</b>	
<b>a)</b>	<b>Beskrivning av värdepapperens typ och klass</b>	De <b>1 400 000</b> nya deltagarbevis som erbjuds offentligt av Emittenten är innehavarbevis utan rösträtt, var och en med ett nominellt värde om <b>0,01 USD</b> av deltagarkapitalet (" <b>AWEARE Global Tokens</b> "), från en nyemission av deltagarkapital som beslutades av en extra bolagsstämma den 18/07/2024. Innehavare av AWEARE Global Tokens kallas " <b>Deltagare</b> " eller " <b>Tokeninnehavare</b> ".
<b>b)</b>	<b>Valuta för värdepappersemissionen</b>	Amerikanska dollar (" <b>USD</b> " eller " <b>\$</b> "). Löptiden för AWEARE Global Token är obegränsad.
<b>c)</b>	<b>Beskrivning av de rättigheter som är förenade med värdepapperen</b>	<b>Rösträtt</b> AWEARE Global Tokens är icke-röstberättigade deltagarcertifikat och berättigar inte Deltagaren att rösta på, sammankalla och delta i Emittentens bolagsstämma. Vidare ger AWEARE Global Tokens inte rätt till information, rätt till inspektion eller rätt att göra en ansökan. En skriftlig begäran om information eller inspektion eller om inledande av en officiell revision kan dock lämnas in till bolagsstämman.

		<p><b>Meddelande om kallelse till och beslut vid bolagsstämma</b> Deltagarna ska underrättas om kallelse till bolagsstämma samt om ärenden på dagordningen och förslagen. Varje beslut av bolagsstämman måste utan dröjsmål göras tillgängligt för inspektion av deltagarna på emittentens säte. Deltagarna skall informeras om detta i kallelsen.</p> <p><b>Rätt till utdelning och andel av likvidationslikvid</b> AWEARE Global Tokens har full utdelningsrätt från dagen för giltigt förvärv och berättigar innehavarna till en andel av likvidationsintäkterna i proportion till deras deltagande i deltagarkapitalet. Emittenten planerar för närvarande inte att dela ut utdelningar inom en snar framtid. Även om ett krav på utdelning finns enligt bolagsordningen, görs inga prognoser avseende framtida utdelningar. Emittenten avser att återinvestera vinster i den fortsatta tillväxten och utvecklingen av företaget.</p> <p><b>Form och värdepapperisering</b> AWEARE Global Tokens kommer att utfärdas som tokens. Tokens är värderättigheter som utfärdas på en decentraliserad databas (Blockchain) och överförs dit. Den Blockchain som används för detta ändamål är Ethereum Blockchain.</p> <p><b>Uteslutande av teckningsrätter och vinstandelsrätter</b> Fram till dess att målet om ett deltagandekapital om 50 000 USD har uppnåtts, är företrädesrätterna enligt artiklarna 304d, 304f och 304g i PCL, i synnerhet deltagarnas teckningsrätter och deltaganderätter, uteslutna.</p> <p><b>Värdepapperens överlåtbarhet</b> Överlåtelse (såsom överlåtelse i snäv bemärkelse, pantsättning, arv) av AWEARE Global Tokens kräver godkännande av Emittentens styrelse. Överlåtbarheten är därför begränsad i viss utsträckning. I vart fall är en överlåtelse av AWEARE Global Tokens inte tillåten om de då skulle komma att innehas av en person i ett land där AWEARE Global Tokens inte får erbjudas. En överföring i ovanstående mening anses också ske om en Tokeninnehavare flyttar sin bostadsort till ett land där AWEARE Global Tokens inte får erbjudas.</p>
d)	<b>Värdepapperens relativa företräde i emittentens kapitalstruktur i händelse av insolvens</b>	I händelse av emittentens insolvens är deltagarna ansvariga med sitt investerade kapital. Det investerade kapitalet ska behandlas som eget kapital och är därför kvalificerat efterställt.
e)	<b>Beskrivning av utdelningspolicy</b>	Ingen utdelning har betalats hittills. Emittenten gör inte några vinstprognoser eller uppskattningar och därför görs ingen beskrivning av utdelningspolicy. Eventuella utdelningar kommer att betalas i USD. Emittenten förbehåller sig rätten att betala utdelning även i en annan valuta eller kryptovaluta. Varje beslut om att betala utdelning kommer att fattas i enlighet med tillämplig lag och kommer bland annat att bero på Emittentens resultat, finansiella ställning, avtalsmässiga begränsningar och kapitalkrav. I vilket fall som helst kommer 5% av nettovinsten att avsättas till de lagstadgade reserverna tills dessa har nått ett belopp motsvarande 10% av det inbetalda aktiekapitalet.
<b>3.2</b>	<b>Var kommer värdepapperen att handlas?</b>	
<b>3.2.1</b>	AWEARE Global Tokens är inte upptagna till handel på en reglerad marknad. Emittenten förbehåller sig rätten att ansöka om upptagande till handel på en reglerad marknad.	
<b>3.4</b>	<b>Vilka är de viktigaste riskerna som är specifika för värdepapperen?</b>	
<b>3.4.1</b>	<p><b>Risk för investerarens plånbok och privata nycklar</b> Investeraren bär ensam risken för valet av plånbok eller placeringen av den privata nyckeln. Om en inkompatibel plånbok används eller om den privata nyckeln förloras, är det normalt omöjligt att få tillgång till AWEARE Global Tokens. Konsekvenserna, såsom total förlust av investeringen, måste bäras enbart av investeraren.</p> <p><b>Försäljningsrisk, likviditetsrisk och realisationsrisk</b> Det finns ingen säkerhet för att en likvid marknad kommer att utvecklas för AWEARE Global Tokens. Som ett resultat av detta kan AWEARE Global Tokens inte säljas på en sekundärmarknad, vilket skapar likviditetsrisk för investeraren.</p> <p><b>Volatilitetsrisk</b> Det finns risker i samband med volatiliteten i aktiekursen. Om AWEARE Global Tokens skulle säljas och de fångas i en kraftig nedåtgående prisfluktuation, kan Tokeninnehavaren drabbas av förluster, varav vissa kan vara betydande, till följd av försäljningen.</p> <p><b>Förlust av polletter</b></p>	

Tokens kan gå förlorade eller bli oåtkomliga, i synnerhet om Tokeninnehavaren förlorar respektive privat nyckel för att avyttra sina AWEARE Global Tokens eller på grund av funktionsfel i den e-plånbok där AWEARE Global Tokens lagras. Detta kan resultera i förlust av Tokens. Det är Tokeninnehavarens enda ansvar att säkert förvara och skydda den privata nyckeln som ger tillgång till e-plånboken. Tokens kan bli otillgängliga även i händelse av en Tokeninnehavares död om han eller hon inte har vidtagit åtgärder för sådana fall. Varken Emittenten eller något annat organ eller institution kommer att kunna återställa tillgången till Tokeninnehavarens plånbok för Tokeninnehavarens efterträdare. Förlusten av privata nycklar kan dessutom minska tillgängligheten av olika funktioner i STO och AWEARE Global Tokens. I synnerhet kan det vara omöjligt att utfärda AWEARE Global Tokens till abonnenter eller att göra dem överförbara, i vilket fall de skulle förbli pausade på obestämd tid. Vidare kan det vara omöjligt att göra utdelningsbetalningar. Slutligen finns det en risk för att en angripare kan prägla AWEARE Global Tokens för icke-bidragsgivande adresser, ändra bekräftelsestatus, bidra med okontrollerade belopp till STO eller tillåta angriparen att ta ut obehöriga utdelningar.

#### **Begränsade rättigheter för Tokeninnehavare**

AWEARE Global Tokens är icke-röstberättigade deltagarcertifikat och ger inte Tokeninnehavarna rätt att rösta på, sammankalla och delta i Emittentens bolagsstämma. Vidare ger AWEARE Global Tokens inte rätt till information, rätt till inspektion eller rätt att göra en ansökan. Emittentens bolagsstämma kan därför anta beslut som kan ha en negativ inverkan på Tokeninnehavarnas rättigheter. Tokeninnehavare har ingen möjlighet att kontrollera användningen av intäkterna från emissionen av AWEARE Global Tokens. Överlåtelse (såsom överlåtelse i snäv bemärkelse, pantsättning, arv) av AWEARE Global Tokens kräver godkännande av Emittentens styrelse. Under alla omständigheter är en överföring av AWEARE Global Tokens inte tillåten om de då skulle innehåsa av en person i ett land där AWEARE Global Tokens inte får erbjudas. En överföring i ovanstående mening anses också ske om en Tokeninnehavare flyttar sin bostadsort till ett land där AWEARE Global Tokens inte får erbjudas. Den lagstadgade teckningsrätten för Tokeninnehavarna i händelse av en kapitalökning enligt detta erbjudande är utesluten.

#### **Tokeninnehavarnas fordringar är underordnade**

Tokeninnehavarnas rätt att kräva och erhålla utdelningar från Emittenten är underordnad fordringarna från alla innehavare av icke efterställda förpliktelser från Emittenten. Vid en likvidation av Emittenten kommer Tokeninnehavare endast att betalas om och efter att alla Emittentens seniora skyldigheter har fullgjorts.

## **AVSNITT 4 - NYCKELINFORMATION OM ERBJUDANDE AV VÄRDEPAPPER TILL ALLMÄNHETEN**

### **4.1 På vilka villkor och enligt vilken tidtabell kan jag investera i detta värdepapper?**

#### **Länder där värdepapperen erbjuds**

Erbjudandet består av offentliga erbjudanden i Belgien, Bulgarien, Cypern, Danmark, Estland, Finland, Frankrike, Grekland, Irland, Island, Italien, Kroatien, Lettland, Liechtenstein, Litauen, Luxemburg, Malta, Nederländerna, Norge, Polen, Portugal, Rumänien, Schweiz, Slovakien, Slovenien, Spanien, Sverige, Tjeckien, Tyskland, Ungern och Österrike samt privata placeringar i vissa jurisdiktioner utanför dessa.

#### **Länder där värdepapperen inte erbjuds**

Emittentens AWEARE Global Tokens är inte och kommer inte att registreras enligt bestämmelserna i United States Securities Act från 1933, i dess nuvarande lydelse, eller hos värdepappersmyndigheterna i någon delstat i USA, eller i Australien, Japan eller Kanada. Följaktligen kommer de inte att erbjudas, säljas eller levereras direkt eller indirekt till allmänheten, förutom i enlighet med ett undantag från registreringskraven. I synnerhet utgör inte detta Prospekt ett erbjudande att sälja eller en uppmaning till ett erbjudande att köpa AWEARE Global Tokens i USA, Australien, Japan eller Kanada och får inte distribueras där. Därutöver utgör detta Prospekt inte ett erbjudande att sälja eller en uppmaning att lämna ett erbjudande att köpa AWEARE Global Tokens i Ryssland, Iran, Nordkorea, Vitryssland, Syrien eller något av dess territorier. Och får inte distribueras däri.

#### **Budgivning**

Teckningsprocessen för AWEARE Global Tokens kommer att ske online på <https://kyc.awaretech.li/> ("Dashboarden").

#### **Erbjudandeperiod**

Den period under vilken investerare kan lämna sina erbjudanden om köp av AWEARE Global Tokens ska inledas på dagen för godkännandet av Prospektet och avslutas ett år senare ("Erbjudandeperioden"). På den sista dagen i Erbjudandeperioden kan erbjudanden lämnas fram till kl. 12.00 Liechtenstein-tid.

#### **Anbudspris**

Budpriset för en AWEARE Token är **12,00 USD** ("Budpriset").

För att uppmuntra tidiga investeringar finns följande rabatter tillgängliga:

För investeringar mellan 10 000 USDC och 49 999,99 USDC erhåller investerare en rabatt om 10%, vilket innebär att priset per AWEARE Token blir 10,80 USD.

För investeringar på 50 000 USDC eller mer kommer investerare att få en rabatt på 15%, vilket gör priset per AWEARE Token 10,20 USD.

#### **Tillgänglighet för rabatter**

Ovanstående rabatter är tillgängliga tills något av följande inträffar, beroende på vilket som inträffar först:

- **oppnår en total investeringsvolym om 5.000.000 USDC**, eller
- **utgången av tre måneder från erbjudandets start.**

#### Leverans och avrækning

Varje investerare måste slutföra online-teckningsprosessen på Instrumentpanelen. AWEARE Global Tokens kommer att tilldelas utanför kedjan som en post i emittentens databas, som kan ses via instrumentpanelen, mot betaling av budpriset. AWEARE Global Tokens kommer att allokeras on-chain i Smart Contract senast inom två måneder efter utgången av Erbjudandeperioden. Når det totala erbjudandet av AWEARE Global Tokens (efter att ha nått målet for deltagarkapital) har avslutats och emittenten har besluttat att slutföra det smarta kontraktet, kommer AWEARE Global Tokens att levereras till investerarens kryptoplånbok.

#### Utspækning

Eftersom den lagstaddede teckningsrækten for samtlige Deltagere er utesluten i hændelse av en kapitaløkning inom ramen for dette erbjudande, kommer Deltagarna i dette erbjudande inte att spækas ut.

#### Total nettoliekvid og beræknde emissionskostnader

Den totala nettoliekviden från erbjudandet över 1 400 000 AWEARE Global Tokens kan komma att uppgå till cirka **15 000 000 USD** motsvarande genomförandet av kapitalanskaffningen. De förväntade totala kostnaderna for erbjudandet uppgår till cirka **1 500 000 USD** og kommer att belasta emissionsliekviden.

<b>4.2</b>	<b>Varför opprættes dette prospekt?</b>
<b>4.2.1</b>	<p>a) Den beræknde nettoliekviden från emissionen av værdpapieren kommer fræmst att anvædas for forskning og utveckling samt immaterialrættsligt skydd. Det kan bli nødvændigt att flytta opp till 50% av en tilldelad budget till en annan position om så krævs.</p> <ul style="list-style-type: none"> <li>i) 10% Kostnad for højing</li> <li>ii) 11% Allmænt og administrativt</li> <li>iii) 41% Forskning &amp; utveckling</li> <li>iv) 17% Juridik (globalt skydd av immaterielle rættigheter)</li> <li>v) 21% Bus Dev, førsæljning og marknadsføring</li> </ul> <p>b) De nuvarande aktieægarna i AWEARE Technologies Inc. og Global Innovation Partners Limited inkluderer Mahesh Reddy og Dr. Daniel Hyman. Mahesh Reddy og Dr. Daniel Hyman er ogskå styrelseledamøter og minoritetsaktieægare i Emittenten.</p> <p>c) Equanimity AG erhåller en transaktionsavgift på 3% av de totala kryptovalutorna og fiatbetalingarna som oppkommit. Marcel Füssinger, som er en av styrelseledamøterne i emittenten, er ogskå styrelseledamot og ægare av Equanimity AG.</p> <p>d) <b>Total nettoliekvid og beræknde emissionskostnader</b> Den totala nettoliekviden från erbjudandet over 1 400 000 AWEARE Global Tokens kan komme att uppgå till cirka <b>15 000 000 USD</b> motsvarande gennemførandet av kapitalanskaffningen. De føvæntede totala kostnaderna for erbjudandet uppgår till cirka <b>1 500 000 USD</b> og kommer att debiteras från intækterne.</p> <p>e) <b>Førsækringsarrangemang</b> Erbjudandet er ikke føværemål for ett bindande garantiavtal. Det finns inget avtal enligt vilket en emissionsgarant er skyldig att teckna osålda tokens. Det finns dærfør ingen garanti for att hela erbjudandet kommer att placeras.</p>

## VI. RESUMÉ AF PROSPEKTET

Dette resumé indeholder alle de elementer, der skal indgå i et resumé for denne type værdipapirer og udsteder.

AFSNIT 1 - INTRODUKTION		
<b>1.1</b>	<b>Værdipapirernes navn og ISIN-kode</b>	De <b>1.400.000</b> nye deltagelsescertifikater, der offentliggøres, er ikke-stemmeberettigede ihændehaverdeltagelsescertifikater fra AWEARE Global AG. Navnet på disse deltagelsesbeviser er " <b>AWEARE Global Tokens</b> ". ISIN er LI1363014385.

1.2	<b>Udstederens identitet og kontaktoplysninger, herunder identifikation af den juridiske enhed (LEI)</b>	<b>AWEARE Global AG ("Udsteder")</b> c/o Revalier Aktiengesellschaft Pradafant 11, 9490 Vaduz, Fyrstendømmet Tlf: +423 237 63 47 E-mail: <a href="mailto:info@awearetech.li">info@awearetech.li</a> LEI-nummeret er: 391200PTNEZNXGJW1C39						
1.3	<b>Kompetent myndighed</b>	<b>Myndigheden for det finansielle marked ("FMA")</b> Landstrasse 109, 9490 Vaduz, Fyrstendømmet Liechtenstein Tlf: +423 236 73 73 Fax: +423 236 73 74 E-mail: <a href="mailto:info@fma-li.li">info@fma-li.li</a>						
1.4	<b>Dato for godkendelse af prospektet</b>	05/12/2024						
1.5	<b>Advarsler</b>							
1.5.1	<p>a) Resuméet skal læses som en introduktion til dette prospekt. Enhver beslutning om at investere i værdipapirerne bør være baseret på investorens overvejelse af prospektet som helhed.</p> <p>b) Investoren kan miste hele eller dele af den investerede kapital.</p> <p>c) Hvis et krav vedrørende oplysninger i prospektet indbringes for en domstol, kan den sagsøgende investor i henhold til national lovgivning være nødt til at afholde omkostningerne til oversættelse af prospektet, før retssagen indledes.</p> <p>d) Civilretligt ansvar påhviler kun de personer, der har fremlagt resuméet, herunder enhver oversættelse heraf, men kun hvis resuméet er vildledende, unøjagtigt eller uoverensstemmende, når det læses sammen med de øvrige dele af prospektet, eller hvis det ikke, når det læses sammen med de øvrige dele af prospektet, giver nøgleoplysninger for at hjælpe investorer med at overveje, om de vil investere i værdipapirerne.</p>							
<b>AFSNIT 2 - NØGLEOPLYSNINGER OM UDSTEDER</b>								
2.1	<b>Hvem er udsteder af værdipapirerne?</b>							
2.1.1	<b>Oplysninger om udsteder</b>							
	<p>a) Udsteders juridiske og kommercielle navn er "AWEARE Global AG". Udstederen er et aktieselskab, der er stiftet i Fyrstendømmet Liechtenstein og underlagt lovgivningen i Fyrstendømmet Liechtenstein. Udsteder har sit hjemsted i Vaduz, Fyrstendømmet Liechtenstein, og er registreret hos justitsministeriet/handelsregistret i Fyrstendømmet Liechtenstein under registreringsnummer FL-0002.714.015-4.</p> <p>b) Udstederens formål er at udvikle og tjene penge på sensorteknologier og kunstig intelligens til selvkørende køretøjer og andre anvendelser.</p> <p>c) Udstederens hovedaktionærer er:</p> <ul style="list-style-type: none"> <li>• Global Innovation Partners Limited, De Britiske Jomfruer med majoritetsaktionærerne Dr. Daniel Hyman, Mahesh Reddy, Dr. Reginald Tang og Mark Hyman.</li> </ul> <p>d) Udstederens bestyrelse består af:</p> <ul style="list-style-type: none"> <li>• Dr. Daniel Hyman, Nationalitet: USA, Postadresse: Long Beach, Californien, USA</li> <li>• Mahesh Reddy, Nationalitet: USA, Postadresse: Irvine, Californien, USA</li> <li>• Marcel Füssinger, Nationalitet: Østrig, Postadresse: 160009, Singapore</li> <li>• Revalier AG repræsenteret ved Reinhold Wohlwend, nationalitet: Liechtenstein, postadresse: 9490, Vaduz, Liechtenstein</li> </ul> <p>e) Revisoren er: Lucas Tihanyi, medlem af Liechtensteins revisorforening og EXPERTsuisse, Industriering 14, 9491 Ruggell, Liechtenstein.</p>							
2.2	<b>Hvad er de vigtigste finansielle oplysninger om udsteder?</b>							
2.2.1	<p>Udstederen blev stiftet den 30/11/2023 ved indførelse i handelsregistret i Fyrstendømmet Liechtenstein. I henhold til bestyrelsens erklæring af 25. oktober 2023 er udstederen ikke underlagt en ordinær revision og er ikke underlagt en revisionsgennemgang. Årsregnskabet pr. 31. december 2023 og delårsregnskabet pr. 15. juli 2023 blev dog revideret af revisoren.</p> <p>Følgende finansielle nøgletal er udarbejdet i overensstemmelse med bestemmelserne i Liechtensteins person- og selskabslov ("PCL"), især art. 1024 ff.</p> <p style="text-align: center;"><b>Resultatopgørelse</b></p> <table border="1" style="margin-left: auto; margin-right: auto;"> <thead> <tr> <th></th> <th style="text-align: center;">31/12/2023</th> <th style="text-align: center;">15/07/2024</th> </tr> </thead> <tbody> <tr> <td style="text-align: center;"><b>Samlet omsætning</b></td> <td style="text-align: center;">USD 0</td> <td style="text-align: center;">USD 0</td> </tr> </tbody> </table>			31/12/2023	15/07/2024	<b>Samlet omsætning</b>	USD 0	USD 0
	31/12/2023	15/07/2024						
<b>Samlet omsætning</b>	USD 0	USD 0						



<b>Driftsresultat/-tab</b>	USD -2'473.03	USD -30'150.54
<b>Nettooverskud/-tab</b>	USD -2'473.03	USD -30'150.54

### Balance

	31/12/2023	15/07/2024
<b>Samlede aktiver</b>	USD 50'184.35	USD 75'244.30
<b>Egenkapital i alt</b>	USD 47.526,97	USD 19'849.46
<b>Finansiell nettogæld (langfristet gæld plus kortfristet gæld minus kontanter)</b>	USD 0	USD 0

### Pengestrømsopgørelse

	31/12/2023	15/07/2024
<b>Relevante nettopengestrømme fra driftsaktiviteter</b>	USD 0	USD 0
<b>Relevante nettopengestrømme fra investeringsaktiviteter</b>	USD 0	USD 0
<b>Relevant netto Pengestrømme fra finansieringsaktiviteter</b>	USD 0	USD 0

Udsteders fremtidsudsigter er ikke blevet væsentligt forringet siden datoen for delårsbalancen pr. 15/07/2024. Der er ikke sket væsentlige ændringer i Udsteders finansielle stilling eller handelsposition siden rapporteringsdatoen for mellembalancen pr. 15/07/2024.

## 2.3 Hvad er de vigtigste risici, der er specifikke for udsteder?

### 2.3.1 Lav kapital

Udsteders formål er kommercialisering af AWEAREs teknologi. Udsteders egenkapital er begrænset til USD 50.000,00, hvor minimumskapitalen i henhold til Liechtensteins lovgivning er USD 50.000,00. Da Udsteder blev stiftet den 30/11/2023, er der ingen væsentlige historiske finansielle data eller nøgletal, bortset fra de historiske finansielle oplysninger, der er nævnt i afsnit 2.2.1 i dette resumé, til rådighed for at vurdere Udsteders finansielle situation i forhold til de seneste år. Udsteder er ikke underlagt en almindelig revision og har ikke en revisionsgennemgang. Udsteder er ikke blevet vurderet af et ratingbureau. Lav egenkapital udgør en øget risiko for investor, da funktionen som ansvarlig kapital er tilsvarende reduceret.

### Risiko for insolvens

I tilfælde af at der indledes insolvensbehandling af Udsteders aktiver, vil Udsteder midlertidigt eller permanent være begrænset i afhændelsen af sine aktiver, eller afhændelsen af Udsteders aktiver vil blive overtaget af en domstolsudpeget insolvensadministrator. Dette kan have en negativ indvirkning på Udsteders finansielle stilling og forretningsaktiviteter. Dette tilfælde kan forekomme, selv hvis insolvensansøgninger blev indgivet forkert. I tilfælde af udstederens insolvens hæfter deltagerne med deres investerede kapital. Den investerede kapital skal behandles som egenkapital og er derfor kvalificeret efterstillet.

### Finansiering af virksomheder

Der er ingen minimumskapital, der skal rejses. Der er ingen placeringsgaranti, men snarere en risiko for, at AWEARE Global Tokens ikke bliver fuldtægnet (placeringsrisiko). Hvis det ikke lykkes for udstederen at opnå den ønskede udstedelsesvolumen, vil udstederen være i stand til at investere mindre. Der er risiko for kapitalmangel for udstederen. Derudover vil emissionsomkostningerne, som er uafhængige af mængden af rejst kapital, forblive, hvilket vil øge omkostningsprocenten i forhold til den samlede rejste investeringskapital. Der er en risiko for, at udstederen i dette tilfælde ikke vil nå sine tilsigtede investeringsmål og ikke vil være i stand til at opfylde sine forpligtelser i henhold til AWEARE Global Tokens.

### Ledelse, teknologi, afhængighed af tredjepartsleverandører, konkurrence og tidsrammer for udvikling

En af udstederens vigtigste styrker er dens kloge brug af den nyeste radarteknologi. Tekniske fordele i informations- og kommunikationsteknologibranchen kan dog være kortvarige. Derfor vil udstedelsens succes til dels afhænge af dens evne til at administrere og udvide udstederens tjenester og øge virksomhedens brugerbase og dermed generere indtægter som reaktion på skiftende teknologier, brugeres og tredjepartsudbyderes krav og

	<p>konkurrencepres. Hvis dette ikke lykkes eller forsinkes, kan det have en negativ indvirkning på udstederens succes.</p> <p><b>Menneskelige fejl med smarte kontrakter</b> Udsteder påtager sig intet ansvar og fremsætter ingen erklæringer eller garantier med hensyn til funktionaliteten af udstederens projekt eller af eventuelle smarte kontrakter, der kan programmeres eller bruges til afvikling af udbuddet i overensstemmelse med dette prospekt i bredeste forstand. Investorer kan lide værdiforringelse som følge heraf eller generelt stå over for et totalt tab. I sådanne scenarier kan der dog gælde juridiske mekanismer for at beskytte en investor mod tab.</p>	
<b>AFSNIT 3 - NØGLEOPLYSNINGER OM VÆRDIPAPIRERNE</b>		
<b>3.1</b>	<b>Hvad er de vigtigste egenskaber ved værdipapirerne?</b>	
<b>3.1.1</b>	<b>Oplysninger om værdipapirerne</b>	
<b>a)</b>	<b>Beskrivelse af værdipapirernes type og klasse</b>	De <b>1.400.000</b> nye deltagelsesbeviser, der udbydes offentligt af udstederen, er ikke-stemmeberettigede ihændeleverdeltagelsesbeviser, hver med en nominal værdi på <b>USD 0,01</b> af deltagelseskapitalen (" <b>AWEARE Global Tokens</b> "). fra en ny udstedelse af deltagelseskapital besluttet af en ekstraordinær generalforsamling den 18/07/2024. Indehavere af AWEARE Global Tokens kaldes " <b>Deltagere</b> " eller " <b>Tokenholdere</b> ".
<b>b)</b>	<b>Valuta for udstedelse af værdipapirer</b>	Amerikanske dollar (" <b>USD</b> " eller " <b>\$</b> "). Løbetiden for AWEARE Global Token er ubegrænset.
<b>c)</b>	<b>Beskrivelse af de rettigheder, der er knyttet til værdipapirerne</b>	<p><b>Ret til at stemme</b> AWEARE Global Tokens er deltagelsesbeviser uden stemmeret og giver ikke deltageren ret til at stemme på, indkalde til og deltage i udstederens generalforsamling. Desuden giver AWEARE Global Tokens ikke ret til information, ret til inspektion og ret til at indgive en ansøgning. En skriftlig anmodning om information eller inspektion eller om indledning af en officiel revision kan dog indgives til generalforsamlingen.</p> <p><b>Meddelelse om indkaldelse til og beslutninger på generalforsamlingen</b> Deltagerne skal underrettes om indkaldelsen til generalforsamlingen sammen med punkterne på dagsordenen og forslagene. Alle generalforsamlingsbeslutninger skal straks gøres tilgængelige for deltagerne på udstederens hjemsted. Deltagerne skal informeres om dette i indkaldelsen.</p> <p><b>Ret til udbytte og andel af likvidationsprovenu</b> AWEARE Global Tokens har fuld ret til udbytte fra datoen for gyldig erhvervelse og giver deres indehavere ret til en andel af likvidationsprovenuet i forhold til deres deltagelse i indskudskapitalen. Udstederen planlægger i øjeblikket ikke at udbetale udbytte i den nærmeste fremtid. Selvom der findes et krav på udbytte i henhold til vedtægterne, er der ingen prognoser for fremtidige udbytteudlodninger. Udsteder har til hensigt at geninvestere overskud i yderligere vækst og udvikling af virksomheden.</p> <p><b>Form og securitisering</b> AWEARE Global Tokens vil blive udstedt som tokens. Tokens er værdirettigheder, der udstedes på en decentral database (Blockchain) og overføres dertil. Den Blockchain, der bruges til dette formål, er Ethereum Blockchain.</p> <p><b>Udelukkelse af tegningsrettigheder og deltagelsesrettigheder</b> Indtil målkapitalen på USD 50.000 er nået, er præferencerrettighederne i henhold til artikel 304d, 304f og 304g i PCL, især deltagernes tegningsrettigheder og deltagelsesrettigheder, udelukket.</p> <p><b>Værdipapirernes omsættelighed</b> Overførsel (såsom overførsel i snæver forstand, pantsætning, arv) af AWEARE Global Tokens kræver godkendelse af udstederens bestyrelse. Overførsel er derfor begrænset til en vis grad. Under alle omstændigheder er en overførsel af AWEARE Global Tokens ikke tilladt, hvis de derefter vil blive ejet af en person i et land, hvor AWEARE Global Tokens ikke må udbydes. En overførsel i ovennævnte forstand anses også for at forekomme, hvis en Tokenholder flytter sin bopæl til et land, hvor AWEARE Global Tokens ikke må udbydes.</p>
<b>d)</b>	<b>Værdipapirernes relative prioritet i udstederens kapitalstruktur i tilfælde af insolvens</b>	I tilfælde af udstederens insolvens hæfter deltagerne med deres investerede kapital. Den investerede kapital skal behandles som egenkapital og er derfor kvalificeret efterstillet.

e)	<b>Beskrivelse af udbyttepolitik</b>	Der er ikke udbetalt udbytte til dato. Udsteder udarbejder ikke overskudsprognoser eller -estimer, og der gives derfor ikke en beskrivelse af udbyttepolitikken. Eventuelt udbytte vil blive udbetalt i USD. Udsteder forbeholder sig ret til også at udbetale udbytte i en anden valuta eller kryptovaluta. Enhver beslutning om at udbetale udbytte vil blive truffet i overensstemmelse med gældende lovgivning og vil bl.a. afhænge af Udsteders driftsresultater, finansielle stilling, kontraktlige begrænsninger og kapitalkrav. Under alle omstændigheder vil 5 % af nettoresultatet blive afsat til de lovpligtige reserver, indtil dette beløb har nået 10 % af den indbetalte aktiekapital.
<b>3.2</b>	<b>Hvor vil værdipapirerne blive handlet?</b>	
<b>3.2.1</b>	AWEARE Global Tokens er ikke optaget til handel på et reguleret marked. Udstederen forbeholder sig ret til at ansøge om optagelse til handel på et reguleret marked.	
<b>3.4</b>	<b>Hvad er de vigtigste risici, der er specifikke for værdipapirerne?</b>	
<b>3.4.1</b>	<p><b>Risiko for investorers tegnebog og private nøgler</b> Investoren bærer alene risikoen for valget af wallet eller placeringen af den private nøgle. Hvis der anvendes en inkompatibel wallet, eller hvis den private nøgle går tabt, er det normalt umuligt at få adgang til AWEARE Global Tokens. Konsekvenserne, såsom det totale tab af investeringen, skal udelukkende bæres af investoren.</p> <p><b>Risiko for salgbarhed, likviditet og realisering</b> Der er ingen sikkerhed for, at der vil udvikle sig et likvidt marked for AWEARE Global Tokens. Som et resultat kan AWEARE Global Tokens ikke sælges på et sekundært marked, hvilket skaber likviditetsrisiko for investoren.</p> <p><b>Volatilitetsrisiko</b> Der er risici i forbindelse med aktiekursens volatilitet. Hvis AWEARE Global Tokens skulle blive solgt, og de blev fanget i et kraftigt nedadgående prisudsving, kunne Tokenholderen lide tab, hvoraf nogle kunne være betydelige, som følge af salget.</p> <p><b>Tab af poletter</b> Tokens kan gå tabt eller blive utilgængelige, især hvis Tokenholderen mister den respektive private nøgle til at bortskaffe sine AWEARE Global Tokens eller på grund af funktionsfejl i den e-wallet, hvor AWEARE Global Tokens er gemt. Dette kan resultere i tab af tokens. Det er Tokenholders eget ansvar at opbevare og beskytte den private nøgle, der giver adgang til e-wallet, på en sikker måde. Tokens kan også blive utilgængelige i tilfælde af en Tokenholders død, hvis han eller hun ikke har truffet foranstaltninger til sådanne tilfælde. Hverken udstederen eller noget andet organ eller institution vil være i stand til at genoprette adgangen til tokenholderens wallet for tokenholderens efterfølgere. Tabet af private nøgler kan desuden reducere tilgængeligheden af forskellige funktioner i STO'en og AWEARE Global Tokens. Især kan det være umuligt at udstede AWEARE Global Tokens til abonnenter eller at gøre dem overførbare, i hvilket tilfælde de vil forblive sat på pause på ubestemt tid. Desuden kan det være umuligt at foretage udbyttebetalinger. Endelig er der en risiko for, at en angriber kan præge AWEARE Global Tokens til ikke-bidragydende adresser, ændre bekræftelsesstatus, bidrage med ukontrollerede beløb til STO'en eller give angriberen mulighed for at trække uopkrævede udbyttebetalinger tilbage.</p> <p><b>Begrænsede rettigheder for Tokenholder</b> AWEARE Global Tokens er deltagerbeviser uden stemmeret og giver ikke Tokenholderne ret til at stemme på, indkalde til og deltage i Udsteders generalforsamling. Desuden giver AWEARE Global Tokens ikke ret til information, ret til inspektion og ret til at indgive en ansøgning. Udstederens generalforsamling kan derfor vedtage beslutninger, der kan påvirke tokenholdernes rettigheder negativt. Tokenholdere har ingen mulighed for at kontrollere brugen af provenuet fra udstedelsen af AWEARE Global Tokens. Overførsel (såsom overførsel i snæver forstand, pantsætning, arv) af AWEARE Global Tokens kræver godkendelse af udstederens bestyrelse. Under alle omstændigheder er en overførsel af AWEARE Global Tokens ikke tilladt, hvis de derefter vil blive ejet af en person i et land, hvor AWEARE Global Tokens ikke må udbydes. En overførsel i ovenstående forstand anses også for at forekomme, hvis en Tokenholder flytter sin bopæl til et land, hvor AWEARE Global Tokens ikke må udbydes. Tokenholdernes lovbestemte tegningsret i tilfælde af en kapitalforhøjelse i henhold til dette tilbud er udelukket.</p> <p><b>Tokenholdernes krav er efterstillet</b> Tokenholdernes ret til at kræve og modtage udbyttebetalinger fra udstederen er efterstillet kravene fra alle indehavere af udstederens ikke-efterstillede forpligtelser. I en likvidation af Udsteder vil Tokenholdere kun blive betalt, hvis og efter at alle Udsteders seniorforpligtelser er blevet indfriet.</p>	
<b>AFSNIT 4 - NØGLEOPLYSNINGER OM UDBUDET AF VÆRDIPAPIRER TIL OFFENTLIGHEDEN</b>		
<b>4.1</b>	<b>Under hvilke betingelser og med hvilken tidsplan kan jeg investere i dette værdipapir?</b>	
<p><b>Lande, hvor værdipapirerne udbydes</b> Udbuddet består af offentlige udbud i Østrig, Belgien, Bulgarien, Kroatien, Cypern, Tjekkiet, Danmark, Estland, Finland, Frankrig, Tyskland, Grækenland, Ungarn, Island, Irland, Italien, Letland, Liechtenstein, Litauen, Luxembourg, Malta, Holland, Norge, Polen, Portugal, Rumænien, Slovakiet, Slovenien, Spanien, Sverige og Schweiz samt private placeringer i visse jurisdiktioner uden for disse lande.</p>		

#### Lande, hvor værdipapirerne ikke udbydes

Udsteders AWEARE Global Tokens er ikke og vil ikke blive registreret i henhold til bestemmelserne i United States Securities Act fra 1933 med senere ændringer eller hos de værdipapirregulerende myndigheder i nogen stat i USA eller i Australien, Japan eller Canada. Følgelig vil de ikke blive udbudt, solgt eller leveret direkte eller indirekte til offentligheden, undtagen i henhold til en undtagelse fra registreringskravene. I særdeleshed udgør dette prospekt ikke et tilbud om at sælge eller en opfordring til et tilbud om at købe AWEARE Global Tokens i USA, Australien, Japan og Canada, og det må ikke distribueres der. Derudover udgør eller udgør dette prospekt ikke et tilbud om at sælge eller opfordre til et tilbud om at købe AWEARE Global Tokens i Rusland, Iran eller Nordkorea, Hviderusland, Syrien eller nogen territorier deraf. Og må ikke distribueres deri.

#### Budgivning

Tegningsprocessen for AWEARE Global Tokens vil finde sted online på <https://kyc.awearetech.li/> ("Dashboard").

#### Tilbudsperiode

Den periode, hvor investorer kan afgive købstilbud på AWEARE Global Tokens, begynder på datoen for godkendelse af prospektet og slutter et år senere ("**Tilbudsperioden**"). På Tilbudsperiodens sidste dag kan der afgives købstilbud indtil kl. 12:00 Liechtensteiner tid.

#### Budpris

Budprisen for en AWEARE-token er **USD 12,00** ("**Budprisen**").

For at tilskynde til tidlig investering er følgende rabatter tilgængelige:

For investeringer mellem 10.000 USDC og 49.999,99 USDC vil investorer modtage en rabat på 10%, hvilket gør prisen pr. AWEARE Token til 10,80 USD.

For investeringer på 50.000 USDC eller mere vil investorer modtage en rabat på 15%, hvilket gør prisen per AWEARE Token til 10,20 USD.

#### Tilgængelighed af rabatter

Ovenstående rabatter er tilgængelige, **indtil et af følgende indtræffer, afhængigt af hvad der kommer først:**

- **når en samlet investeringsvolumen på 5.000.000 USDC**, eller
- **udløb af tre måneder fra tilbuddets start.**

#### Levering og afregning

Hver investor skal gennemføre online-tegningsprocessen på dashboardet. AWEARE Global Tokens vil blive tildelt off-chain som en post i udstederens database, som kan ses via dashboardet, mod betaling af budprisen. AWEARE Global Tokens vil blive tildelt on-chain i Smart Contract senest inden for to måneder efter afslutningen af tilbudsperioden. Når det samlede udbud af AWEARE Global Tokens (efter at have nået målet for deltageskapital) er afsluttet, og udstederen har besluttet at færdiggøre Smart Contract, vil AWEARE Global Tokens blive leveret til investorens crypto-tegnebog.

#### Fortynding

Da den lovbestemte tegningsret for alle deltagere er udelukket i tilfælde af en kapitalforhøjelse i forbindelse med dette tilbud, vil deltagerne i dette tilbud ikke blive udvandet.

#### Samlet nettoprovenu og anslåede udstedelsesomkostninger

Det samlede nettoprovenu af udbuddet over 1.400.000 AWEARE Global Tokens kan beløbe sig til ca. **USD 15.000.000** svarende til gennemførelsen af kapitalforhøjelsen. De forventede samlede omkostninger ved udbuddet beløber sig til ca. **USD 1.500.000** og vil blive opkrævet fra provenuet.

<b>4.2</b>	<b>Hvorfor bliver dette prospekt udarbejdet?</b>
<b>4.2.1</b>	<p>a) Det anslåede nettoprovenu fra udstedelsen af værdipapirerne vil primært blive brugt til forskning og udvikling og IP-beskyttelse. Det kan være nødvendigt at flytte op til 50 % af et tildelt budget til en anden position, hvis det er nødvendigt.</p> <ul style="list-style-type: none"><li>i) 10% omkostninger ved forhøjelse</li><li>ii) 11% Generelt og administrativt</li><li>iii) 41% Forskning og udvikling</li><li>iv) 17% Juridisk (global IP-beskyttelse)</li><li>v) 21% Busudvikling, salg og marketing</li></ul> <p>b) De nuværende aktionærer i AWEARE Technologies Inc. og Global Innovation Partners Limited omfatter Mahesh Reddy og Dr. Daniel Hyman. Mahesh Reddy og Dr. Daniel Hyman er også bestyrelsesmedlemmer og minoritetsaktionærer i Udsteder.</p> <p>c) Equanimity AG modtager et transaktionsgebyr på 3 % af de samlede kryptovalutaer og fiat-betalinger, der er påløbet. Marcel Füssinger, som er en af udstederens direktører, er også direktør og ejer af Equanimity AG.</p> <p>d) <b>Samlet nettoprovenu og anslåede udstedelsesomkostninger</b></p>

	<p>Det samlede nettoprovenu af udbuddet over 1.400.000 AWEARE Global Tokens kan beløbe sig til ca. <b>USD 15.000.000</b> svarende til gennemførelsen af kapitalforhøjelsen. De forventede samlede omkostninger ved udbuddet beløber sig til ca. <b>USD 1.500.000</b> og vil blive opkrævet fra provenuet.</p> <p>e) <b>Forsikringsordninger</b> Udbuddet er ikke underlagt en fast garantiaftale. Der er ingen aftale, hvorunder en garantistiller er forpligtet til at garantere usolgte tokens. Derfor er der ingen garanti for, at hele udbuddet vil blive placeret.</p>
--	---

## VII. РЕЗЮМЕ НА ПРОСПЕКТА

Това резюме съдържа всички елементи, които се изисква да бъдат включени в резюме за този вид ценни книжа и емитент.

РАЗДЕЛ 1 - ВЪВЕДЕНИЕ		
1.1	Име и ISIN на ценните книжа	Публично обявените <b>1 400 000</b> нови сертификати за участие са сертификати за участие на приносител без право на глас на AWEARE Global AG. Наименованието на тези сертификати за участие е "AWEARE Global Tokens". ISIN е LI1363014385.
1.2	Данни за самоличност и контакт с емитента, включително идентификатор на юридическото лице (LEI)	<b>AWEARE Global AG ("Емитентът")</b> c/o Revalier Aktiengesellschaft Pradafant 11, 9490 Vaduz, Княжество Тел: +423 237 63 47 Имейл: info@awearetech.li LEI e: 391200PTNEZNXGJW1C39
1.3	Компетентен орган	<b>Орган за управление на финансовите пазари ("FMA")</b> Landstrasse 109, 9490 Вадуц, Княжество Лихтенщайн Тел: +423 236 73 73 Факс: +423 236 73 74 Имейл: <a href="mailto:info@fma-li.li">info@fma-li.li</a>
1.4	Дата на одобрение на проспекта	05/12/2024
1.5	Предупреждения	
1.5.1	<p>a) Резюмето следва да се чете като въведение към настоящия проспект. Всяко решение за инвестиране в ценните книжа трябва да се основава на разглеждането на Проспекта като цяло от инвеститора.</p> <p>b) Инвеститорът може да загуби целия или част от инвестирания капитал.</p> <p>c) Когато искът, свързан с информацията, съдържаща се в проспекта, е предявен пред съда, инвеститорът-ищец може да се наложи, съгласно националното законодателство, да поеме разходите за превод на проспекта преди започване на съдебното производство.</p> <p>d) Гражданска отговорност носят само лицата, които са представили резюмето, включително и неговия превод, но само ако резюмето е подвеждащо, неточно или несъответстващо, когато се чете заедно с другите части на проспекта, или не предоставя, когато се чете заедно с другите части на проспекта, ключова информация, която да помогне на инвеститорите да преценят дали да инвестират в ценните книжа.</p>	
РАЗДЕЛ 2 - ОСНОВНА ИНФОРМАЦИЯ ЗА ЕМИТЕНТА		
2.1	Кой е емитентът на ценните книжа?	
2.1.1	Информация за емитента	
	<p>a) Юридическото и търговското наименование на Емитента е "AWEARE Global AG". Емитентът е акционерно дружество, учредено в Княжество Лихтенщайн и регулирано от законите на Княжество Лихтенщайн. Емитентът е със седалище във Вадуц, Княжество Лихтенщайн, и е регистриран в Службата на правосъдието / Търговския регистър на Княжество Лихтенщайн под регистрационен номер FL-0002.714.015-4.</p> <p>b) Целта на Емитента е да разработва и осребрява сензорни технологии и изкуствен интелект за автономни превозни средства и други приложения.</p> <p>c) Основните акционери на Емитента са:</p>	

	<ul style="list-style-type: none"> <li>Global Innovation Partners Limited, Британски Вирджински острови, с мажоритарни акционери д-р Даниел Хайман, Махеш Реди, д-р Реджиналд Танг и Марк Хайман</li> </ul> <p>d) Съветът на директорите на Емитента се състои от:</p> <ul style="list-style-type: none"> <li>Д-р Даниел Хайман, националност: САЩ, Пощенски адрес: Лонг Бийч, Калифорния, САЩ</li> <li>Maresh Reddy, националност: САЩ, Пощенски адрес: Ървайн, Калифорния, САЩ</li> <li>Марсел Фюсингер, националност: Австрия, Пощенски адрес: 160009, Сингапур</li> <li>Revalier AG, представлявано от Reinhold Wohlwend, Гражданство: Лихтенщайн, пощенски адрес: 9490, Вадуц, Лихтенщайн</li> </ul> <p>e) Одиторът е: Лукас Тихани, член на Асоциацията на одиторите на Лихтенщайн и EXPERTsuisse, Industriering 14, 9491 Ruggell, LLechtenstein</p>																																				
<b>2.2</b>	<b>Каква е основната финансова информация за емитента?</b>																																				
<b>2.2.1</b>	<p>Емитентът е учреден на 30.11.2023 г. с вписване в търговския регистър на Княжество Лихтенщайн. Съгласно декларацията на Съвета на директорите от 25 октомври 2023 г. Емитентът не подлежи на обикновен одит и не е обект на одиторски преглед. Въпреки това годишните финансови отчети към 31 декември 2023 г. и междинните финансови отчети към 15 юли 2023 г. са одитирани от Одитора.</p> <p>Следната основна финансова информация е изготвена в съответствие с разпоредбите на Закона за лицата и дружествата на Лихтенщайн ("ЗЛС"), и по-специално чл. 1024 и следващите.</p> <p style="text-align: center;"><b>Отчет за приходите и разходите</b></p> <table border="1" style="width: 100%; border-collapse: collapse;"> <thead> <tr> <th></th> <th style="text-align: center;">31/12/2023</th> <th style="text-align: center;">15/07/2024</th> </tr> </thead> <tbody> <tr> <td>Общи приходи</td> <td style="text-align: center;">USD 0</td> <td style="text-align: center;">USD 0</td> </tr> <tr> <td>Оперативна печалба/загуба</td> <td style="text-align: center;">USD -2'473.03</td> <td style="text-align: center;">USD -30'150.54</td> </tr> <tr> <td>Нетна печалба/загуба</td> <td style="text-align: center;">USD -2'473.03</td> <td style="text-align: center;">USD -30'150.54</td> </tr> </tbody> </table> <p style="text-align: center;"><b>Баланс</b></p> <table border="1" style="width: 100%; border-collapse: collapse;"> <thead> <tr> <th></th> <th style="text-align: center;">31/12/2023</th> <th style="text-align: center;">15/07/2024</th> </tr> </thead> <tbody> <tr> <td>Общо активи</td> <td style="text-align: center;">USD 50'184.35</td> <td style="text-align: center;">USD 75'244.30</td> </tr> <tr> <td>Общ собствен капитал</td> <td style="text-align: center;">USD 47,526.97</td> <td style="text-align: center;">19'849,46 USD</td> </tr> <tr> <td>Нетен финансов дълг (дългосрочен дълг плюс краткосрочен дълг минус парични средства)</td> <td style="text-align: center;">USD 0</td> <td style="text-align: center;">USD 0</td> </tr> </tbody> </table> <p style="text-align: center;"><b>Отчет за паричните потоци</b></p> <table border="1" style="width: 100%; border-collapse: collapse;"> <thead> <tr> <th></th> <th style="text-align: center;">31/12/2023</th> <th style="text-align: center;">15/07/2024</th> </tr> </thead> <tbody> <tr> <td>Съответни нетни парични потоци от оперативна дейност</td> <td style="text-align: center;">USD 0</td> <td style="text-align: center;">USD 0</td> </tr> <tr> <td>Съответни нетни Парични потоци от инвестиционна дейност</td> <td style="text-align: center;">USD 0</td> <td style="text-align: center;">USD 0</td> </tr> <tr> <td>Съответни нетни Парични потоци от финансова дейност</td> <td style="text-align: center;">USD 0</td> <td style="text-align: center;">USD 0</td> </tr> </tbody> </table> <p>Перспективата на Емитента не се е влошила значително след датата на междинния баланс към 15.07.2024 г. Не са настъпили съществени промени във финансовото състояние или търговската позиция на Емитента след датата на отчитане на междинния баланс към 15.07.2024 г.</p>		31/12/2023	15/07/2024	Общи приходи	USD 0	USD 0	Оперативна печалба/загуба	USD -2'473.03	USD -30'150.54	Нетна печалба/загуба	USD -2'473.03	USD -30'150.54		31/12/2023	15/07/2024	Общо активи	USD 50'184.35	USD 75'244.30	Общ собствен капитал	USD 47,526.97	19'849,46 USD	Нетен финансов дълг (дългосрочен дълг плюс краткосрочен дълг минус парични средства)	USD 0	USD 0		31/12/2023	15/07/2024	Съответни нетни парични потоци от оперативна дейност	USD 0	USD 0	Съответни нетни Парични потоци от инвестиционна дейност	USD 0	USD 0	Съответни нетни Парични потоци от финансова дейност	USD 0	USD 0
	31/12/2023	15/07/2024																																			
Общи приходи	USD 0	USD 0																																			
Оперативна печалба/загуба	USD -2'473.03	USD -30'150.54																																			
Нетна печалба/загуба	USD -2'473.03	USD -30'150.54																																			
	31/12/2023	15/07/2024																																			
Общо активи	USD 50'184.35	USD 75'244.30																																			
Общ собствен капитал	USD 47,526.97	19'849,46 USD																																			
Нетен финансов дълг (дългосрочен дълг плюс краткосрочен дълг минус парични средства)	USD 0	USD 0																																			
	31/12/2023	15/07/2024																																			
Съответни нетни парични потоци от оперативна дейност	USD 0	USD 0																																			
Съответни нетни Парични потоци от инвестиционна дейност	USD 0	USD 0																																			
Съответни нетни Парични потоци от финансова дейност	USD 0	USD 0																																			
<b>2.3</b>	<b>Кои са основните рискове, които са специфични за емитента?</b>																																				
<b>2.3.1</b>	<b>Нисък капитал</b>																																				

	<p>Целта на Емитента е комерсиализацията на технологията на AWEARE. Собственият капитал на Емитента е ограничен до 50 000,00 щатски долара, като минималният капитал, изискван съгласно законодателството на Лихтенщайн, е 50 000,00 щатски долара. Тъй като Емитентът е учреден на 30.11.2023 г., не са налични значителни исторически финансови данни или ключови цифри, различни от историческата финансова информация, посочена в раздел 2.2.1 от настоящото резюме, за да се оцени финансовото състояние на Емитента по отношение на последните години. Емитентът не подлежи на обикновен одит и не е обект на одиторски преглед. Емитентът не е бил оценяван от рейтингова агенция. Ниският размер на собствения капитал представлява повишен риск за инвеститора, тъй като функцията му на отговорен капитал съответно намалява.</p> <p><b>Риск от неплатежоспособност</b></p> <p>В случай на откриване на производство по несъстоятелност върху активите на Емитента, Емитентът ще бъде временно или постоянно ограничен в разпоредването с активите си или разпоредването с активите на Емитента ще бъде поето от назначен от съда синдик по несъстоятелността. Това може да има отрицателно въздействие върху финансовото състояние и стопанската дейност на Емитента. Този случай може да настъпи дори ако молбите за обявяване в несъстоятелност са подадени неправилно. В случай на неплатежоспособност на Емитента, Участниците носят отговорност с инвестирания от тях капитал. Инвестираният капитал трябва да се третира като собствен капитал и следователно е квалифицирано подчинен.</p> <p><b>Финансиране на бизнеса</b></p> <p>Няма минимален капитал, който да бъде набран. Няма гаранция за пласиране, а по-скоро риск, че глобалните токени на AWEARE няма да бъдат напълно записани (риск от пласиране). Ако Емитентът не успее да набере желания обем на емисията, той ще може да инвестира по-малко. Съществува риск от недостиг на капитал за Емитента. Освен това разходите за емисии, които не зависят от размера на набрания капитал, ще останат, което ще увеличи съотношението на разходите спрямо общия размер на набрания инвестиционен капитал. Съществува риск, че в този случай Емитентът няма да постигне планираните инвестиционни цели и няма да може да изпълни задълженията си по AWEARE Global Tokens.</p> <p><b>Управление, технологии, зависимост от трети страни доставчици на услуги, конкуренция и срокове за развитие</b></p> <p>Едно от ключовите предимства на Емитента е умелото използване на най-новите радарни технологии. Въпреки това техническите предимства в сектора на информационните и комуникационните технологии могат да бъдат краткотрайни. Съответно успехът на емисията ще зависи отчасти от нейната способност да управлява и разширява услугите на Емитента и да увеличава потребителската база на бизнеса си, а оттам и да генерира приходи в отговор на променящите се технологии, изискванията на потребителите и на трети страни - доставчици на услуги, и на конкурентния натиск. Неуспехът или закъснението в това отношение може да се отрази неблагоприятно на успеха на Емитента.</p> <p><b>Човешка грешка при интелигентните договори</b></p> <p>Емитентът не поема никаква отговорност и не прави никакви изявления или гаранции относно функционалността на проекта на Емитента или на интелигентните договори, които могат да бъдат програмирани или използвани за сетълмент на предлагането в съответствие с настоящия Проспект в най-широк смисъл. В резултат на това инвеститорите могат да претърпят обезценка или като цяло да бъдат изправени пред пълна загуба. При такива сценарии обаче могат да се прилагат правни механизми за защита на инвеститора от загуби.</p>
<b>РАЗДЕЛ 3 - ОСНОВНА ИНФОРМАЦИЯ ЗА ЦЕННИТЕ КНИЖА</b>	
3.1	Какви са основните характеристики на ценните книжа?
3.1.1	Информация за ценните книжа
a)	<p><b>Описание на вида и класа на ценните книжа</b></p> <p>Публично предлаганите от Емитента <b>1 400 000</b> нови удостоверения за участие са удостоверения за участие на приносител без право на глас, всяко с номинална стойност <b>0,01 щатски долара</b> от капитала за участие ("<b>AWEARE Global Tokens</b>"), от нова емисия капитал за участие, одобрена от извънредно Общо събрание на 18.07.2024 г. Притежателите на глобални токени на AWEARE се наричат "<b>Участници</b>" или "<b>Притежатели на токени</b>".</p>
b)	<p><b>Валута на емисията ценни книжа</b></p> <p>Долар на Съединените американски щати ("<b>USD</b>" или "<b>\$</b>"). Срокът на валидност на AWEARE Global Token е неограничен.</p>
c)	<p><b>Описание на правата, свързани с ценните книжа</b></p> <p><b>Право на глас</b> AWEARE Global Tokens са сертификати за участие без право на глас и не дават право на Участника да гласува, да свиква и да участва в Общото събрание на Емитента. Освен това глобалните токени AWEARE не дават право на информация, право на проверка и право на подаване на заявление. Въпреки това, на Общото събрание може да бъде подадено писмено искане за информация или проверка, или за започване на официален одит.</p> <p><b>Съобщение за свикването и решенията на Общото събрание</b> Участниците трябва да бъдат уведомени за свикването на Общото събрание,</p>

		<p>както и за точките от дневния ред и предложенията. Всяко решение на Общото събрание трябва незабавно да бъде предоставено на разположение на участниците за проверка в седалището на Емитента. Участниците трябва да бъдат информирани за това в уведомлението.</p> <p><b>Право на дивидент и дял от постъпленията от ликвидацията</b> Токените AWEARE Global Tokens носят пълни права на дивидент от датата на валидното им придобиване и дават право на притежателите си на дял от приходите от ликвидацията, пропорционален на участието им в капитала за участие. Понастоящем Емитентът не планира да разпределя дивиденти в близко бъдеще. Въпреки че съгласно Устава на Емитента съществува право на дивидент, не се правят прогнози относно бъдещото разпределение на дивиденти. Емитентът възнамерява да реинвестира печалбите в по-нататъшния растеж и развитие на дружеството.</p> <p><b>Форма и секюритизация</b> AWEARE Global Tokens ще се емитират като токени. Токените са права на стойност, които се издават в децентрализирана база данни (Blockchain) и се прехвърлят там. Използваната за тази цел блокчейн е блокчейнът на Ethereum.</p> <p><b>Исключване на права на записване и права на участие</b> До достигане на целевия капитал за участие от 50 000 USD се изключват преференциалните права съгласно членове 304г, 304е и 304ж от ЗППЦК, по-специално правата на записване и правата на участие на участниците.</p> <p><b>Прехвърляемост на ценните книжа</b> Прехвърлянето (като например прехвърляне в тесен смисъл, залагане, наследяване) на глобалните токени на AWEARE изисква одобрението на Съвета на директорите на Емитента. Поради това прехвърлимостта е ограничена до известна степен. Във всеки случай прехвърлянето на AWEARE Global Tokens не е разрешено, ако след това те ще бъдат притежавани от лице в държава, в която AWEARE Global Tokens не могат да бъдат предлагани. Прехвърляне в горния смисъл се счита за извършено и ако притежателят на токени премести местожителството си в държава, в която глобалните токени на AWEARE не могат да бъдат предлагани.</p>
d)	<b>Относителна старшинство на ценните книжа в капиталовата структура на емитента в случай на несъстоятелност</b>	В случай на неплатежоспособност на емитента участниците носят отговорност с инвестирания от тях капитал. Инвестираният капитал трябва да се третира като собствен капитал и следователно е квалифицирано подчинен.
e)	<b>Описание на дивидентната политика</b>	До момента не са изплащани дивиденти. Емитентът не прави прогнози или оценки на печалбата и поради това не се прави описание на дивидентната политика. Дивидентите, ако има такива, ще бъдат изплатени в щатски долари. Емитентът си запазва правото да изплаща дивиденти и в друга валута или криптовалута. Всяко решение за изплащане на дивиденти ще бъде взето в съответствие с приложимото законодателство и ще зависи, inter alia, от резултатите от дейността на Емитента, финансовото му състояние, договорните ограничения и капиталовите изисквания. Във всеки случай 5% от нетната печалба ще бъдат разпределени в законовите резерви, докато те достигнат размер от 10% от внесенния акционерен капитал.
3.2	<b>Къде ще се търгуват ценните книжа?</b>	
3.2.1		AWEARE Global Tokens не са допуснати до търговия на регулиран пазар. Емитентът си запазва правото да кандидатства за допускане до търговия на регулиран пазар.
3.4	<b>Кои са основните рискове, характерни за ценните книжа?</b>	
3.4.1		<p><b>Риск за портфейла на инвеститорите и частния ключ</b> Инвеститорът сам носи риска от избора на портфейла или местоположението на частния ключ. Ако се използва несъвместим портфейл или ако частният ключ бъде изгубен, достъпът до глобалните токени на AWEARE обикновено е невъзможен. Последствията, като например пълната загуба на инвестицията, трябва да се поемат единствено от инвеститора.</p> <p><b>Риск от продажба, ликвиден риск и риск от реализация</b> Не е сигурно, че ще се развие ликвиден пазар за глобалните токени на AWEARE. В резултат на това AWEARE Global Tokens не могат да бъдат продадени на вторичен пазар, което създава ликвиден риск за инвеститора.</p>



	<p><b>Риск от променливост</b> Съществуват рискове, свързани с волатилността на цената на акциите. Ако AWEARE Global Tokens бъдат продадени и попаднат в рязко низходящо колебание на цената, притежателят на токени може да претърпи загуби, някои от които могат да бъдат значителни, в резултат на продажбата.</p> <p><b>Загуба на жетони</b> Токените могат да бъдат изгубени или да станат недостъпни, по-специално ако притежателят на токени изгуби съответния частен ключ за разпореждане със своите AWEARE Global Tokens или поради неправилно функциониране на електронния портфейл, в който се съхраняват AWEARE Global Tokens. Това може да доведе до загуба на Токените. Отговорност на притежателите на Токени е да съхраняват и опазват по сигурен начин частния ключ, който позволява достъп до електронния портфейл. Токените могат да станат недостъпни и в случай на смърт на притежателя на токени, ако той не е взел мерки за такива случаи. Нито Емитентът, нито който и да е друг орган или институция ще бъдат в състояние да възстановят достъпа до портфейла на притежателя на токени за наследниците на притежателя на токени. Загубата на частни ключове може освен това да намали достъпността на различни функционалности на STO и AWEARE Global Tokens. По-специално, може да се окаже невъзможно да се издават AWEARE Global Tokens на абонати или да се направи възможно прехвърлянето им, в който случай те ще останат спрени за неопределено време. Освен това може да се окаже невъзможно да се извършват плащания на дивиденди. И накрая, съществува риск атакуващият да изкопира AWEARE Global Tokens за адреси, които не са направили вноски, да промени статуса на потвърждение, да внесе неконтролирани суми в STO или да позволи на атакуващия да изтегли непотърсени плащания на дивиденди.</p> <p><b>Ограничени права на притежателите на токени</b> AWEARE Global Tokens са сертификати за участие без право на глас и не дават право на притежателите на токени да гласуват, да свикват и да участват в Общото събрание на Емитента. Освен това глобалните токени AWEARE не дават право на информация, право на проверка и право на подаване на заявление. Поради това Общото събрание на Емитента може да приеме решения, които могат да засегнат неблагоприятно правата на притежателите на Токени. Притежателите на токени нямат възможност да контролират използването на приходите от емитирането на глобални токени AWEARE. Прехвърлянето (като например прехвърляне в тесен смисъл, залагане, наследяване) на Глобалните токени на AWEARE изисква одобрението на Съвета на директорите на Емитента. Във всеки случай прехвърлянето на AWEARE Global Tokens не е разрешено, ако след това те ще бъдат притежавани от лице в държава, в която AWEARE Global Tokens не могат да бъдат предлагани. Прехвърляне в горния смисъл се счита за извършено и ако притежателят на токени премести местожителството си в държава, в която глобалните токени на AWEARE не могат да бъдат предлагани. Законното право на записване на притежателите на токени в случай на увеличение на капитала в рамките на тази оферта е изключено.</p> <p><b>Вземанията на притежателите на токени са подчинени</b> Правата на притежателите на токени да претендират и да получават дивиденди от Емитента са подчинени на вземанията на всички притежатели на неподчинени задължения на Емитента. При ликвидация на Емитента притежателите на токени ще бъдат изплатени само ако и след като всички първостепенни задължения на Емитента бъдат погасени.</p>
<b>РАЗДЕЛ 4 - ОСНОВНА ИНФОРМАЦИЯ ЗА ПУБЛИЧНОТО ПРЕДЛАГАНЕ НА ЦЕННИ КНИЖА</b>	
4.1	<b>При какви условия и в какъв график мога да инвестирам в тази ценна книга?</b>
<p><b>Държави, в които се предлагат ценните книжа</b> Предлагането се състои от публични предлагания в Австрия, Белгия, България, Хърватия, Кипър, Чешката република, Дания, Естония, Финландия, Франция, Германия, Гърция, Унгария, Исландия, Ирландия, Италия, Латвия, Лихтенщайн, Литва, Люксембург, Малта, Нидерландия, Норвегия, Полша, Португалия, Румъния, Словакия, Словения, Испания, Швеция, Швейцария, както и от частни предлагания в някои юрисдикции извън тях.</p> <p><b>Държави, в които ценните книжа не се предлагат</b> Глобалните токени AWEARE на Емитента не са и няма да бъдат регистрирани съгласно разпоредбите на Закона за ценните книжа на Съединените американски щати от 1933 г., както е изменен, или от регулаторните органи за ценни книжа на който и да е щат на Съединените американски щати, или в Австралия, Япония или Канада. Съответно те няма да бъдат предлагани, продавани или доставяни пряко или непряко на обществеността, освен в съответствие с освобождаване от изискванията за регистрация. По-специално, настоящият Проспект не представлява и не е оферта за продажба или покана за оферта за закупуване на AWEARE Global Tokens в Съединените американски щати, Австралия, Япония и Канада и не може да бъде разпространяван там. Освен това настоящият Проспект не представлява и не е оферта за продажба или покана за представяне на оферта за закупуване на Глобални токени AWEARE в Русия, Иран или Северна Корея, Беларус, Сирия или на други техни територии. И не може да бъде разпространяван в тях.</p> <p><b>Офериране</b> Процесът на абонамент за AWEARE Global Tokens ще се извършва онлайн на адрес <a href="https://kyc.awearetech.li/">https://kyc.awearetech.li/</a> ("Информационното табло").</p> <p><b>Период на офертата</b></p>	

Периодът, през който инвеститорите могат да подават своите оферти за покупка на глобални токени AWEARE, започва на датата на одобрение на проспекта и приключва една година по-късно ("период на предлагане"). В последния ден от Периода на предлагане оферти могат да се подават до 12:00 ч. на обяд лихтенщайнско време.

#### Офертна цена

Офертната цена на един AWEARE Token е **12,00 USD** ("Офертна цена").

За да насърчим ранното инвестиране, предлагаме следните отстъпки:

За инвестиции между 10 000 USDC и 49 999,99 USDC инвеститорите ще получат отстъпка от 10%, което прави цената на един токен AWEARE 10,80 USD.

За инвестиции от 50 000 USDC или повече инвеститорите ще получат отстъпка от 15%, което прави цената на един токен AWEARE 10,20 USD.

#### Наличност на отстъпки

Горепосочените отстъпки са налични **до настъпването на едно от следните събития, в зависимост от това кое от тях настъпи първо:**

- **достигане на общ инвестиционен обем от 5 000 000 USDC**, или
- **изтичане на три месеца от началото на офертата.**

#### Доставка и сетълмент

Всеки инвеститор трябва да завърши процеса на онлайн абонамент в Информационното табло. Токените AWEARE Global ще бъдат разпределени извън веригата като запис в базата данни на Емитента, който може да бъде видян чрез таблото за управление, срещу заплащане на цената на офертата. AWEARE Global Tokens ще бъдат разпределени on-chain в Smart Contract най-късно до два месеца след края на периода на предлагане. След като приключи общото предлагане на AWEARE Global Tokens (след достигане на целевия капитал за участие) и Емитентът реши да финализира Smart Contract, AWEARE Global Tokens ще бъдат доставени в крипто портфейла на инвеститора.

#### Разреждане

Тъй като законното право на записване на всички участници е изключено в случай на увеличение на капитала в контекста на тази оферта, участниците в тази оферта няма да бъдат разводнени.

#### Общо нетни постъпления и очаквани разходи по емисията

Общите нетни постъпления от предлагането на над 1 400 000 глобални токена на AWEARE могат да възлизат на около **15 000 000 щатски долара**, което съответства на набирането на средства. Очакваните общи разходи по офертата възлизат на приблизително **1 500 000 USD** и ще бъдат начислени от постъпленията.

## 4.2

### Защо се изготвя този проспект?

#### 4.2.1

- a) Очакваните нетни постъпления от емитирането на ценните книжа ще бъдат използвани предимно за научноизследователска и развойна дейност и защита на интелектуалната собственост. При необходимост може да се наложи прехвърляне на до 50 % от отпускания бюджет към друга позиция.
- i) 10% Разходи за повишение
  - ii) 11% Общи и административни въпроси
  - iii) 41% Изследване и развитие
  - iv) 17% Правни въпроси (глобална защита на интелектуалната собственост)
  - v) 21% Развитие на бизнеса, продажби и маркетинг
- b) Сред настоящите акционери на AWEARE Technologies Inc. и Global Innovation Partners Limited са Махеш Реди и д-р Даниел Хайман. Махеш Реди и д-р Даниел Хайман са също директори и миноритарни акционери на Емитента.
- c) Equanimity AG получава такса за транзакция в размер на 3% от общия размер на начислените плащания в криптовалута и фиатни валути. Марсел Фюсингер, който е един от директорите на Емитента, е също така директор и собственик на Equanimity AG.
- d) **Общо нетни постъпления и очаквани разходи по емисията**  
Общите нетни постъпления от предлагането на над 1 400 000 глобални токена на AWEARE могат да възлизат на около **15 000 000 щатски долара**, което съответства на набирането на средства. Очакваните общи разходи по офертата възлизат на приблизително **1 500 000 USD** и ще бъдат начислени от постъпленията.
- e) **Споразумения за подписване на договори**  
Предлагането не е предмет на твърдо споразумение за поемане на емисията. Няма споразумение, по силата на което даден поемател да е задължен да запише непродадени токени. Следователно няма гаранция, че цялото предлагане ще бъде пласирано.

## VIII. SHRnutí PROSPEKTU

Tento souhrn obsahuje všechny prvky, které musí být zahrnuty do souhrnu pro tento typ cenných papírů a emitenta.

ODDÍL 1 - ÚVOD		
1.1	Název a ISIN cenných papírů	1 400 000 nových veřejných podílových listů jsou podílové listy na doručitele bez hlasovacího práva společnosti AWEARE Global AG. Název těchto účastnických certifikátů je "AWEARE Global Tokens". ISIN je LI1363014385.
1.2	totožnost a kontaktní údaje emitenta, včetně jeho identifikátoru právnícké osoby (LEI)	<b>AWEARE Global AG ("Emitent")</b> c/o Revalier Aktiengesellschaft Pradafant 11, 9490 Vaduz, knížectví Tel: +423 237 63 47 E-mail: <a href="mailto:info@awearetech.li">info@awearetech.li</a> LEI je: 391200PTNEZNXGJW1C39
1.3	Příslušný orgán	<b>Úřad pro finanční trh (dále jen "FMA")</b> Landstrasse 109, 9490 Vaduz, Lichtenštejnské knížectví Tel: +423 236 73 73 Fax: +423 236 73 74 E-mail: <a href="mailto:info@fma-li.li">info@fma-li.li</a>
1.4	Datum schválení prospektu	05/12/2024
1.5	Varování	
1.5.1		<p>a) Toto shrnutí je třeba číst jako úvod k tomuto prospektu. Jakékoli rozhodnutí investovat do cenných papírů by mělo být založeno na zvážení Prospektu jako celku ze strany investora.</p> <p>b) Investor může přijít o celý investovaný kapitál nebo jeho část.</p> <p>c) Pokud je u soudu podána žaloba týkající se informací obsažených v prospektu, může se stát, že žalující investor bude muset podle vnitrostátního práva nést náklady na překlad prospektu před zahájením soudního řízení.</p> <p>d) Občanskoprávní odpovědnost se vztahuje pouze na osoby, které předložily shrnutí včetně jeho překladu, avšak pouze v případě, že shrnutí je zavádějící, nepřesné nebo nekonzistentní, pokud se čte společně s ostatními částmi prospektu, nebo pokud neposkytuje, pokud se čte společně s ostatními částmi prospektu, klíčové informace, které mají investorům pomoci při zvažování, zda investovat do cenných papírů.</p>
ODDÍL 2 - KLÍČOVÉ INFORMACE O EMITENTOVĚ		
2.1	Kdo je emitentem cenných papírů?	
2.1.1	Informace o emitentovi	
		<p>a) Právní a obchodní název Emitenta je "AWEARE Global AG". Emitent je akciovou společností založenou v Lichtenštejnském knížectví a řídí se právem Lichtenštejnského knížectví. Emitent má sídlo ve Vaduzu, Lichtenštejnské knížectví, a je zapsán u Úřadu spravedlnosti / obchodního rejstříku Lichtenštejnského knížectví pod registračním číslem FL-0002.714.015-4.</p> <p>b) Účelem Emitenta je vyvíjet a zpeněžovat technologie senzorů a umělé inteligence pro autonomní vozidla a další aplikace.</p> <p>c) Hlavními akcionáři Emitenta jsou:</p> <ul style="list-style-type: none"><li>• Global Innovation Partners Limited, Britské Panenské ostrovy s většinovými akcionáři Dr. Danielem Hymanem, Maheshem Reddym, Dr. Reginaldem Tangem a Markem Hymanem.</li></ul> <p>d) Představenstvo Emitenta tvoří:</p> <ul style="list-style-type: none"><li>• Dr. Daniel Hyman, státní příslušnost: Hyman, Spojené státy americké, Poštovní adresa: Hyman, adresa: Long Beach, Kalifornie, USA</li><li>• Mahesh Reddy, státní příslušnost: Spojené státy, Poštovní adresa: Adresa: Irvine, Kalifornie, USA</li><li>• Marcel Füssinger, státní příslušnost: Rakousko, poštovní adresa: 160009, Singapur</li><li>• Revalier AG zastoupená Reinholdem Wohlwendem, státní příslušnost: Poštovní adresa: Lichtenštejnsko, adresa pro doručování: 9490, Vaduz, Lichtenštejnsko</li></ul> <p>e) Auditor je: Lucas Tihanyi, člen Lichtenštejnské asociace auditorů a EXPERTSuisse, Industriering 14, 9491 Ruggell, Lichtenstein</p>
2.2	Jaké jsou klíčové finanční informace o emitentovi?	

Emitent byl založen dne 30. 11. 2023 zápisem do obchodního rejstříku Lichtenštejnského knížectví. Podle prohlášení představenstva ze dne 25. 10. 2023 Emitent nepodléhá běžnému auditu a nepodléhá ani revizi. Roční účetní závěrka k 31. prosinci 2023 a mezitímní účetní závěrka k 15. červenci 2023 však byly auditorem ověřeny.

Následující klíčové finanční informace byly vypracovány v souladu s ustanoveními lichtenštejnského zákona o osobách a společnostech ("PCL"), zejména čl. 1024 a násl.

#### Výkaz zisku a ztráty

	31/12/2023	15/07/2024
<b>Celkové příjmy</b>	0 USD	0 USD
<b>Provozní zisk/ztráta</b>	USD -2'473,03	-30'150,54 USD
<b>Čistý zisk/ztráta</b>	USD -2'473,03	-30'150,54 USD

#### Rozvaha

	31/12/2023	15/07/2024
<b>Aktiva celkem</b>	50'184,35 USD	75'244,30 USD
<b>Vlastní kapitál celkem</b>	47 526,97 USD	19'849,46 USD
<b>Čistý finanční dluh (dlouhodobý dluh plus krátkodobý dluh minus hotovost)</b>	0 USD	0 USD

#### Výkaz peněžních toků

	31/12/2023	15/07/2024
<b>Příslušné čisté peněžní toky z provozní činnosti</b>	0 USD	0 USD
<b>Příslušné čisté Peněžní toky z investiční činnosti</b>	0 USD	0 USD
<b>Příslušné čisté Peněžní toky z finanční činnosti</b>	0 USD	0 USD

Výhled Emitenta se od mezitímní rozvahy k 15. 7. 2024 výrazně nezhoršil. Od data sestavení mezitímní rozvahy k 15/07/2024 nedošlo k žádným významným změnám ve finanční a obchodní situaci Emitenta.

2.2.1

#### 2.3 Jaká klíčová rizika jsou pro emitenta specifická?

##### Nízký kapitál

Účelem Emitenta je komercializace technologie AWEARE. Vlastní kapitál Emitenta je omezen na 50 000,00 USD, přičemž minimální kapitál požadovaný podle lichtenštejnského práva činí 50 000,00 USD. Vzhledem k tomu, že Emitent byl založen dne 30. 11. 2023, nejsou k dispozici žádné významné historické finanční údaje nebo klíčové hodnoty, kromě historických finančních informací uvedených v části 2.2.1 tohoto shrnutí, které by umožnily posoudit finanční situaci Emitenta ve vztahu k minulým letům. Emitent nepodléhá běžnému auditu a není u něj prováděn auditní přezkum. Emitent nebyl hodnocen ratingovou agenturou. Nízký vlastní kapitál představuje pro investora zvýšené riziko, protože funkce jako ručitelského kapitálu je odpovídajícím způsobem snížena.

2.3.1

##### Riziko platební neschopnosti

V případě zahájení insolvenčního řízení na majetek Emitenta bude Emitent dočasně nebo trvale omezen v nakládání se svým majetkem nebo nakládání s majetkem Emitenta převezme soudem jmenovaný insolvenční správce. To může mít negativní dopad na finanční situaci a obchodní činnost Emitenta. Tento případ může nastat i v případě, že insolvenční návrh byl podán nesprávně. V případě platební neschopnosti Emitenta nesou účastníci odpovědnost svým investovaným kapitálem. S investovaným kapitálem je třeba zacházet jako s vlastním kapitálem, a proto je kvalifikovaně podřízen.

	<p><b>Financování podnikání</b>  Minimální kapitál, který je třeba získat, není stanoven. Neexistuje žádná záruka umístění, ale spíše riziko, že globální tokeny AWEARE nebudou plně upsány (riziko umístění). Pokud se Emitentovi nepodaří získat požadovaný objem emise, bude moci investovat méně. Existuje riziko, že Emitentovi bude chybět kapitál. Kromě toho zůstanou zachovány emisní náklady, které jsou nezávislé na výši získaného kapitálu, což zvýší poměr nákladů k celkovému získanému investičnímu kapitálu. V takovém případě existuje riziko, že Emitent nedosáhne zamýšlených investičních cílů a nebude schopen plnit své závazky vyplývající z globálních tokenů AWEARE.</p> <p><b>Řízení, technologie, závislost na poskytovatelích služeb třetích stran, konkurence a časové rámce vývoje.</b>  Jednou z klíčových předností Emitenta je promyšlené využívání nejnovějších radarových technologií. Technické výhody v odvětví informačních a komunikačních technologií však mohou být krátkodobé. Úspěch Emise bude proto částečně záviset na schopnosti řídit a rozšiřovat služby Emitenta a zvyšovat uživatelskou základnu jeho podnikání, a tím generovat příjmy v reakci na měnící se technologie, požadavky uživatelů a poskytovatelů služeb třetích stran a konkurenční tlaky. Neúspěch nebo zpoždění v tomto směru může mít nepříznivý dopad na úspěch Emitenta.</p> <p><b>Lidská chyba u chytrých smluv</b>  Emitent nepřebírá žádnou odpovědnost a neposkytuje žádná prohlášení ani záruky ohledně funkčnosti projektu Emitenta nebo jakýchkoli inteligentních smluv, které mohou být naprogramovány nebo použity pro vypořádání nabídky v souladu s tímto Prospektem v nejšířším slova smyslu. Investoři mohou v důsledku toho utrpět znehodnocení nebo obecně čelit úplné ztrátě. V takových scénářích se však mohou uplatnit právní mechanismy na ochranu investora před ztrátou.</p>
<b>ODDÍL 3 - KLÍČOVÉ INFORMACE O CENNÝCH PAPIŘECH</b>	
3.1	Jaké jsou hlavní rysy cenných papírů?
3.1.1	Informace o cenných papírech
a)	<p><b>Popis druhu a třídy cenných papírů</b></p> <p>1 400 000 nových účastnických cenných papírů veřejně nabízených Emitentem jsou účastnické cenné papíry na doručitele bez hlasovacího práva, každý o jmenovité hodnotě <b>0,01 USD</b> účastnického kapitálu ("<b>Globální tokeny AWEARE</b>"), z nové emise účastnického kapitálu, o které rozhodla mimořádná valná hromada dne 18. 7. 2024. Držitelé globálních tokenů AWEARE se nazývají "<b>účastníci</b>" nebo "<b>držitelé tokenů</b>".</p>
b)	<p><b>Měna emise cenných papírů</b></p> <p>Americký dolar ("<b>USD</b>" nebo "<b>\$</b>"). Doba platnosti globálního tokenu AWEARE je neomezená.</p>
c)	<p><b>Popis práv spojených s cennými papíry</b></p> <p><b>Volební právo</b>  Globální tokeny AWEARE jsou nehlasovacími účastnickými certifikáty a neopravňují Účastníka k hlasování, svolání a účasti na valné hromadě Emitenta. Globální tokeny AWEARE dále nezakládají právo na nahlížení a právo podat žádost. Na Valné hromadě však lze podat písemnou žádost o informace, o nahlédnutí nebo o zahájení úředního auditu.</p> <p><b>Oznámení o svolání a usnesení valné hromady</b>  Účastníkům musí být oznámeno svolání valné hromady spolu s body programu a návrhy. Každé usnesení valné hromady musí být Účastníkům neprodleně zpřístupněno k nahlédnutí v sídle Emitenta. O tom musí být Účastníci informováni v oznámení.</p> <p><b>Nárok na dividendu a podíl na výnosech z likvidace</b>  Globální tokeny AWEARE nesou plná práva na dividendu od data platného nabytí a opravňují jejich držitele k podílu na likvidačním výnosu v poměru k jejich podílu na základním kapitálu. Emitent v současné době neplánuje v blízké budoucnosti vyplácet dividendy. Přestože nárok na dividendy podle stanov existuje, nejsou činěny žádné prognózy týkající se budoucí výplaty dividend. Emitent hodlá reinvestovat zisk do dalšího růstu a rozvoje společnosti.</p> <p><b>Forma a sekuritizace</b>  AWEARE Global Tokens budou vydávány jako tokeny. Tokeny jsou hodnotová práva, která se vydávají v decentralizované databázi (Blockchain) a tam se také převádějí. Blockchainem používaným pro tento účel je Ethereum Blockchain.</p> <p><b>Vyloučení práv na úpis a práv na účast</b>  Do dosažení cílové výše základního kapitálu 50 000 USD jsou přednostní práva podle článků 304d, 304f a 304g ZOK, zejména práva na upisování akcií a práva účastníků na účast, vyloučena.</p> <p><b>Převoditelnost cenných papírů</b>  Převod (např. převod v užším slova smyslu, zástava, dědictví) globálních tokenů AWEARE vyžaduje souhlas představenstva Emitenta. Převoditelnost je proto do určité míry omezena. V každém případě není převod Globálních tokenů AWEARE</p>

		povolen, pokud by je pak držela osoba v zemi, ve které Globální tokeny AWEARE nesmí být nabízeny. Za převod ve výše uvedeném smyslu se rovněž považuje, pokud Držitel Tokenů přesune své bydliště do země, ve které Globální Tokeny AWEARE nesmí být nabízeny.
d)	<b>Relativní nadřazenost cenných papírů v kapitálové struktuře emitenta v případě platební neschopnosti.</b>	V případě platební neschopnosti emitenta nesou účastníci odpovědnost svým investovaným kapitálem. S investovaným kapitálem se zachází jako s vlastním kapitálem, a proto je kvalifikovaně podřízen.
e)	<b>Popis dividendové politiky</b>	K dnešnímu dni nebyly vyplaceny žádné dividendy. Emitent neprovádí žádné prognózy ani odhady zisku, a proto se popis dividendové politiky neprovádí. Případné dividendy budou vypláceny v USD. Emitent si vyhrazuje právo vyplácet dividendy i v jiné měně nebo kryptoměně. Případné rozhodnutí o výplatě dividend bude přijato v souladu s platnými právními předpisy a bude mimo jiné záviset na výsledcích hospodaření Emitenta, jeho finanční situaci, smluvních omezeních a kapitálových požadavcích. V každém případě bude 5 % čistého zisku přiděleno do zákonných rezerv, dokud nedosáhne výše 10 % splaceného základního kapitálu.
<b>3.2</b>	<b>Kde se bude s cennými papíry obchodovat?</b>	
<b>3.2.1</b>	Tokeny AWEARE Global nejsou přijaty k obchodování na regulovaném trhu. Emitent si vyhrazuje právo požádat o přijetí k obchodování na regulovaném trhu.	
<b>3.4</b>	<b>Jaká jsou klíčová rizika, která jsou specifická pro cenné papíry?</b>	
<b>3.4.1</b>	<p><b>Riziko peněženky investorů a soukromých klíčů</b> Riziko výběru peněženky nebo umístění soukromého klíče nese pouze investor. V případě použití nekompatibilní peněženky nebo ztráty soukromého klíče je přístup ke globálním tokenům AWEARE obvykle nemožný. Důsledky, jako je například úplná ztráta investice, musí nést výhradně investor.</p> <p><b>Riziko prodejnosti, likvidity a realizace</b> Není jisté, že se pro tokeny AWEARE Global vytvoří likvidní trh. V důsledku toho by tokeny AWEARE Global nemohly být prodány na sekundárním trhu, což by pro investora představovalo riziko likvidity.</p> <p><b>Riziko volatility</b> Existují rizika spojená s volatilitou ceny akcií. Pokud by došlo k prodeji tokenů AWEARE Global a ty by se ocitly v prudkém výkyvu ceny směrem dolů, mohl by držitel tokenů v důsledku prodeje utrpět ztráty, z nichž některé by mohly být značné.</p> <p><b>Ztráta žetonů</b> Tokeny mohou být ztraceny nebo se mohou stát nedostupnými, zejména pokud držitel tokenu ztratí příslušný soukromý klíč k nakládání se svými globálními tokeny AWEARE nebo v důsledku poruchy elektronické peněženky, v níž jsou globální tokeny AWEARE uloženy. To by mohlo vést ke ztrátě Tokenů. Za bezpečné uložení a ochranu soukromého klíče, který umožňuje přístup k elektronické peněženke, odpovídají výhradně držitelé tokenů. Tokeny se mohou stát nedostupnými také v případě úmrtí držitele tokenů, pokud se pro tyto případy nepřipravil. Emitent ani jiný orgán či instituce nebudou schopny obnovit přístup k peněženke držitele tokenů pro jeho nástupce. Ztráta soukromých klíčů by dále mohla snížit dostupnost různých funkcí STO a globálních tokenů AWEARE. Zejména by mohlo být znemožněno vydávání Globálních tokenů AWEARE předplatitelům nebo jejich převoditelnost, v takovém případě by zůstaly pozastaveny na dobu neurčitou. Dále může být nemožné provádět výplaty dividend. V neposlední řadě existuje riziko, že útočník může razit tokeny AWEARE Global Tokens pro nepřispívající adresy, měnit stav potvrzení, přispívat nekontrolovanými částkami do STO nebo umožnit útočníkovi vybrat nevyzvednuté výplaty dividend.</p> <p><b>Omezená práva držitelů tokenů</b> Globální tokeny AWEARE jsou nehlasovacími účastnickými certifikáty a neopravňují držitele tokenů k hlasování, svolání a účasti na valné hromadě Emitenta. Globální tokeny AWEARE dále nezakládají právo na informace, právo na nahlížení a právo podat žádost. Valná hromada Emitenta proto může přijmout usnesení, která mohou mít nepříznivý dopad na práva Vlastníků tokenů. Držitelé tokenů nemají možnost kontrolovat využití výnosů z emise globálních tokenů AWEARE. Převod (např. převod v užším slova smyslu, zastavení, dědictví) globálních tokenů AWEARE vyžaduje souhlas představenstva Emitenta. V žádném případě není povolen převod Globálních tokenů AWEARE, pokud by je pak držela osoba v zemi, ve které Globální tokeny AWEARE nesmí být nabízeny. Za převod ve výše uvedeném smyslu se rovněž považuje, pokud Držitel Tokenů přesune své bydliště do země, ve které Globální Tokeny AWEARE nesmí být nabízeny. Zákonné právo Držitelů Tokenů na úpis v případě navýšení kapitálu v rámci této nabídky je vyloučeno.</p> <p><b>Pohledávky držitelů tokenů jsou podřízené</b> Právo držitelů tokenů požadovat a obdržet dividendy od Emitenta je podřízené pohledávkám všech držitelů nepodřízených závazků Emitenta. V případě likvidace Emitenta budou Majitelé tokenů vyplaceni pouze tehdy a poté, co budou vypořádány všechny nadřazené závazky Emitenta.</p>	

## ODDÍL 4 - KLÍČOVÉ INFORMACE O VEŘEJNÉ NABÍDCE CENNÝCH PAPIRŮ

### 4.1 Za jakých podmínek a v jakém časovém plánu mohu investovat do tohoto cenného papíru?

#### Země, ve kterých jsou cenné papíry nabízeny

Nabídka se skládá z veřejných nabídek v Rakousku, Belgii, Bulharsku, Chorvatsku, Kypru, České republice, Dánsku, Estonsku, Finsku, Francii, Německu, Řecku, Maďarsku, Islandu, Irsku, Itálii, Lotyšsku, Lichtenštejnsku, Litvě, Lucembursku, Maltě, Nizozemsku, Norsku, Polsku, Portugalsku, Rumunsku, Slovensku, Slovinsku, Španělsku, Švédsku a Švýcarsku, jakož i z neveřejných nabídek v některých jurisdikcích mimo tyto země.

#### Země, ve kterých nejsou cenné papíry nabízeny

Globální tokeny AWEARE Emitenta nejsou a nebudou registrovány podle ustanovení zákona o cenných papírech Spojených států amerických z roku 1933, ve znění pozdějších předpisů, ani u regulačních orgánů pro cenné papíry žádného státu Spojených států amerických, Austrálie, Japonska nebo Kanady. Nebudou proto přímo ani nepřímo nabízeny, prodávány ani dodávány veřejnosti, s výjimkou případů, kdy se na ně vztahuje výjimka z registračních požadavků. Tento Prospekt zejména nepředstavuje ani nezakládá nabídku k prodeji nebo výzvu k podání nabídky ke koupi globálních tokenů AWEARE ve Spojených státech amerických, Austrálii, Japonsku a Kanadě a nesmí být v nich distribuován. Kromě toho tento Prospekt nepředstavuje ani nezakládá nabídku k prodeji nebo výzvu k podání nabídky na koupi globálních tokenů AWEARE v Rusku, Íránu nebo Severní Koreji, Bělorusku, Sýrii nebo na jakémkoli jejich území. A nesmí být v nich distribuován.

#### Nabídka

Proces upisování globálních tokenů AWEARE bude probíhat online na [adrese https://kyc.awearetech.li/](https://kyc.awearetech.li/) ("Dashboard").

#### Nabídkové období

Období, během něhož mohou investoři předkládat své nabídky na koupi globálních tokenů AWEARE, začíná dnem schválení prospektu a končí o rok později ("období nabídky"). V poslední den Nabídkového období lze nabídky podávat do 12:00 lichtenštejnského času.

#### Nabídková cena

Nabídková cena jednoho tokenu AWEARE je **12,00 USD** (dále jen "nabídková cena").

Na podporu včasné investice jsou k dispozici následující slevy:

Při investici v rozmezí od 10 000 USDC do 49 999,99 USDC získají investoři slevu 10 %, takže cena za jeden token AWEARE bude 10,80 USD.

Při investici 50 000 USDC nebo více získají investoři slevu 15 %, takže cena za jeden token AWEARE bude 10,20 USD.

#### Dostupnost slev

Výše uvedené slevy jsou k dispozici, **dokud nenastane jedna z následujících skutečností, podle toho, která nastane dříve:**

- dosažení celkového objemu investic ve výši **5 000 000 USDC**, nebo
- uplynutí **tří měsíců od zahájení nabídky**.

#### Dodání a vypořádání

Každý investor musí dokončit proces online přihlášení k odběru na informačním panelu. Tokeny AWEARE Global budou přiděleny mimo řetězec jako záznam v databázi Emitenta, který je viditelný prostřednictvím Dashboardu, proti zaplacení Nabídkové ceny. Globální tokeny AWEARE budou přiděleny on-chain v inteligentní smlouvě nejpozději do dvou měsíců po skončení Nabídkového období. Jakmile skončí celková nabídka AWEARE Global Tokenů (po dosažení cílového participačního kapitálu) a Emitent rozhodne o finalizaci Smart Contractu, budou AWEARE Global Tokeny doručeny do kryptopeněženky investora.

#### Ředění

Vzhledem k tomu, že v případě navýšení kapitálu v rámci této nabídky je zákonné právo na úpis všech účastníků vyloučeno, nedojde k rozředění účastníků této nabídky.

#### Celkové čisté výnosy a odhadované náklady emise

Celkový čistý výtěžek z nabídky nad 1 400 000 globálních tokenů AWEARE může činit přibližně **15 000 000 USD**, což odpovídá realizaci navýšení prostředků. Předpokládané celkové náklady nabídky činí přibližně **1 500 000 USD** a budou hrazeny z výtěžku.

### 4.2 Proč se tento prospekt připravuje?

a) Odhadovaný čistý výnos z emise cenných papírů bude použit především na výzkum a vývoj a ochranu duševního vlastnictví. V případě potřeby může být nutné přesunout až 50 % přiděleného rozpočtu na jinou položku.

#### 4.2.1

- 10 % nákladů na navýšení
- 11 % Obecné a administrativní činnosti
- 41 % Výzkum a vývoj
- 17 % Právní záležitosti (globální ochrana duševního vlastnictví)

	<p>v) 21% Rozvoj autobusové dopravy, prodej a marketing</p> <p>b) Mezi současné akcionáře společností AWEARE Technologies Inc. a Global Innovation Partners Limited patří Mahesh Reddy a Dr. Daniel Hyman. Mahesh Reddy a Dr. Daniel Hyman jsou rovněž řediteli a menšinovými akcionáři Emitenta.</p> <p>c) Společnost Equanimity AG dostává transakční poplatek ve výši 3 % z celkového objemu naběhlých kryptoměn a fiat plateb. Marcel Füssinger, který je jedním z ředitelů Emitenta, je rovněž ředitelem a vlastníkem společnosti Equanimity AG.</p> <p>d) <b>Celkové čisté výnosy a odhadované náklady emise</b> Celkový čistý výtěžek z nabídky nad 1 400 000 globálních tokenů AWEARE může činit přibližně <b>15 000 000 USD</b>, což odpovídá realizaci navýšení prostředků. Předpokládané celkové náklady nabídky činí přibližně <b>1 500 000 USD</b> a budou hrazeny z výtěžku.</p> <p>e) <b>Upisovací ujednání</b> Nabídka nepodléhá závazné dohodě o úpisu. Neexistuje žádná smlouva, na jejímž základě by byl upisovatel povinen upsat neprodané tokeny. Proto neexistuje žádná záruka, že bude umístěna celá nabídka.</p>
--	--

## IX. SAMENVATTING VAN HET PROSPECTUS

Deze samenvatting bevat alle elementen die in een samenvatting voor dit type effecten en uitgevende instelling moeten worden opgenomen.

DEEL 1 - INLEIDING		
1.1	Naam en ISIN van de effecten	De <b>1.400.000</b> nieuwe participatiebewijzen zijn niet-stemgerechtigde participatiebewijzen aan toonder van AWEARE Global AG. De naam van deze participatiebewijzen is " <b>AWEARE Global Tokens</b> ". De ISIN is LI1363014385.
1.2	Identiteit en contactgegevens van de uitgevende instelling, met inbegrip van haar identificatiecode voor rechtspersonen (LEI)	<b>AWEARE Global AG</b> (de "Emittent") c/o Revalier Aktiengesellschaft Pradafant 11, 9490 Vaduz, Vorstendom Tel: +423 237 63 47 E-mail: <a href="mailto:info@awearetech.li">info@awearetech.li</a> De LEI is: 391200PTNEZNXGJW1C39
1.3	Bevoegde autoriteit	<b>Autoriteit Financiële Markten</b> (de "FMA") Landstrasse 109, 9490 Vaduz, Vorstendom Liechtenstein Tel: +423 236 73 73 Fax: +423 236 73 74 E-mail: <a href="mailto:info@fma-li.li">info@fma-li.li</a>
1.4	Datum van goedkeuring van het prospectus	05/12/2024
1.5	Waarschuwingen	
1.5.1	<p>a) De samenvatting moet worden gelezen als een inleiding op dit Prospectus. Elke beslissing om in de effecten te beleggen moet door de belegger worden gebaseerd op de beschouwing van het Prospectus in zijn geheel.</p> <p>b) De belegger kan het geïnvesteerde kapitaal geheel of gedeeltelijk verliezen.</p> <p>c) Wanneer een vordering met betrekking tot informatie in het prospectus voor de rechter wordt gebracht, is het mogelijk dat de belegger die als eiser optreedt, krachtens de nationale wetgeving de kosten voor de vertaling van het prospectus moet dragen voordat de gerechtelijke procedure wordt gestart.</p> <p>d) De wettelijke aansprakelijkheid geldt enkel voor de personen die de samenvatting, met inbegrip van een vertaling ervan, hebben ingediend, maar enkel indien de samenvatting misleidend, onnauwkeurig of inconsistent is wanneer ze samen met de andere delen van het Prospectus wordt gelezen, of indien ze, wanneer ze samen met de andere delen van het Prospectus wordt gelezen, geen essentiële informatie bevat om beleggers te helpen wanneer ze overwegen om in de effecten te beleggen.</p>	
AFDELING 2 - KERNGEGEVENS OVER DE UITGEVENDE INSTELLING		
2.1	Wie is de emittent van de effecten?	



2.1.1	<b>Informatie over de uitgevende instelling</b>																																	
	<p>a) De wettelijke en commerciële naam van de Emittent is "AWEARE Global AG". De Emittent is een naamloze vennootschap opgericht in het Vorstendom Liechtenstein en valt onder de wetten van het Vorstendom Liechtenstein. De Emittent heeft haar statutaire zetel in Vaduz, Vorstendom Liechtenstein en is geregistreerd bij het Bureau van Justitie / Handelsregister van het Vorstendom Liechtenstein onder registratienummer FL-0002.714.015-4.</p> <p>b) Het doel van de Emittent is het ontwikkelen en te gelde maken van sensortechnologieën en kunstmatige intelligentie voor autonome voertuigen en andere toepassingen.</p> <p>c) De belangrijkste aandeelhouders van de Emittent zijn:</p> <ul style="list-style-type: none"> <li>• Global Innovation Partners Limited, Britse Maagdeneilanden met meerderheidsaandeelhouders Dr. Daniel Hyman, Mahesh Reddy, Dr. Reginald Tang en Mark Hyman.</li> </ul> <p>d) De Raad van Bestuur van de Emittent bestaat uit:</p> <ul style="list-style-type: none"> <li>• Dr. Daniel Hyman, Nationaliteit: Verenigde Staten, Postadres: Long Beach, Californië, VS</li> <li>• Mahesh Reddy, Nationaliteit: Verenigde Staten, Postadres: Irvine, Californië, Verenigde Staten</li> <li>• Marcel Füssinger, Nationaliteit: Oostenrijk, Postadres: 160009, Singapore</li> <li>• Revalier AG vertegenwoordigd door Reinhold Wohlwend, Nationaliteit: Liechtenstein, Postadres: 9490, Vaduz, Liechtenstein</li> </ul> <p>e) De accountant is: Lucas Tihanyi, lid van de Liechtensteinse vereniging van accountants en EXPERTsuisse, Industriering 14, 9491 Ruggell, Liechtenstein.</p>																																	
2.2	<b>Wat is de belangrijkste financiële informatie over de uitgevende instelling?</b>																																	
2.2.1	<p>De Emittent werd opgericht op 30/11/2023 door inschrijving in het handelsregister van het Vorstendom Liechtenstein. Volgens de verklaring van de Raad van Bestuur van 25 oktober 2023 is de Emittent niet onderworpen aan een gewone audit en is zij niet onderworpen aan een auditbeoordeling. De jaarrekening per 31 december 2023 en de tussentijdse jaarrekening per 15 juli 2023 werden echter gecontroleerd door de Commissaris.</p> <p>De volgende essentiële financiële informatie is opgesteld in overeenstemming met de bepalingen van de Liechtensteinse Personen- en Vennootschapswet, in het bijzonder Art. 1024 en volgende.</p> <p style="text-align: center;"><b>Resultatenrekening</b></p> <table border="1" style="margin-left: auto; margin-right: auto;"> <thead> <tr> <th></th> <th style="text-align: center;">31/12/2023</th> <th style="text-align: center;">15/07/2024</th> </tr> </thead> <tbody> <tr> <td><b>Totale inkomsten</b></td> <td style="text-align: center;">USD 0</td> <td style="text-align: center;">USD 0</td> </tr> <tr> <td><b>Bedrijfswinst/verlies</b></td> <td style="text-align: center;">USD -2'473.03</td> <td style="text-align: center;">USD -30'150,54</td> </tr> <tr> <td><b>Nettowinst/-verlies</b></td> <td style="text-align: center;">USD -2'473.03</td> <td style="text-align: center;">USD -30'150,54</td> </tr> </tbody> </table> <p style="text-align: center;"><b>Balans</b></p> <table border="1" style="margin-left: auto; margin-right: auto;"> <thead> <tr> <th></th> <th style="text-align: center;">31/12/2023</th> <th style="text-align: center;">15/07/2024</th> </tr> </thead> <tbody> <tr> <td><b>Totaal activa</b></td> <td style="text-align: center;">USD 50'184.35</td> <td style="text-align: center;">USD 75'244.30</td> </tr> <tr> <td><b>Totaal eigen vermogen</b></td> <td style="text-align: center;">USD 47.526,97</td> <td style="text-align: center;">USD 19.849,46</td> </tr> <tr> <td><b>Netto financiële schuld (lange termijn schuld plus korte termijn schuld min liquide middelen)</b></td> <td style="text-align: center;">USD 0</td> <td style="text-align: center;">USD 0</td> </tr> </tbody> </table> <p style="text-align: center;"><b>Kasstroomoverzicht</b></p> <table border="1" style="margin-left: auto; margin-right: auto;"> <thead> <tr> <th></th> <th style="text-align: center;">31/12/2023</th> <th style="text-align: center;">15/07/2024</th> </tr> </thead> <tbody> <tr> <td><b>Relevante nettokasstromen uit bedrijfsactiviteiten</b></td> <td style="text-align: center;">USD 0</td> <td style="text-align: center;">USD 0</td> </tr> <tr> <td><b>Relevante nettokasstromen uit investeringsactiviteiten</b></td> <td style="text-align: center;">USD 0</td> <td style="text-align: center;">USD 0</td> </tr> </tbody> </table>		31/12/2023	15/07/2024	<b>Totale inkomsten</b>	USD 0	USD 0	<b>Bedrijfswinst/verlies</b>	USD -2'473.03	USD -30'150,54	<b>Nettowinst/-verlies</b>	USD -2'473.03	USD -30'150,54		31/12/2023	15/07/2024	<b>Totaal activa</b>	USD 50'184.35	USD 75'244.30	<b>Totaal eigen vermogen</b>	USD 47.526,97	USD 19.849,46	<b>Netto financiële schuld (lange termijn schuld plus korte termijn schuld min liquide middelen)</b>	USD 0	USD 0		31/12/2023	15/07/2024	<b>Relevante nettokasstromen uit bedrijfsactiviteiten</b>	USD 0	USD 0	<b>Relevante nettokasstromen uit investeringsactiviteiten</b>	USD 0	USD 0
	31/12/2023	15/07/2024																																
<b>Totale inkomsten</b>	USD 0	USD 0																																
<b>Bedrijfswinst/verlies</b>	USD -2'473.03	USD -30'150,54																																
<b>Nettowinst/-verlies</b>	USD -2'473.03	USD -30'150,54																																
	31/12/2023	15/07/2024																																
<b>Totaal activa</b>	USD 50'184.35	USD 75'244.30																																
<b>Totaal eigen vermogen</b>	USD 47.526,97	USD 19.849,46																																
<b>Netto financiële schuld (lange termijn schuld plus korte termijn schuld min liquide middelen)</b>	USD 0	USD 0																																
	31/12/2023	15/07/2024																																
<b>Relevante nettokasstromen uit bedrijfsactiviteiten</b>	USD 0	USD 0																																
<b>Relevante nettokasstromen uit investeringsactiviteiten</b>	USD 0	USD 0																																

	<table border="1"> <tr> <td><b>Relevante nettokasstromen uit financieringsactiviteiten</b></td> <td>USD 0</td> <td>USD 0</td> </tr> </table> <p>De vooruitzichten van de Emittent zijn niet aanzienlijk verslechterd sinds de tussentijdse balansdatum per 15/07/2024. Er hebben zich geen belangrijke wijzigingen voorgedaan in de financiële positie of handelspositie van de Emittent sinds de verslagdatum van de tussentijdse balans per 15/07/2024.</p>	<b>Relevante nettokasstromen uit financieringsactiviteiten</b>	USD 0	USD 0
<b>Relevante nettokasstromen uit financieringsactiviteiten</b>	USD 0	USD 0		
<b>2.3</b>	<b>Wat zijn de belangrijkste risico's die specifiek zijn voor de uitgevende instelling?</b>			
<b>2.3.1</b>	<p><b>Laag kapitaal</b> Het doel van de Emittent is de commercialisering van de technologie van AWEARE. Het aandelenkapitaal van de Emittent is beperkt tot USD 50.000,00, waarbij het minimumkapitaal vereist door de Liechtensteinse wet USD 50.000,00 bedraagt. Aangezien de Emittent werd opgericht op 30/11/2023, zijn er geen belangrijke historische financiële gegevens of kerncijfers beschikbaar, behalve de historische financiële informatie waarnaar wordt verwezen in sectie 2.2.1 van deze samenvatting, om de financiële situatie van de Emittent met betrekking tot de voorbije jaren te beoordelen. De Emittent is niet onderworpen aan een gewone audit en heeft geen auditbeoordeling. De Emittent is niet geëvalueerd door een ratingbureau. Een laag eigen vermogen vertegenwoordigt een verhoogd risico voor de belegger, aangezien de functie als aansprakelijk vermogen dienovereenkomstig wordt verminderd.</p> <p><b>Insolventierisico</b> In geval van de opening van een insolventieprocedure over de activa van de Emittent, zal de Emittent tijdelijk of permanent beperkt worden in de vervreemding van zijn activa, of zullen vervreemdingen van activa van de Emittent worden overgenomen door een door de rechtbank aangestelde curator. Dit kan een negatieve impact hebben op de financiële positie en de bedrijfsactiviteiten van de Emittent. Dit geval kan zich zelfs voordoen als de insolventieaanvraag niet correct werd ingediend. In geval van insolventie van de Emittent zijn de Deelnemers aansprakelijk met hun belegd kapitaal. Het geïnvesteerde kapitaal moet worden behandeld als eigen vermogen en is daarom gekwalificeerd achtergesteld.</p> <p><b>Bedrijfsfinanciering</b> Er is geen minimumkapitaal dat moet worden opgehaald. Er is geen plaatsingsgarantie, maar eerder het risico dat de AWEARE Global Tokens niet volledig zullen worden onderschreven (plaatsingsrisico). Als de Emittent er niet in slaagt om het gewenste uitgiftevolume te werven, zal de Emittent minder kunnen investeren. Er bestaat een risico op een kapitaaltekort voor de Emittent. Bovendien zullen de emissiekosten, die onafhankelijk zijn van het opgehaalde kapitaalbedrag, blijven bestaan, wat de kostenratio zal verhogen in verhouding tot het totale opgehaalde investeringskapitaal. Het risico bestaat dat de Emittent in dit geval haar beoogde investeringsdoelstellingen niet zal bereiken en niet in staat zal zijn om haar verplichtingen onder de AWEARE Global Tokens na te komen.</p> <p><b>Management, technologie, afhankelijkheid van externe dienstverleners, concurrentie en ontwikkelingstermijnen</b> Een van de belangrijkste sterke punten van de Emittent is zijn scherpzinnig gebruik van de recentste radartechnologie. Technische voordelen in de sector van de informatie- en communicatietechnologie kunnen echter van korte duur zijn. Dienovereenkomstig zal het succes van de Emittent gedeeltelijk afhangen van zijn vermogen om de diensten van de Emittent te beheren en uit te breiden en om de gebruikersbasis van zijn bedrijf te laten groeien en bijgevolg inkomsten te genereren als antwoord op veranderende technologieën, de vraag van gebruikers en derde partij service providers en concurrentiedruk. Als de Emittent hierin niet slaagt of vertraging oploopt, kan dit een nadelige invloed hebben op zijn succes.</p> <p><b>Menselijke fouten met slimme contracten</b> De Emittent aanvaardt geen aansprakelijkheid en geeft geen verklaringen of garanties met betrekking tot de functionaliteit van het project van de Emittent of van enige slimme contracten die kunnen worden geprogrammeerd of gebruikt voor de afwikkeling van het aanbod in overeenstemming met dit Prospectus in de ruimste zin van het woord. Beleggers kunnen hierdoor waardeverminderingen lijden of in het algemeen met een totaal verlies worden geconfronteerd. In dergelijke scenario's kunnen echter wettelijke mechanismen van toepassing zijn om een belegger tegen verlies te beschermen.</p>			
<b>DEEL 3 - KERNGEGEVENS OVER DE EFFECTEN</b>				
<b>3.1</b>	<b>Wat zijn de belangrijkste kenmerken van de effecten?</b>			
<b>3.1.1</b>	<b>Informatie over de effecten</b>			
<b>a)</b>	<p><b>Beschrijving van het type en de klasse van de effecten</b></p> <p>De <b>1.400.000</b> nieuwe participatiebewijzen die openbaar worden aangeboden door de Emittent zijn participatiebewijzen zonder stemrecht aan toonder, elk met een nominale waarde van <b>USD0,01</b> van het participatiekapitaal (de "<b>AWEARE Global Tokens</b>")., afkomstig van een nieuwe uitgifte van participatiekapitaal waartoe is besloten door een buitengewone Algemene Vergadering op 18/07/2024. Houders van AWEARE Global Tokens worden "<b>Deelnemers</b>" of "<b>Tokenhouders</b>" genoemd.</p>			

b)	<b>Valuta van de effectenemissie</b>	Amerikaanse Dollar ("USD" of "\$"). De looptijd van de AWEARE Global Token is onbeperkt.
c)	<b>Beschrijving van de rechten die aan de effecten verbonden zijn</b>	<p><b>Kiesrecht</b> AWEARE Global Tokens zijn deelnamebewijzen zonder stemrecht en geven de Deelnemer niet het recht om te stemmen op, het bijeenroepen van, en het deelnemen aan de Algemene Vergadering van de Emittent. Verder geven AWEARE Global Tokens geen recht op informatie, het recht op inzage en het recht om een aanvraag in te dienen. Er kan echter wel een schriftelijk verzoek om informatie of inspectie of voor het initiëren van een officiële controle worden ingediend bij de Algemene Vergadering.</p> <p><b>Aankondiging van de bijeenroeping en besluiten van de Algemene Vergadering</b> Deelnemers moeten op de hoogte worden gebracht van de bijeenroeping van de Algemene Vergadering samen met de agendapunten en de moties. Elk besluit van de Algemene Vergadering moet onverwijld op de maatschappelijke zetel van de Emittent ter inzage van de Deelnemers worden gelegd. De Deelnemers worden hiervan op de hoogte gesteld in de oproeping.</p> <p><b>Dividendrecht en aandeel in de liquidatieopbrengst</b> AWEARE Global Tokens hebben volledige dividendrechten vanaf de datum van geldige verwerving en geven hun houders recht op een deel van de liquidatieopbrengst in verhouding tot hun participatie in het participatiekapitaal. De Emittent is momenteel niet van plan om in de nabije toekomst dividenden uit te keren. Hoewel er volgens de statuten een recht op dividenden bestaat, worden er geen voorspellingen gedaan over toekomstige dividenduitkeringen. De Emittent heeft de intentie om winsten te herinvesteren in de verdere groei en ontwikkeling van het bedrijf.</p> <p><b>Vorm en securitisatie</b> AWEARE Global Tokens zullen worden uitgegeven als tokens. Tokens zijn waarderechten die worden uitgegeven op een gedecentraliseerde database (Blockchain) en daar worden overgedragen. De Blockchain die hiervoor wordt gebruikt is de Ethereum Blockchain.</p> <p><b>Uitsluiting van inschrijvingsrechten en participatierechten</b> Totdat het doelparticipatiekapitaal van USD 50.000 is bereikt, zijn de voorkeursrechten volgens de artikelen 304d, 304f en 304g PCL, in het bijzonder inschrijvingsrechten en participatierechten van de deelnemers, uitgesloten.</p> <p><b>Overdraagbaarheid van de effecten</b> De overdracht (zoals overdracht in enge zin, verpanding, vererving) van AWEARE Global Tokens vereist de goedkeuring van de Raad van Bestuur van de Emittent. De overdraagbaarheid is daarom tot op zekere hoogte beperkt. In ieder geval is een overdracht van AWEARE Global Tokens niet toegestaan indien deze dan in handen zouden komen van een persoon in een land waarin AWEARE Global Tokens niet mogen worden aangeboden. Een overdracht in bovenstaande zin wordt ook geacht plaats te vinden indien een Tokenhouder zijn woonplaats verplaatst naar een land waarin AWEARE Global Tokens niet mogen worden aangeboden.</p>
d)	<b>Relatieve voorrang van de effecten in de kapitaalstructuur van de emittent in geval van insolventie</b>	In geval van insolventie van de Emittent zijn de Deelnemers aansprakelijk met hun geïnvesteerde kapitaal. Het geïnvesteerde kapitaal moet worden behandeld als eigen vermogen en is daarom gekwalificeerd achtergesteld.
e)	<b>Beschrijving van het dividendbeleid</b>	Tot op heden zijn er geen dividenden betaald. De Emittent maakt geen winstprognoses of -ramingen en daarom wordt er geen beschrijving van het dividendbeleid gemaakt. Eventuele dividenden zullen worden betaald in USD. De Emittent behoudt zich het recht voor om dividenden ook in een andere valuta of cryptocurrency te betalen. Elk besluit om dividenden te betalen zal worden genomen in overeenstemming met de toepasselijke wetgeving en zal onder andere afhangen van de bedrijfsresultaten, financiële positie, contractuele beperkingen en kapitaalvereisten van de Emittent. In elk geval zal 5% van de nettowinst worden toegewezen aan de wettelijke reserves totdat dit het bedrag van 10% van het volgestorte aandelenkapitaal heeft bereikt.
<b>3.2</b>	<b>Waar zullen de effecten worden verhandeld?</b>	
<b>3.2.1</b>	AWEARE Global Tokens zijn niet toegelaten tot de handel op een gereguleerde markt. De Emittent behoudt zich het recht voor om toelating tot de handel op een gereguleerde markt aan te vragen.	

3.4	<b>Wat zijn de belangrijkste risico's die specifiek zijn voor de effecten?</b>
3.4.1	<p><b>Risico van beleggersportemonnee en privésleutel</b> Alleen de investeerder draagt het risico van de keuze van de wallet of de locatie van de privésleutel. Als een incompatibele wallet wordt gebruikt of als de private sleutel verloren gaat, is toegang tot de AWEARE Global Tokens normaal gesproken onmogelijk. De gevolgen, zoals het totale verlies van de investering, moeten uitsluitend door de investeerder worden gedragen.</p> <p><b>Risico van verkoopbaarheid, liquiditeit en realisatie</b> Er is geen zekerheid dat zich een liquide markt zal ontwikkelen voor de AWEARE Global Tokens. Als gevolg daarvan zouden AWEARE Global Tokens niet kunnen worden verkocht op een secundaire markt, waardoor een liquiditeitsrisico voor de belegger ontstaat.</p> <p><b>Volatiliteitsrisico</b> Er zijn risico's verbonden aan de volatiliteit van de aandelenkoers. Als AWEARE Global Tokens zouden worden verkocht en zij in een sterke neerwaartse koersschommeling terecht zouden komen, zou de Tokenhouder verliezen kunnen lijden, waarvan sommige aanzienlijk zouden kunnen zijn, als gevolg van de verkoop.</p> <p><b>Verlies van tokens</b> Tokens kunnen verloren gaan of ontoegankelijk worden, in het bijzonder indien de Tokenhouder de respectieve privésleutel verliest om over zijn AWEARE Global Tokens te beschikken of als gevolg van een storing in de e-wallet waarin de AWEARE Global Tokens zijn opgeslagen. Dit kan resulteren in het verlies van Tokens. Het is uitsluitend de verantwoordelijkheid van de Tokenhouders om de privésleutel die toegang geeft tot de e-wallet veilig op te slaan en te beschermen. Tokens kunnen ook ontoegankelijk worden in geval van overlijden van een Tokenhouder indien hij of zij geen voorzieningen heeft getroffen voor dergelijke gevallen. Noch de Emittent, noch enige andere instantie of instelling zal in staat zijn om de toegang tot de portemonnee van de Tokenhouder te herstellen voor de opvolgers van de Tokenhouder. Het verlies van privésleutels zou bovendien de beschikbaarheid van verschillende functionaliteiten van de STO en de AWEARE Global Tokens kunnen verminderen. In het bijzonder kan het onmogelijk zijn om AWEARE Global Tokens uit te geven aan abonnees of om ze overdraagbaar te maken, in welk geval ze voor onbepaalde tijd gepauzeerd zouden blijven. Bovendien kan het onmogelijk zijn om dividendbetalingen te doen. Ten slotte bestaat er een risico dat een aanvaller AWEARE Global Tokens kan slaan voor niet-contribuerende adressen, de bevestigingsstatus kan wijzigen, ongecontroleerde bedragen kan bijdragen aan de STO of de aanvaller in staat kan stellen niet-opgeëiste dividendbetalingen op te nemen.</p> <p><b>Beperkte rechten van Tokenhouder</b> AWEARE Global Tokens zijn participatiebewijzen zonder stemrecht en geven de Tokenhouders niet het recht om te stemmen op, het bijeenroepen van, en het deelnemen aan de Algemene Vergadering van de Emittent. Verder geven AWEARE Global Tokens geen recht op informatie, het recht op inzage en het recht om een aanvraag in te dienen. De Algemene Vergadering van de Emittent kan daarom besluiten nemen die een negatieve invloed kunnen hebben op de rechten van de Tokenhouders. Tokenhouders hebben geen mogelijkheid om het gebruik van de opbrengsten van de uitgifte van AWEARE Global Tokens te controleren. De overdracht (zoals overdracht in enge zin, verpanding, vererving) van AWEARE Global Tokens vereist de goedkeuring van de Raad van Bestuur van de Emittent. In ieder geval is een overdracht van AWEARE Global Tokens niet toegestaan indien deze dan zouden worden gehouden door een persoon in een land waarin AWEARE Global Tokens niet mogen worden aangeboden. Een overdracht in bovenstaande zin wordt ook geacht plaats te vinden indien een Tokenhouder zijn woonplaats verplaatst naar een land waarin AWEARE Global Tokens niet mogen worden aangeboden. Het wettelijke inschrijvingsrecht van de Tokenhouders in geval van een kapitaalverhoging onder dit aanbod is uitgesloten.</p> <p><b>De vorderingen van de Aandeelhouders zijn achtergesteld</b> De rechten van de Aandeelhouders om dividendbetalingen van de Emittent te vorderen en te ontvangen zijn achtergesteld bij de vorderingen van alle houders van niet-achtergestelde verplichtingen van de Emittent. In een vereffening van de Emittent zullen de Tokenhouders slechts worden betaald indien en nadat alle niet-achtergestelde verplichtingen van de Emittent zijn voldaan.</p>
<b>DEEL 4 - KERNGEGEVENS OVER DE AANBIEDING VAN EFFECTEN AAN HET PUBLIEK</b>	
4.1	<b>Onder welke voorwaarden en volgens welk tijdschema kan ik in dit effect investeren?</b>
<p><b>Landen waarin de effecten worden aangeboden</b> Het aanbod bestaat uit openbare biedingen in Oostenrijk, België, Bulgarije, Kroatië, Cyprus, Tsjechië, Denemarken, Estland, Finland, Frankrijk, Duitsland, Griekenland, Hongarije, IJsland, Ierland, Italië, Letland, Liechtenstein, Litouwen, Luxemburg, Malta, Nederland, Noorwegen, Polen, Portugal, Roemenië, Slowakije, Slovenië, Spanje, Zweden, Zwitserland evenals onderhandse plaatsingen in bepaalde rechtsgebieden daarbuiten.</p> <p><b>Landen waar de effecten niet worden aangeboden</b> AWEARE Global Tokens van de Emittent zijn niet en zullen niet worden geregistreerd onder de bepalingen van de United States Securities Act van 1933, zoals gewijzigd, of bij de effectenautoriteiten van enige staat van de Verenigde Staten van Amerika, of in Australië, Japan of Canada. Dienovereenkomstig zullen ze niet direct of indirect worden aangeboden, verkocht of geleverd aan het publiek, behalve krachtens een vrijstelling van de registratievereisten. In het bijzonder vormt dit Prospectus geen aanbod tot verkoop of uitnodiging tot het doen van een aanbod tot aankoop van AWEARE Global Tokens in de Verenigde Staten van Amerika, Australië, Japan en Canada en mag het daar niet worden verspreid. Daarnaast vormt dit</p>	

Prospectus geen aanbod tot verkoop of uitnodiging tot het doen van een aanbod tot aankoop van AWEARE Global Tokens in Rusland, Iran, of Noord-Korea, Wit-Rusland, Syrië, of enig gebied daarvan. En mag daar niet worden verspreid.

#### Bieden

Het inschrijvingsproces voor AWEARE Global Tokens zal online plaatsvinden op <https://kyc.awearetech.li/> (het "Dashboard").

#### Aanbodsperiode

De periode waarin beleggers hun aankoopaanbiedingen voor AWEARE Global Tokens kunnen indienen, begint op de datum van goedkeuring van het Prospectus en eindigt een jaar later (de "Aanbiedingsperiode"). Op de laatste dag van de Aanbiedingsperiode kunnen biedingen worden gedaan tot 12:00 uur 's middags Liechtensteinse tijd.

#### Biedprijs

De biedprijs van één AWEARE Token is **USD12,00** (de "Biedprijs").

Om vroege investeringen aan te moedigen, zijn de volgende kortingen beschikbaar:

Voor investeringen tussen 10.000 USDC en 49.999,99 USDC ontvangen investeerders een korting van 10%, waardoor de prijs per AWEARE Token USD10,80 wordt.

Voor investeringen van 50.000 USDC of meer ontvangen investeerders een korting van 15%, waardoor de prijs per AWEARE Token USD10,20 wordt.

#### Beschikbaarheid van kortingen

De bovenstaande kortingen zijn beschikbaar **tot een van de volgende situaties zich voordoet, afhankelijk van wat zich het eerst voordoet:**

- het bereiken van een totaal investeringsvolume van 5.000.000 USDC, of
- drie maanden na de start van de aanbidding.

#### Levering en afwikkeling

Elke investeerder moet het online inschrijvingsproces op het Dashboard voltooien. AWEARE Global Tokens zullen off-chain worden toegewezen als een record in de database van de Emittent, die zichtbaar is via het Dashboard, tegen betaling van de Biedprijs. AWEARE Global Tokens zullen uiterlijk binnen twee maanden na afloop van de Aanbiedingsperiode on-chain in het Smart Contract worden toegewezen. Zodra het totale aanbod van AWEARE Global Tokens (na het bereiken van het doelkapitaal voor deelname) is geëindigd en de Emittent heeft besloten om het Smart Contract af te ronden, zullen AWEARE Global Tokens worden geleverd aan de crypto wallet van de investeerder.

#### Verdunning

Aangezien het wettelijke inschrijvingsrecht van alle Deelnemers is uitgesloten in geval van een kapitaalverhoging in het kader van deze aanbidding, zullen de Deelnemers aan deze aanbidding niet verwateren.

#### Totale netto-opbrengst en geschatte uitgiftekosten

De totale netto-opbrengst van het aanbod van 1.400.000 AWEARE Global Tokens kan ongeveer **USD15.000.000** bedragen, wat overeenkomt met de implementatie van de fondsenverhoging. De verwachte totale kosten van het aanbod bedragen ongeveer **USD1.500.000** en zullen ten laste van de opbrengsten worden gebracht.

<b>4.2</b>	<b>Waarom wordt dit prospectus opgesteld?</b>
<b>4.2.1</b>	<p>a) De geschatte netto-opbrengst van de uitgifte van de effecten zal voornamelijk worden gebruikt voor onderzoek en ontwikkeling en IP-bescherming. Het kan nodig zijn om tot 50% van een toegewezen budget over te hevelen naar een andere functie als dat nodig is.</p> <ul style="list-style-type: none"><li>i) 10% Kosten van verhoging</li><li>ii) 11% Algemeen &amp; Administratief</li><li>iii) 41% Onderzoek &amp; Ontwikkeling</li><li>iv) 17% Juridisch (Wereldwijde IP-bescherming)</li><li>v) 21% Busontwikkeling, Verkoop &amp; Marketing</li></ul> <p>b) Tot de huidige aandeelhouders van AWEARE Technologies Inc. en Global Innovation Partners Limited behoren Mahesh Reddy en Dr. Daniel Hyman. Mahesh Reddy en Dr. Daniel Hyman zijn ook bestuurders en minderheidsaandeelhouders van de Emittent.</p> <p>c) Equanimity AG ontvangt een transactiefee van 3% van het totaal aan cryptovaluta en fiat betalingen. Marcel Füssinger, die een van de bestuurders van de Emittent is, is ook de bestuurder en eigenaar van Equanimity AG.</p> <p>d) <b>Totale netto-opbrengst en geschatte uitgiftekosten</b> De totale netto-opbrengst van het aanbod van 1.400.000 AWEARE Global Tokens kan ongeveer <b>USD15.000.000</b> bedragen, wat overeenkomt met de implementatie van de fondsenverhoging. De verwachte totale kosten van het aanbod bedragen ongeveer <b>USD1.500.000</b> en zullen ten laste van de opbrengsten worden gebracht.</p>

	e) <b>Overnameovereenkomsten</b> Het aanbod is niet onderworpen aan een vaste onderschrijvingsovereenkomst. Er is geen overeenkomst waaronder een underwriter verplicht is om onverkochte tokens te onderschrijven. Daarom is er geen garantie dat het volledige aanbod zal worden geplaatst.
--	--

## X. PROSPEKTI KOKKUVÕTE

Käesolev kokkuvõte sisaldab kõiki elemente, mis peavad sisalduma seda liiki väärtpaberite ja emitendi kokkuvõttes.

1. JAGU - SISSEJUHATUS		
1.1	Väärtpaberite nimi ja ISIN-kood	1 400 000 uut osalustunnistust on AWEARE Global AG hääleõiguseta osalustunnistused. Nende osalusertifikaatide nimi on "AWEARE Global Tokens". ISIN on LI1363014385.
1.2	Emitendi isiku- ja kontaktandmed, sealhulgas juriidilise isiku tunnus (LEI).	<b>AWEARE Global AG</b> (edaspidi "emitent") c/o Revalier Aktiengesellschaft Pradafant 11, 9490 Vaduz, Váduzi Vürstiriik Tel: +423 237 63 47 E-post: <a href="mailto:info@awearetech.li">info@awearetech.li</a> LEI on: 391200PTNEZNXCJW1C39
1.3	Pädev asutus	<b>Finantsturujärelevalve Asutus</b> (edaspidi "FMA") Landstrasse 109, 9490 Vaduz, Liechtensteini Vürstiriik Tel: +423 236 73 73 73 Faks: +423 236 73 74 E-post: <a href="mailto:info@fma-li.li">info@fma-li.li</a>
1.4	Prospekti kinnitamise kuupäev	05/12/2024
1.5	Hoiatused	
1.5.1	<p>a) Kokkuvõtet tuleks lugeda käesoleva prospekti sissejuhatusena. Investori otsus väärtpaberitesse investeerimise kohta peaks põhinema prospekti kui terviku läbivaatamisel.</p> <p>b) Investor võib kaotada kogu investeeritud kapitali või osa sellest.</p> <p>c) Kui prospektis sisalduva teabega seotud nõue esitatakse kohtusse, võib hageja investor siseriikliku õiguse kohaselt olla kohustatud kandma prospekti tõlkimise kulud enne kohtumenetluse algatamist.</p> <p>d) Tsiviilvastutus lasub ainult nendel isikutel, kes on esitanud kokkuvõtte, sealhulgas selle tõlke, kuid ainult juhul, kui kokkuvõtte on eksitav, ebatäpne või ebajärjekindel, kui seda loetakse koos prospekti muude osadega või kui see ei anna koos prospekti muude osadega lugedes olulist teavet, mis aitaks investoritel kaaluda, kas investeerida väärtpaberitesse.</p>	
2. JAGU - PÕHITEAVE EMITENDI KOHTA		
2.1	Kes on väärtpaberite emitent?	
2.1.1	Teave emitendi kohta	
	<p>a) Emitendi juriidiline ja ärinimi on "AWEARE Global AG". Emitent on Liechtensteini Vürstiriigis asutatud aktsiaselts, mida reguleerivad Liechtensteini Vürstiriigi seadused. Emitendi registrijärgne asukoht on Vaduzis, Liechtensteini Vürstiriigis ja ta on registreeritud Liechtensteini Vürstiriigi õigus- ja äriregistris registrinumbriga FL-0002.714.015-4.</p> <p>b) Emitendi eesmärk on arendada ja rahaliselt realiseerida sensoritehnoloogiaid ja tehisintellekti autonoomsete sõidukite ja muude rakenduste jaoks.</p> <p>c) Emitendi peamised aktsionärid on:</p> <ul style="list-style-type: none"> <li>• Global Innovation Partners Limited, Briti Neitsisaared, enamusaktsionärid Dr. Daniel Hyman, Mahesh Reddy, Dr. Reginald Tang ja Mark Hyman.</li> </ul> <p>d) Emitendi juhatusse kuuluvad:</p> <ul style="list-style-type: none"> <li>• Dr. Daniel Hyman, kodakondsus: Ameerika Ühendriigid, postiaadress: Long Beach, California, USA</li> <li>• Mahesh Reddy, kodakondsus: Ühendriikide, postiaadress: Irvine, California, USA</li> <li>• Marcel Füssinger, kodakondsus: Austria, postiaadress: 160009, Singapur</li> </ul>	

	<ul style="list-style-type: none"> <li>Revalier AG, esindaja: Reinhold Wohlwend, kodakondsus: Liechtenstein, postiaadress: 9490, Vaduz, Liechtenstein</li> </ul> <p>e) Auditor on: Lucas Tihanyi, Liechtensteini audiitorite ja EXPERTsuisse'i ühingu liige, Industriering 14, 9491 Ruggell, Liechtenstein.</p>																																				
<b>2.2</b>	<b>Milline on emitendi põhiline finantsteave?</b>																																				
<b>2.2.1</b>	<p>Emitent asutati 30.11.2023 Liechtensteini Vürstiriigi äriregistrisse kandmisega. Vastavalt juhatuse 25. oktoobri 2023. aasta deklaratsioonile ei kuulu emitent tavapärase auditeerimise ja auditi kontrolli alla. Siiski audiitor auditeeris 31. detsembri 2023. aasta raamatupidamise aastaaruannet ja vahearuanne 15. juuli 2023. aasta seisuga.</p> <p>Järgnev põhiline finantsteave on koostatud kooskõlas Liechtensteini isikute ja äriühingute seaduse (edaspidi "PCL") sätetega, eelkõige art. 1024 jj.</p> <p style="text-align: center;"><b>Kasumiaruanne</b></p> <table border="1" style="margin-left: auto; margin-right: auto;"> <thead> <tr> <th></th> <th style="text-align: center;">31/12/2023</th> <th style="text-align: center;">15/07/2024</th> </tr> </thead> <tbody> <tr> <td><b>Kogutulu</b></td> <td style="text-align: center;">USD 0</td> <td style="text-align: center;">USD 0</td> </tr> <tr> <td><b>Ärikasum/kahjum</b></td> <td style="text-align: center;">USD -2'473.03</td> <td style="text-align: center;">USD -30'150.54</td> </tr> <tr> <td><b>Puhaskasum/kahjum</b></td> <td style="text-align: center;">USD -2'473.03</td> <td style="text-align: center;">USD -30'150.54</td> </tr> </tbody> </table> <p style="text-align: center;"><b>Bilanss</b></p> <table border="1" style="margin-left: auto; margin-right: auto;"> <thead> <tr> <th></th> <th style="text-align: center;">31/12/2023</th> <th style="text-align: center;">15/07/2024</th> </tr> </thead> <tbody> <tr> <td><b>Varad kokku</b></td> <td style="text-align: center;">50'184,35 USD</td> <td style="text-align: center;">75'244,30 USD</td> </tr> <tr> <td><b>Omakapital kokku</b></td> <td style="text-align: center;">47,526.97 USD</td> <td style="text-align: center;">19'849,46 USD</td> </tr> <tr> <td><b>Neto finantsvõlg (pikaajaline võlg pluss lühiajaline võlg miinus sularaha)</b></td> <td style="text-align: center;">USD 0</td> <td style="text-align: center;">USD 0</td> </tr> </tbody> </table> <p style="text-align: center;"><b>Rahavoogude aruanne</b></p> <table border="1" style="margin-left: auto; margin-right: auto;"> <thead> <tr> <th></th> <th style="text-align: center;">31/12/2023</th> <th style="text-align: center;">15/07/2024</th> </tr> </thead> <tbody> <tr> <td><b>Asjakohane neto Rahavood äritegevusest</b></td> <td style="text-align: center;">USD 0</td> <td style="text-align: center;">USD 0</td> </tr> <tr> <td><b>Asjakohane neto Rahavood investeerimistegevusest</b></td> <td style="text-align: center;">USD 0</td> <td style="text-align: center;">USD 0</td> </tr> <tr> <td><b>Asjakohane neto Rahavood finantseerimistegevusest</b></td> <td style="text-align: center;">USD 0</td> <td style="text-align: center;">USD 0</td> </tr> </tbody> </table> <p>Emitendi väljavaated ei ole alates vahebilansipäevast 15/07/2024 oluliselt halvenenud. Emitendi finantsseisundis või kauplemisspositsioonis ei ole pärast 15/07/2024. aasta vahebilansi aruandekuupäeva olulisi muutusi toimunud.</p>		31/12/2023	15/07/2024	<b>Kogutulu</b>	USD 0	USD 0	<b>Ärikasum/kahjum</b>	USD -2'473.03	USD -30'150.54	<b>Puhaskasum/kahjum</b>	USD -2'473.03	USD -30'150.54		31/12/2023	15/07/2024	<b>Varad kokku</b>	50'184,35 USD	75'244,30 USD	<b>Omakapital kokku</b>	47,526.97 USD	19'849,46 USD	<b>Neto finantsvõlg (pikaajaline võlg pluss lühiajaline võlg miinus sularaha)</b>	USD 0	USD 0		31/12/2023	15/07/2024	<b>Asjakohane neto Rahavood äritegevusest</b>	USD 0	USD 0	<b>Asjakohane neto Rahavood investeerimistegevusest</b>	USD 0	USD 0	<b>Asjakohane neto Rahavood finantseerimistegevusest</b>	USD 0	USD 0
	31/12/2023	15/07/2024																																			
<b>Kogutulu</b>	USD 0	USD 0																																			
<b>Ärikasum/kahjum</b>	USD -2'473.03	USD -30'150.54																																			
<b>Puhaskasum/kahjum</b>	USD -2'473.03	USD -30'150.54																																			
	31/12/2023	15/07/2024																																			
<b>Varad kokku</b>	50'184,35 USD	75'244,30 USD																																			
<b>Omakapital kokku</b>	47,526.97 USD	19'849,46 USD																																			
<b>Neto finantsvõlg (pikaajaline võlg pluss lühiajaline võlg miinus sularaha)</b>	USD 0	USD 0																																			
	31/12/2023	15/07/2024																																			
<b>Asjakohane neto Rahavood äritegevusest</b>	USD 0	USD 0																																			
<b>Asjakohane neto Rahavood investeerimistegevusest</b>	USD 0	USD 0																																			
<b>Asjakohane neto Rahavood finantseerimistegevusest</b>	USD 0	USD 0																																			
<b>2.3</b>	<b>Millised on emitendile omased peamised riskid?</b>																																				
<b>2.3.1</b>	<p><b>Madal kapital</b></p> <p>Emitendi eesmärk on AWEARE tehnoloogia kommertsialiseerimine. Emitendi omakapital on piiratud 50 000,00 USA dollariga, kusjuures Liechtensteini seaduste kohaselt nõutav miinimumkapital on 50 000,00 USA dollarit. Kuna emitent asutati 30.11.2023, puuduvad olulised varasemad finantsandmed või põhinäitajad, välja arvatud käesoleva kokkuvõtte punktis 2.2.1 osutatud varasemad finantsandmed, et hinnata emitendi finantsseisundit seoses eelmiste aastatega. Emitendi suhtes ei teostata tavapärasest auditeerimist ja tal puudub audiitorikontroll. Emitenti ei ole hinnanud reitinguagentuur. Madal omakapital kujutab endast investori jaoks suuremat riski, kuna vastutusrikkaks kapitaliks olemise funktsioon on vastavalt vähenenud.</p>																																				

	<p><b>Maksejõuetuse risk</b> Kui emitendi varade suhtes algatatakse maksejõuetusmenetlus, piiratakse emitendi varade käsutamist ajutiselt või alaliselt või võtab emitendi varade käsutamise üle kohtu määratud pankrotihaldur. See võib avaldada negatiivset mõju emitendi finantsseisundile ja äritegevusele. See juhtum võib juhtuda isegi siis, kui maksejõuetuse taotlused on esitatud ebaõigesti. Emitendi maksejõuetuse korral vastutavad osalejad oma investeeritud kapitaliga. Investeeritud kapitali tuleb käsitleda omakapitalina ja see on seega kvalifitseeritult allutatud.</p> <p><b>Ettevõtete rahastamine</b> Minimaalset kapitali ei ole vaja kaasata. Pigem on oht, et AWEARE Global Tokenid ei ole täielikult märgitud (paigutamiskõht). Kui emitendil ei õnnestu soovitud emissioonimahtu koguda, saab emitent investeerida vähem. Emitendi jaoks on kapitalipuudujäägi risk. Lisaks sellele jäävad emissioonikulud, mis ei sõltu kaasatava kapitali mahust, mis suurendab kulude suhet kogutud investeerimiskapitali kogusummasse. On oht, et sellisel juhul ei saavuta emitent oma kavandatud investeerimiseesmärke ega suuda täita AWEARE Global Token'ist tulenevaid kohustusi.</p> <p><b>Juhtimine, tehnoloogia, sõltuvus kolmandatest isikutest teenusepakkujatest, konkurents ja arenguaeg.</b> Üks emitendi peamisi tugevusi on uusima radaritehnoloogia arukas kasutamine. Tehnilised eelised info- ja kommunikatsioonitehnoloogias võivad siiski olla lühiajalised. Seega sõltub emitendi edu osaliselt tema suutlikkusest hallata ja laiendada emitendi teenuseid ning kasvatada oma äritegevuse kasutajaskonda ja seega teenida tulu, reageerides muutuvatele tehnoloogiatele, kasutajate ja kolmandate osapoolte teenusepakkujate nõudmistele ning konkurentsiturule. Selle ebaõnnestumine või hilinemine võib avaldada negatiivset mõju emitendi edule.</p> <p><b>Inimlik viga arukate lepingutega</b> Emitent ei võta endale mingit vastutust ega anna mingeid kinnitusi ega garantiisid Emitendi projekti või mis tahes arukate lepingute funktsionaalsuse kohta, mida võidakse programmeerida või kasutada pakkumise arveldamiseks vastavalt käesolevale prospektile laias laastus. Investorid võivad selle tagajärjel kannatada kahju või üldjuhul sattuda täielikku kahjumisse. Selliste stsenaariumide puhul võivad siiski kehtida õiguslikud mehhanismid, mis kaitsevad investorit kahju eest.</p>
<b>3. JAGU - PÕHITEAVE VÄÄRTPABERITE KOHTA</b>	
3.1	<b>Millised on väärtpaperite peamised omadused?</b>
3.1.1	<b>Teave väärtpaperite kohta</b>
a)	<p><b>Väärtpaperite liigi ja klassi kirjeldus</b></p> <p>Emitendi poolt avalikult pakutavad <b>1 400 000</b> uut osalussertifikaati on hääleõiguseta osalussertifikaadid, millest igaühe nimiväärtus on <b>0,01 USA dollarit</b> osaluskapitalist ("<b>AWEARE Global Tokens</b>")., mis pärinevad 18/07/2024. aasta erakorralise üldkoosoleku otsusega korraldatud uuest osaluskapitali emissioonist. AWEARE Global Token'ide omanikke nimetatakse "<b>Osalejateks</b>" või "<b>Tokenholderiteks</b>".</p>
b)	<p><b>Väärtpaperiemissiooni vääring</b></p> <p>Ameerika Ühendriikide dollar ("<b>USD</b>" või "<b>\$</b>"). AWEARE Global Tokeni kehtivusaeg on piiramatu.</p>
c)	<p><b>Väärtpaperitega seotud õiguste kirjeldus</b></p> <p><b>Õigus hääletada</b> AWEARE Global Tokenid on hääleõiguseta osalustunnistused ja ei anna osalejale õigust hääletada, kutsuda kokku ja osaleda emitendi üldkoosolekul. Lisaks ei anna AWEARE Global Tokenid õigust saada teavet, õigust tutvuda ja esitada avaldusi. Üldkoosolekule võib siiski esitada kirjaliku teabe- või inspekteerimistaotluse või ametliku auditi algatamise taotluse.</p> <p><b>Üldkoosoleku kokkukutsumisest ja otsustest teatamine</b> Osalejatele tuleb teatada üldkoosoleku kokkukutsumisest koos päevakorrapunktide ja ettepanekutega. Iga üldkoosoleku otsus tuleb osavõtjatele viivitamata kättesaadavaks teha, et nad saaksid sellega tutvuda emitendi registrijärgses asukohas. Osalejaid teavitatakse sellest teates.</p> <p><b>Dividendõigus ja osa likvideerimisest saadavast tulust</b> AWEARE Global Token'idega kaasnevad täielikud dividendõigused alates kehtiva omandamise kuupäevast ja annavad nende omanikele õiguse saada osa likvideerimisest saadavast tulust proportsionaalselt nende osalusega osaluskapitalis. Emitent ei kavatse praegu lähitulevikus dividende välja maksta. Kuigi põhikirja kohaselt on õigus dividendidele, ei tehta prognoose tulevaste dividendide väljamaksmise kohta. Emitent kavatseb kasumi reinvesteerida ettevõtte edasisse kasvu ja arengusse.</p> <p><b>Vorm ja väärtpaperistamine</b> AWEARE Global Tokenid antakse välja žetoonidena. Tokenid on väärtusõigused, mis väljastatakse desentraliseeritud andmebaasis (Blockchain) ja kantakse sinna üle. Selleks kasutatav Blockchain on Ethereum Blockchain.</p>



		<p><b>Märkimisõiguse ja osalemisõiguse välistamine</b> Kuni 50 000 USA dollari suuruse sihtosaluskapitali saavutamiseni on välistatud PCLi artiklite 304d, 304f ja 304g kohased eelisõigused, eelkõige märkimisõigused ja osaliste osalusõigused.</p> <p><b>Väärtpaberite ülekantavus</b> AWEARE Global Tokenite võõrandamine (näiteks võõrandamine kitsamas tähenduses, pantimine, pärimine) nõuab Emitendi juhatuse heakskiitu. Seetõttu on ülekantavus teatud määral piiratud. Igal juhul ei ole AWEARE Global Tokenite ülekandmine lubatud, kui need oleksid seejärel isiku valduses riigis, kus AWEARE Global Tokenite pakkumine ei ole lubatud. Ülekandmine eelnimetatud tähenduses loetakse toimunuks ka siis, kui Tokeni valdaja kolib oma elukoha sellisesse riiki, kus AWEARE Global Token'eid ei tohi pakkuda.</p>
d)	<b>Väärtpaberite suhteline eelisjärjekord emitendi kapitalistruktuuris maksejõuetuse korral</b>	Emitendi maksejõuetuse korral vastutavad osalejad oma investeeritud kapitaliga. Investeeritud kapitali käsitletakse omakapitalina ja see on seetõttu kvalifitseeritud allutatud.
e)	<b>Dividendipoliitika kirjeldus</b>	Seni ei ole dividende makstud. Emitent ei tee kasumiprognose ega -hinnanguid ning seetõttu ei ole dividendipoliitikat kirjeldatud. Dividendid, kui neid makstakse, makstakse USA dollarites. Emitent jätab endale õiguse maksta dividende ka muus valuutas või krüptovaluutas. Mis tahes otsus dividendide maksmise kohta tehakse kooskõlas kohaldatava õigusega ning sõltub muu hulgas Emitendi majandustulemustest, finantsseisundist, lepingulistest piirangutest ja kapitalinõuetest. Igal juhul suunatakse 5% puhaskasumist seadusjärgsesse reservi, kuni see jõuab 10% ulatuses sissemakstud aktsiakapitalist.
<b>3.2</b>	<b>Kus väärtpaberitega kaubeldakse?</b>	
<b>3.2.1</b>	AWEARE Global Tokenid ei ole lubatud reguleeritud turul kauplemisele. Emitent jätab endale õiguse taotleda reguleeritud turul kauplemisele lubamist.	
<b>3.4</b>	<b>Millised on peamised väärtpaberitega seotud riskid?</b>	
<b>3.4.1</b>	<p><b>Investorite rahakott ja privaativõtme risk</b> Investor kannab üksi riski rahakoti valiku või privaativõtme asukoha osas. Kui kasutatakse mittesobivat rahakotti või kui privatne võti läheb kaduma, on juurdepääs AWEARE Global Tokenitele tavaliselt võimatu. Tagajärjed, näiteks investeringu täielik kaotus, peab kandma ainult investor.</p> <p><b>Likviidsuse, likviidsuse ja realiseerimise riskid</b> Ei ole kindel, et AWEARE Global Tokenite jaoks areneb likviidne turg. Seetõttu ei saa AWEARE Global Token'e müüa järelturul, mis tekitab investori jaoks likviidsusrisiki.</p> <p><b>Volatiilsuse risk</b> Aktisia hinna volatiilsusega on seotud riskid. Kui AWEARE Globali tokenid tuleks müüa ja need satuksid järsku hinnakõikumise alla, võib tokeniomanik müügist saada kahjumit, mis võib olla osaliselt märkimisväärne.</p> <p><b>Märgiste kaotamine</b> Tokenid võivad kaduda või muutuda kättesaamatuks, eelkõige juhul, kui Tokenite omanik kaotab oma AWEARE Global Tokenite käsutamiseks vajaliku isikliku võtme või kui e-rahakott, milles AWEARE Global Tokenid on salvestatud, ei toimi korralikult. See võib kaasa tuua müntide kaotuse. Tokenite omanikud vastutavad ise selle eest, et nad hoiaksid ja kaitseksid turvaliselt privaativõtit, mis võimaldab juurdepääsu e-rahakotile. Tokenid võivad muutuda kättesaamatuks ka Tokenholderi surma korral, kui ta ei ole sellisteks juhtudeks ette näinud. Ei emitent ega ükski muu asutus ega institutsioon ei ole võimeline taastama Tokenholderi järeltulijate juurdepääsu Tokenholderi rahakotile. Lisaks sellele võib isiklike võtmete kadumine vähendada STO ja AWEARE Global Tokenite erinevate funktsioonide kättesaadavust. Eelkõige võib osutuda võimatuks AWEARE Global Tokenite väljastamine tellijatele või nende ülekantavaks muutmine, mille puhul need jääksid määramata ajaks peatuma. Lisaks võib olla võimatu teha dividendimakseid. Lõpuks on oht, et ründaja võib vermida AWEARE Global Tokens'e mitteosutatavate aadresside jaoks, muuta kinnituse staatust, anda STOsse kontrollimatuid summasid või võimaldada ründajal nõuda välja saamata jäänud dividendimakseid.</p> <p><b>Tokenomanike piiratud õigused</b> AWEARE Global Tokenid on hääleõiguseta osalustunnistused ja ei anna tokenomanikele õigust hääletada emitendi üldkoosolekul, seda kokku kutsuda ega selles osaleda. Lisaks ei anna AWEARE Global Tokenid õigust saada teavet, õigust tutvuda ja esitada taotlusi. Emitendi üldkoosolek võib seega vastu võtta otsuseid, mis võivad mõjutada negatiivselt tokeniomanike õigusi. Tokenomanikel ei ole võimalust kontrollida AWEARE Global Tokenite emiteerimisest saadava tulu kasutamist. AWEARE Global Tokenite võõrandamine (näiteks võõrandamine kitsamas tähenduses, pantimine, pärimine) nõuab emitendi juhatuse heakskiitu. Igal juhul ei ole AWEARE Global Tokenite ülekandmine lubatud, kui need oleksid seejärel isiku valduses riigis, kus AWEARE Global Tokenite pakkumine ei ole lubatud. Ülekandmine eelnimetatud tähenduses loetakse toimunuks ka siis, kui tokeniomanik kolib oma elukoha</p>	

	<p>sellisesse riiki, kus AWEARE Global Token'eid ei tohi pakkuda. Väärtpaberiomanike seadusjärgne märkimisõigus käesoleva pakkumise kohase kapitali suurendamise korral on välistatud.</p> <p><b>Väärtpaberiomanike nõuded on allutatud</b> Väärtpaberiomanike õigus nõuda ja saada dividendimakseid emitendilt on allutatud kõigi emitendi allutamata kohustuste omanike nõuetele. Emitendi likvideerimise korral makstakse tokenholderitele raha ainult siis, kui ja pärast seda, kui kõik emitendi eesõiguslikud kohustused on täidetud.</p>
<b>4. JAGU - PÕHITEAVE VÄÄRTPABERITE ÜLDSUSELE PAKKUMISE KOHTA</b>	
<b>4.1</b>	<b>Millistel tingimustel ja millise ajakava alusel saan ma sellesse väärtpaberisse investeerida?</b>
<p><b>Riigid, kus väärtpabereid pakutakse</b> Pakkumine hõlmab avalikke pakkumisi Austrias, Belgias, Bulgaarias, Horvaatias, Küprosel, Tšehhi Vabariigis, Taanis, Eestis, Soomes, Prantsusmaal, Saksamaal, Kreekas, Ungaris, Islandil, Iirimaa, Itaalias, Lätis, Liechtensteinis, Leedus, Luksemburgis, Maltal, Madalmaades, Norras, Poolas, Portugalis, Rumeenias, Slovakkias, Sloveenias, Hispaanias, Rootsis, Šveitsis ja Tšehhi Vabariigis ning erapakkumisi teatud jurisdiktsioonides väljaspool neid riike.</p> <p><b>Riigid, kus väärtpabereid ei pakuta</b> Emitendi AWEARE Global Tokenid ei ole registreeritud ega registreerita Ameerika Ühendriikide 1933. aasta väärtpaberite seaduse (muudetud kujul) sätete kohaselt ega Ameerika Ühendriikide ühegi osariigi, Austraalia, Jaapani või Kanada väärtpaberiturujärelevalveasutustes. Sellest tulenevalt ei pakuta, müüda ega tarnita neid otse või kaudselt üldsusele, välja arvatud juhul, kui need on vabastatud registreerimisnõuetest. Eelkõige ei kujuta ega kujuta käesolev prospekt endast müügipakkumist ega pakkumist AWEARE Global Tokenite ostmiseks Ameerika Ühendriikides, Austraalias, Jaapanis ja Kanadas ning seda ei tohi seal levitada. Lisaks ei ole käesolev prospekt müügipakkumine ega pakkumine AWEARE Global Tokenite ostmiseks Venemaal, Iraanis, Põhja-Koreas, Valgevenes, Süürias või nende territooriumidel. Ja seda ei tohi seal levitada.</p> <p><b>Pakkumine</b> AWEARE Global Tokeni tellimine toimub veebis aadressil <a href="https://kyc.awearetech.li/">https://kyc.awearetech.li/</a> ("Dashboard").</p> <p><b>Pakkumise periood</b> Ajavahemik, mille jooksul investorid võivad esitada oma ostupakkumisi AWEARE Global Tokenite ostmiseks, algab prospekti kinnitamise kuupäeval ja lõpeb aasta hiljem ("<b>pakkumisperiood</b>"). Pakkumisperioodi viimasel päeval võib pakkumisi teha kuni kella 12:00ni Liechtensteini aja järgi.</p> <p><b>Pakkumise hind</b> Ühe AWEARE tokeni pakkumishind on <b>12,00 USD</b> ("<b>pakkumishind</b>").</p> <p>Varajase investeerimise soodustamiseks on saadaval järgmised soodustused:</p> <p>Investeeringute puhul vahemikus 10 000 USDC kuni 49 999,99 USDC saavad investorid 10% allahindlust, mis teeb ühe AWEARE tokeni hinnaks 10,80 USD.</p> <p>50 000 USDC või suurema investeeringu korral saavad investorid 15% allahindlust, mis teeb ühe AWEARE tokeni hinnaks 10,20 USD.</p> <p><b>Allahindluste kättesaadavus</b> Eespool nimetatud allahindlused on saadaval <b>kuni üks järgmistest sündmustest saabub, olenevalt sellest, kumb saabub esimesena:</b></p> <ul style="list-style-type: none"> <li>• <b>saavutada investeeringute kogumaht 5 000 000 USDC</b> või</li> <li>• <b>kolme kuu jooksul alates pakkumise algusest.</b></li> </ul> <p><b>Kohaletoiemamine ja arveldamine</b> Iga investor peab täitma veebipõhise märkimisprotsessi armatuurlaual. AWEARE Global Tokenid eraldatakse väljaspool ahelat kui kirje emitendi andmebaasis, mis on nähtav Dashboardi kaudu, vastu pakkumishinna tasumist. AWEARE Global Tokenid jaotatakse arukate lepingute ahelas hiljemalt kahe kuu jooksul pärast pakkumisperioodi lõppu. Kui AWEARE Global Tokenite kogu pakkumine (pärast osalemise sihtkapitali saavutamist) on lõppenud ja emitent on otsustanud Smart Contracti lõpule viia, toimetatakse AWEARE Global Tokenid investorite krüpto rahakotti.</p> <p><b>Lahjendus</b> Kuna käesoleva pakkumise raames toimuva kapitali suurendamise korral on kõigi osalejate seadusjärgne märkimisõigus välistatud, ei lahjendata käesoleva pakkumise osalejaid.</p> <p><b>Netotulu ja hinnangulised emissioonikulud kokku</b> Pakkumise netotulu üle 1 400 000 AWEARE Global Tokenit võib kokku ulatuda ligikaudu <b>15 000 000 USA dollarini</b>, mis vastab fondi suurendamise rakendamisele. Pakkumise eeldatavad kogukulud on ligikaudu <b>1 500 000 USA dollarit</b> ja need kaetakse tuludest.</p>	

<b>4.2</b>	<b>Miks see prospekt koostatakse?</b>
<b>4.2.1</b>	<p>a) Väärtpaberite emiteerimisest saadav hinnanguline puhastulu kasutatakse peamiselt teadus- ja arendustegevuseks ning intellektuaalomandi õiguste kaitseks. Vajaduse korral võib olla vaja kuni 50% eraldatud eelarvest ümber paigutada mõnele teisele ametikohale.</p> <p>i) 10% töstmise kulud  ii) 11% Üld- ja halduskulud  iii) 41% Teadus- ja arendustegevus  iv) 17% juriidiline (ülemaailmne intellektuaalomandi kaitse)  v) 21% Bussiarendus, müük ja turundus</p> <p>b) AWEARE Technologies Inc. ja Global Innovation Partners Limited praeguste aktsionäride hulka kuuluvad Mahesh Reddy ja Dr. Daniel Hyman. Mahesh Reddy ja Dr. Daniel Hyman on ka emitendi direktorid ja vähemusaktsionärid.</p> <p>c) Equanimity AG saab tehingutasu 3% kogunenud krüptovaluutade ja fiat-maksete kogusummast. Marcel Füssinger, kes on üks emitendi direktoritest, on ka Equanimity AG direktor ja omanik.</p> <p>d) <b>Netotulu ja hinnangulised emissioonikulud kokku</b>  Pakkumisest saadav netotulu üle 1 400 000 AWEARE Global Tokeni võib kokku ulatuda ligikaudu <b>15 000 000 USA dollarini</b>, mis vastab fondi suurendamise rakendamisele. Pakkumise eeldatavad kogukulud on ligikaudu <b>1 500 000 USA dollarit</b> ja need kaetakse tuludest.</p> <p>e) <b>Tagatiskokkulepped</b>  Pakkumine ei ole seotud kindla emissioonilepinguga. Puudub leping, mille kohaselt oleks investor kohustatud märkide müümata jätmise üle võtma. Seetõttu ei ole mingit garantiid, et kogu pakkumine paigutatakse.</p>

## XI. ESITTEEN TIIVISTELMÄ

Tämä tiivistelmä sisältää kaikki tiedot, jotka on sisällytettävä tiivistelmään tämän tyyppisten arvopapereiden ja liikkeeseenlaskijoiden osalta.

1 JAKSO - JOHDANTO		
<b>1.1</b>	<b>Arvopapereiden nimi ja ISIN-tunnus</b>	Julkisesti julkistettavat <b>1 400 000</b> uutta osuustodistusta ovat AWEARE Global AG:n äänioikeudettomia haltijaosuustodistuksia. Näiden osallistumistodistusten nimi on " <b>AWEARE Global Tokens</b> ". ISIN-tunnus on LI1363014385.
<b>1.2</b>	<b>Liikkeeseenlaskijan henkilöllisyys ja yhteystiedot, mukaan lukien sen oikeushenkilötunnus (LEI).</b>	<b>AWEARE Global AG ("liikkeeseenlaskija")</b> c/o Revalier Aktiengesellschaft Pradafant 11, 9490 Vaduz, Vaduzin ruhtinaskunta, Pradafant 11, 9490 Vaduz, Vaduzin ruhtinaskunta. Puh: +423 237 63 47 Sähköposti: info@awearetech.li LEI on: 391200PTNEZNXGJW1C39
<b>1.3</b>	<b>Toimivaltainen viranomainen</b>	<b>Rahoitusmarkkinaviranomainen ("FMA")</b> Landstrasse 109, 9490 Vaduz, Liechtensteinin ruhtinaskunta Puh: +423 236 73 73 Faksi: +423 236 73 74 Sähköposti: <a href="mailto:info@fma-li.li">info@fma-li.li</a>
<b>1.4</b>	<b>Esitteen hyväksymispäivä</b>	05/12/2024
<b>1.5</b>	<b>Varoitukset</b>	
<b>1.5.1</b>		<p>a) Tiivistelmää tulisi lukea esitteen johdantona. Sijoittajan tulisi tehdä päätös arvopapereihin sijoittamisesta tutustumalla esitteeseen kokonaisuudessaan.</p> <p>b) Sijoittaja voi menettää sijoitetun pääoman kokonaan tai osittain.</p> <p>c) Jos esitteen sisältämiä tietoja koskeva kanne viedään tuomioistuimeen, kantajana olevan sijoittajan on kansallisen lainsäädännön mukaan mahdollisesti vastattava esitteen kääntämisestä aiheutuvista kustannuksista ennen oikeudenkäynnin aloittamista.</p> <p>d) Siviilioikeudellinen vastuu koskee ainoastaan niitä henkilöitä, jotka ovat esittäneet tiivistelmän ja sen käännöksen, mutta vain jos tiivistelmä on harhaanjohtava, epätarkka tai epä johdonmukainen, kun sitä luetaan</p>

yhdessä esitteen muiden osien kanssa, tai jos siinä ei anneta esitteen muiden osien kanssa luettuna keskeisiä tietoja, jotka auttavat sijoittajia harkitsemaan arvopapereihin sijoittamista.

## 2 JAKSO - LIIKKEESEENLASKIJAA KOSKEVAT KESKEISET TIEDOT

### 2.1 Kuka on arvopaperien liikkeeseenlaskija?

#### 2.1.1 Liikkeeseenlaskijaa koskevat tiedot

- a) Liikkeeseenlaskijan virallinen ja kaupallinen nimi on "AWEARE Global AG". Liikkeeseenlaskija on Liechtensteinin ruhtinaskunnassa perustettu julkinen osakeyhtiö, johon sovelletaan Liechtensteinin ruhtinaskunnan lakeja. Liikkeeseenlaskijan sääntömääräinen kotipaikka on Vaduzissa, Liechtensteinin ruhtinaskunnassa, ja se on rekisteröity Liechtensteinin ruhtinaskunnan oikeusvirastoon / kaupparekisteriin rekisterinumeroilla FL-0002.714.015-4.
- b) Liikkeeseenlaskijan tarkoituksena on kehittää ja hyödyntää anturitekniologiaa ja tekoälyä itsenäisiä ajoneuvoja ja muita sovelluksia varten.
- c) Liikkeeseenlaskijan tärkeimmät osakkeenomistajat ovat:
- Global Innovation Partners Limited, Brittiläiset Neitsytsaaret, enemmistöosakkaat Dr. Daniel Hyman, Mahesh Reddy, Dr. Reginald Tang ja Mark Hyman.
- d) Liikkeeseenlaskijan hallitukseen kuuluvat:
- Tohtori Daniel Hyman, Kansalaisuus: Hyman, Kansalaisuus: Yhdysvallat, Postiosoite: Hyman Hyman: Long Beach, Kalifornia, Yhdysvallat
  - Mahesh Reddy, Kansalaisuus: United States, Mailing Address: Irvine, California, USA
  - Marcel Füssinger, Kansalaisuus: Füssinger: Kansalaisuus: Itävalta, Postiosoite: Itävalta, Postiosoite: 160009, Singapore
  - Revalier AG, edustaja: Reinhold Wohlwend, Kansalaisuus: Liechtenstein, postiosoite: Liechtenstein: 9490, Vaduz, Liechtenstein
- e) Tilintarkastaja on: Lucas Tihanyi, Liechtensteinin tilintarkastusyhdistyksen jäsen ja EXPERTsuisse, Industriering 14, 9491 Ruggell, Liechtenstein.

### 2.2 Mitkä ovat liikkeeseenlaskijan tärkeimmät taloudelliset tiedot?

Liikkeeseenlaskija perustettiin 30.11.2023 merkityksellä se Liechtensteinin ruhtinaskunnan kaupparekisteriin. Hallituksen 25.10.2023 päivätyn ilmoituksen mukaan liikkeeseenlaskijaan ei sovelleta tavanomaista tilintarkastusta eikä tilintarkastusta. Tilintarkastaja on kuitenkin tarkastanut 31.12.2023 päivätyn vuositilinpäätöksen ja 15.7.2023 päivätyn osavuositarkastuksen.

Seuraavat keskeiset taloudelliset tiedot on laadittu Liechtensteinin henkilö- ja osakeyhtiölain (PCL) säännösten ja erityisesti Liechtensteinin osakeyhtiölain (PCL) 1 §:n mukaisesti. 1024 ja sitä seuraavat artiklat.

#### Tuloslaskelma

	31/12/2023	15/07/2024
<b>Tulot yhteensä</b>	USD 0	USD 0
<b>Liikevoitto/tappio</b>	USD -2'473.03	USD -30'150.54
<b>Nettovoitto/tappio</b>	USD -2'473.03	USD -30'150.54

2.2.1

#### Tase

	31/12/2023	15/07/2024
<b>Varat yhteensä</b>	USD 50'184.35	USD 75'244.30
<b>Oma pääoma yhteensä</b>	USD 47,526.97	USD 19'849.46
<b>Nettorahoitusvelka (pitkäaikainen velka plus lyhytaikainen velka miinus käteisvarat)</b>	USD 0	USD 0

#### Rahavirtalaskelma

		31/12/2023	15/07/2024
	<b>Asianomainen netto Liiketoiminnan rahavirta</b>	USD 0	USD 0
	<b>Merkityksellinen netto Investointien rahavirta</b>	USD 0	USD 0
	<b>Asiaankuuluva netto Rahoitustoiminnan rahavirrat</b>	USD 0	USD 0
<p>Liikkeeseenlaskijan näkymät eivät ole merkittävästi heikentyneet 15.7.2024 päivätyn välitilinpäätöspäivän jälkeen. Liikkeeseenlaskijan taloudellisessa asemassa tai kaupankäyntiasemassa ei ole tapahtunut merkittäviä muutoksia 15/07/2024 päivätyn välitaseen raportointipäivän jälkeen.</p>			
<b>2.3</b>	<b>Mitkä ovat liikkeeseenlaskijalle ominaiset keskeiset riskit?</b>		
	<p><b>Vähäinen pääoma</b> Liikkeeseenlaskijan tarkoituksena on AWEAREN teknologian kaupallistaminen. Liikkeeseenlaskijan oma pääoma on rajoitettu 50 000,00 Yhdysvaltain dollariin, kun Liechtensteinin lainsäädännön edellyttämä vähimmäispääoma on 50 000,00 Yhdysvaltain dollaria. Koska liikkeeseenlaskija on perustettu 30.11.2023, tämän tiivistelmän kohdassa 2.2.1 tarkoitettuja historiallisia taloudellisia tietoja lukuun ottamatta ei ole saatavilla muita merkittäviä taloudellisia tietoja tai tunnuslukuja, joiden perusteella voitaisiin arvioida liikkeeseenlaskijan taloudellista tilannetta viime vuosien osalta. Liikkeeseenlaskijaan ei sovelleta tavanomaista tilintarkastusta eikä sillä ole tilintarkastuskatsausta. Luottoluokituslaitos ei ole arvioinut liikkeeseenlaskijaa. Alhainen oma pääoma merkitsee sijoittajalle lisääntynyttä riskiä, koska sen tehtävä vastuullisena pääomana on vastaavasti vähentynyt.</p> <p><b>Maksukyvyttömyysriski</b> Jos liikkeeseenlaskijan omaisuutta koskeva maksukyvyttömyysmenettely aloitetaan, liikkeeseenlaskija saa väliaikaisesti tai pysyvästi rajoittaa omaisuutensa luovuttamista, tai tuomioistuimen määräämä maksukyvyttömyyspesänhoitaja ottaa vastuulleen liikkeeseenlaskijan omaisuuden luovuttamisen. Tällä voi olla kielteinen vaikutus liikkeeseenlaskijan taloudelliseen asemaan ja liiketoimintaan. Tämä tapaus voi toteutua, vaikka maksukyvyttömyyshakemus olisi jätetty virheellisesti. Liikkeeseenlaskijan maksukyvyttömyystilanteessa osallistujat ovat vastuussa sijoittamallaan pääomalla. Sijoitettu pääoma on rinnastettava omaan pääomaan, ja se on siten etuoikeudeltaan huonommassa asemassa.</p> <p><b>Yritysten rahoitus</b> Kerättävää vähimmäispääomaa ei ole. Sijoitustakuuta ei ole olemassa, vaan pikemminkin riski siitä, että AWEARE Global Tokens -markkinoita ei merkitä kokonaan (sijoitusriski). Jos liikkeeseenlaskija ei onnistu hankkimaan toivottua liikkeeseenlaskuvolyymia, liikkeeseenlaskija voi sijoittaa vähemmän. Liikkeeseenlaskijalle aiheutuu riski pääomavajeesta. Lisäksi kerätyn pääoman määrästä riippumattomat päästökustannukset jäävät jäljelle, mikä nostaa kulusuhdetta suhteessa kerättyyn kokonaissijoituspääomaan. On olemassa riski, että tässä tapauksessa liikkeeseenlaskija ei saavuta aiottuja sijoitustavoitteitaan eikä pysty täyttämään AWEARE Global Token -ohjelman mukaisia velvoitteitaan.</p> <p><b>Johtaminen, teknologia, riippuvuus kolmansista osapuolista, kilpailu ja kehitysaikataulut.</b> Yksi liikkeeseenlaskijan keskeisistä vahvuuksista on uusimman tutkateknologian älykäs käyttö. Tieto- ja viestintätekniikan alalla tekniset edut voivat kuitenkin olla lyhytaikaisia. Näin ollen liikkeeseenlaskijan menestys riippuu osittain sen kyvystä hallinnoida ja laajentaa liikkeeseenlaskijan palveluja ja kasvattaa liiketoimintansa käyttäjäkuntaa ja siten tuottaa tuloja vastauksena muuttuviin teknologioihin, käyttäjien ja kolmansien osapuolten palveluntarjoajien vaatimuksiin ja kilpailupaineisiin. Epäonnistuminen tai viivästyminen tässä saattaa vaikuttaa kielteisesti Liikkeeseenlaskijan menestykseen.</p> <p><b>Inhimilliset virheet älykkäiden sopimusten kanssa</b> Liikkeeseenlaskija ei ota vastuuta eikä anna mitään vakuutuksia tai takuita liikkeeseenlaskijoiden hankkeen tai älysopimusten toimivuudesta, jotka voidaan ohjelmoida tai joita voidaan käyttää tarjouksen selvittämiseen tämän esitteen mukaisesti laajimmassa merkityksessä. Sijoittajat voivat kärsiä sen seurauksena arvonalennuksia tai yleisesti ottaen joutua kärsimään täydellisen tappion. Tällaisissa tilanteissa voidaan kuitenkin soveltaa oikeudellisia mekanismeja, jotka suojaavat sijoittajaa tappioilta.</p>		
<b>2.3.1</b>	<p>Kerättävää vähimmäispääomaa ei ole. Sijoitustakuuta ei ole olemassa, vaan pikemminkin riski siitä, että AWEARE Global Tokens -markkinoita ei merkitä kokonaan (sijoitusriski). Jos liikkeeseenlaskija ei onnistu hankkimaan toivottua liikkeeseenlaskuvolyymia, liikkeeseenlaskija voi sijoittaa vähemmän. Liikkeeseenlaskijalle aiheutuu riski pääomavajeesta. Lisäksi kerätyn pääoman määrästä riippumattomat päästökustannukset jäävät jäljelle, mikä nostaa kulusuhdetta suhteessa kerättyyn kokonaissijoituspääomaan. On olemassa riski, että tässä tapauksessa liikkeeseenlaskija ei saavuta aiottuja sijoitustavoitteitaan eikä pysty täyttämään AWEARE Global Token -ohjelman mukaisia velvoitteitaan.</p>		
<b>3 JAKSO - ARVOPAPEREITA KOSKEVAT KESKEISET TIEDOT</b>			
<b>3.1</b>	<b>Mitkä ovat arvopapereiden pääpiirteet?</b>		
<b>3.1.1</b>	<b>Arvopapereita koskevat tiedot</b>		
<b>a)</b>	<b>Kuvaus arvopapereiden tyypistä ja luokasta</b>	Liikkeeseenlaskijan julkisesti tarjoamat <b>1 400 000</b> uutta osuustodistusta ovat äänioikeudettomia haltijaosuustodistuksia, joiden kunkin nimellisarvo on <b>0,01 Yhdysvaltain dollaria</b> osuustoimintapääomasta (jäljempänä 'AWEARE Global Tokens') ja jotka ovat peräisin ylimääräisessä yhtiökokouksessa 18.7.2024	

		hyväksytystä osuustoimintapäätöksen uusmerkinnästä. AWEARE Global Tokensin haltijoita kutsutaan " <b>osallistujiksi</b> " tai " <b>Tokenholdereiksi</b> ".
b)	<b>Arvopapereiden liikkeeseenlaskun valuutta</b>	Yhdysvaltain dollari ("USD" tai "\$"). AWEARE Global Tokenin voimassaoloaika on rajoittamaton.
c)	<b>Kuvaus arvopapereihin liittyvistä oikeuksista</b>	<p><b>Äänioikeus</b> AWEARE Global Tokens -osuustodistukset ovat äänioikeudettomia osallistumistodistuksia, eivätkä ne oikeuta osallistujaa äänestämään liikkeeseenlaskijan yhtiökokouksessa, kutsumaan sitä koolle tai osallistumaan siihen. AWEARE Global Tokens ei myöskään oikeuta tiedonsaantioikeuteen, tarkastusoikeuteen eikä hakemuksen tekemiseen. Yhtiökokoukselle voi kuitenkin esittää kirjallisen tieto- tai tarkastuspyynnön tai virallisen tarkastuksen aloittamista koskevan pyynnön.</p> <p><b>Ilmoitus yhtiökokouksen koollekutsumisesta ja päätöksistä</b> Osallistujille on ilmoitettava yhtiökokouksen koollekutsumisesta sekä esityslistan kohdat ja esitykset. Jokainen yhtiökokouksen päätös on asetettava viipymättä osallistujien nähtäväksi liikkeeseenlaskijan kotipaikassa. Osallistujille on ilmoitettava tästä kokouskutsussa.</p> <p><b>Osinko-oikeus ja osuus selvitystulosta</b> AWEARE Global Tokens -osuustodistuksilla on täydet osinko-oikeudet voimassa olevasta hankintapäivästä alkaen, ja ne oikeuttavat haltijansa osuuteen selvitystulosta suhteessa heidän osuuteensa osallistumispääomasta. Liikkeeseenlaskija ei tällä hetkellä suunnittele osingonjakoa lähitulevaisuudessa. Vaikka yhtiöjärjestyksen mukaan oikeus osinkoihin on olemassa, tulevasta osingonjaosta ei tehdä ennusteita. Liikkeeseenlaskija aikoo sijoittaa voitot uudelleen yhtiön kasvuun ja kehittämiseen.</p> <p><b>Muoto ja arvopaperistaminen</b> AWEARE Global Tokenit lasketaan liikkeeseen rahakkeina. Tokenit ovat arvo-oikeuksia, jotka lasketaan liikkeeseen hajautetussa tietokannassa (Blockchain) ja siirretään sinne. Tähän tarkoitukseen käytetty lohkoketju on Ethereum-lohkoketju.</p> <p><b>Merkintä- ja osallistumisoikeuksien poissulkeminen</b> Ennen kuin 50 000 Yhdysvaltain dollarin tavoitepääoma on saavutettu, PCL:n 304 d, 304 f ja 304 g §:n mukaiset etuoikeudet, erityisesti osallistujien merkintäoikeudet ja osallistumisoikeudet, suljetaan pois.</p> <p><b>Arvopapereiden siirrettävyys</b> AWEARE Global Tokenien siirto (kuten siirto suppeassa merkityksessä, panttaaminen, periminen) edellyttää liikkeeseenlaskijan hallituksen hyväksyntää. Luovutettavuus on siten rajoitettu tiettyssä määrin. AWEARE Global Tokenien siirto ei missään tapauksessa ole sallittua, jos ne olisivat tällöin sellaisen henkilön hallussa, joka asuu maassa, jossa AWEARE Global Tokeneita ei saa tarjota. Edellä mainitussa merkityksessä tapahtuvaksi siirroksi katsotaan myös se, että tokeninhaltija siirtää asuinpaikkansa maahan, jossa AWEARE Global Tokens -arvopapereita ei saa tarjota.</p>
d)	<b>Arvopapereiden suhteellinen etuoikeusjärjestys liikkeeseenlaskijan pääomarakenteessa maksukyvyttömyystilanteessa.</b>	Liikkeeseenlaskijan maksukyvyttömyystilanteessa osallistajat ovat vastuussa sijoittamastaan pääomasta. Sijoitettu pääoma rinnastetaan omaan pääomaan, ja se on siten etuoikeudeltaan huonommassa asemassa.
e)	<b>Osinkopolitiikan kuvaus</b>	Osinkoja ei ole tähän mennessä maksettu. Liikkeeseenlaskija ei tee tulosennusteita tai -arvioita, joten osinkopolitiikkaa ei kuvata. Mahdolliset osingot maksetaan Yhdysvaltain dollareina. Liikkeeseenlaskija pidättää oikeuden maksaa osinkoja myös muussa valuutassa tai kryptovaluutassa. Osingonmaksupäätös tehdään sovellettavan lainsäädännön mukaisesti, ja se riippuu muun muassa liikkeeseenlaskijan liiketoiminnan tuloksesta, taloudellisesta asemasta, sopimusrajoituksista ja pääomavaatimuksista. Joka tapauksessa 5 % nettovoitosta ohjataan lakisääteisiin rahastoihin, kunnes se on saavuttanut 10 % maksetusta osakepääomasta.
3.2	<b>Missä arvopapereilla käydään kauppaa?</b>	
3.2.1		AWEARE Global Tokens -markkinoita ei ole hyväksytty kaupankäynnin kohteeksi säännellyillä markkinoilla. Liikkeeseenlaskija pidättää oikeuden hakea kaupankäynnin aloittamista säännellyillä markkinoilla.

3.4	<b>Mitkä ovat arvopapereihin liittyvät keskeiset riskit?</b>
3.4.1	<p><b>Sijoittajien lompakko ja yksityisen avaimen riski</b> Sijoittaja kantaa yksin riskin lompakon valinnasta tai yksityisen avaimen sijainnista. Jos käytetään yhteensopimatonta lompakkoa tai jos yksityinen avain katoaa, AWEARE Global Tokenien käyttö on yleensä mahdotonta. Seuraukset, kuten sijoituksen täydellinen menettäminen, jäävät yksin sijoittajan vastuulle.</p> <p><b>Myytävyys-, likviditeetti- ja realisointiriski</b> Ei ole varmuutta siitä, että AWEARE Global Tokensille kehittyvät markkinat. Tämän seurauksena AWEARE Global Tokens -markkinoita ei voida myydä jälkimarkkinoilla, mikä aiheuttaa sijoittajalle likviditeettiriskin.</p> <p><b>Volatiliteettiriski</b> Osakekurssin volatiliiteettiin liittyy riskejä. Jos AWEARE Global Tokenit myytäisiin ja ne joutuisivat jyrkkään alaspäin suuntautuvaan kurssivaihteluun, Tokenin haltija voisi kärsiä myynnin seurauksena tappioita, joista osa voisi olla huomattavia.</p> <p><b>Merkkien menettäminen</b> Tokenit voivat kadota tai niiden käyttö voi estyä, erityisesti jos Tokenin haltija menettää AWEARE Global Tokeniensä luovuttamiseen tarvittavan yksityisen avaimen tai jos AWEARE Global Tokenit sisältävässä sähköisessä lompakossa on toimintahäiriö. Tämä voi johtaa Tokenien menettämiseen. Tokeninhaltijoiden yksinomaisella vastuulla on säilyttää ja suojata turvallisesti yksityinen avain, jonka avulla pääsee käsiksi sähköiseen lompakkoon. Tokenit voivat jäädä käyttökelvottomiksi myös siinä tapauksessa, että Tokenholder kuolee, jos hän ei ole varautunut tällaisiin tapauksiin. Liikkeeseenlaskija tai mikään muu elin tai laitos ei pysty palauttamaan Tokenholderin lompakkoon pääsyä Tokenholderin seuraajille. Yksityisten avainten katoaminen voi lisäksi heikentää STO:n ja AWEARE Global Tokenin eri toimintojen saatavuutta. Erityisesti voi olla mahdotonta laskea liikkeeseen AWEARE Global Tokens -merkkejä tilaajille tai tehdä niistä siirrettäviä, jolloin ne pysyisivät tauolla loputtomiin. Lisäksi osinkojen maksaminen voi olla mahdotonta. Lopuksi on olemassa riski, että hyökkääjä voi lypsyä AWEARE Global Tokens -merkkejä osoitteisiin, jotka eivät ole osallistujia, muuttaa vahvistustilaa, maksaa valvomattomia määriä STO:lle tai antaa hyökkääjälle mahdollisuuden nostaa lunastamattomia osinkomaksuja.</p> <p><b>Osakkeenomistajan rajoitetut oikeudet</b> AWEARE Global Tokens -osuustodistukset ovat äänioikeudettomia osallistumistodistuksia, eivätkä ne oikeuta osakkeenomistajia äänestämään liikkeeseenlaskijan yhtiökokouksessa, kutsumaan sitä koolle tai osallistumaan siihen. AWEARE Global Tokens ei myöskään oikeuta tiedonsaantioikeuteen, tarkastusoikeuteen eikä hakemuksen tekemiseen. Liikkeeseenlaskijan yhtiökokous voi näin ollen tehdä päätöksiä, jotka voivat vaikuttaa kielteisesti tokeninhaltijoiden oikeuksiin. Tokenhaltijoilla ei ole mahdollisuutta valvoa AWEARE Global Tokenien liikkeeseenlaskusta saatavien tulojen käyttöä. AWEARE Global Tokenien siirto (kuten siirto suppeassa merkityksessä, panttaus, perintö) edellyttää liikkeeseenlaskijan hallituksen hyväksyntää. AWEARE Global Tokenien siirto ei missään tapauksessa ole sallittua, jos ne olisivat tällöin sellaisen henkilön hallussa, joka on maassa, jossa AWEARE Global Tokeneita ei saa tarjota. Edellä mainitussa merkityksessä tapahtuvaksi siirroksi katsotaan myös se, että tokeninhaltija siirtää asuinpaikkansa maahan, jossa AWEARE Global Tokens -arvopapereita ei saa tarjota. Tokenhaltijoiden lakisääteinen merkintäoikeus tämän tarjouksen mukaisen pääoman korotuksen yhteydessä on suljettu pois.</p> <p><b>Tokenhaltijoiden saamiset ovat etuoikeusasemaltaan huonommassa asemassa</b> Tokenhaltijoiden oikeus vaatia ja saada osinkoja Liikkeeseenlaskijalta on etuoikeusasemaltaan huonompi kuin kaikkien Liikkeeseenlaskijan etuoikeusasemaltaan huonommassa asemassa olevien velvoitteiden haltijoiden saamiset. Liikkeeseenlaskijan selvitystilassa Tokenholderin haltijoille maksetaan korvaus vain, jos ja kun kaikki Liikkeeseenlaskijan etuoikeudet velat on maksettu.</p>
<b>4 JAKSO - ARVOPAPEREIDEN TARJOAMISTA YLEISÖLLE KOSKEVAT KESKEISET TIEDOT</b>	
4.1	<b>Millä ehdoilla ja aikataululla voin sijoittaa tähän arvopaperiin?</b>
<p><b>Maat, joissa arvopapereita tarjotaan</b> Tarjous koostuu julkisista tarjouksista Itävallassa, Belgiassa, Bulgariassa, Kroatiaassa, Kyproksella, Tšekissä, Tanskassa, Virossa, Suomessa, Ranskassa, Saksassa, Kreikassa, Unkarissa, Islannissa, Irlannissa, Irlannissa, Italiassa, Latviassa, Liechtensteinissa, Liettuassa, Luxemburgissa, Maltalla, Alankomaissa, Norjassa, Puolassa, Portugalissa, Romaniassa, Slovakiassa, Sloveniassa, Espanjassa, Ruotsissa, Sveitsissä ja Tšekin tasavallassa sekä yksityisistä tarjouksista tietyillä lainkäyttöalueilla niiden ulkopuolella.</p> <p><b>Maat, joissa arvopapereita ei tarjota</b> Liikkeeseenlaskijan AWEARE Global Tokens -arvopapereita ei ole rekisteröity eikä tulla rekisteröimään Yhdysvaltain vuoden 1933 arvopaperilain (United States Securities Act of 1933, muutoksineen) säännösten mukaisesti eikä minkään Yhdysvaltain osavaltion, Australian, Japanin tai Kanadan arvopaperivalvontaviranomaisten toimesta. Näin ollen niitä ei tarjota, myydä tai toimiteta suoraan tai välillisesti yleisölle, ellei niitä ole vapautettu rekisteröintivaatimuksista. Erityisesti tämä esite ei muodosta eikä ole myyntitarjous tai tarjouspyyntö AWEARE Global Tokensin ostamiseksi Amerikan yhdysvalloissa, Australiassa, Japanissa ja Kanadassa, eikä sitä saa levittää näissä valtioissa. Tämä esite ei myöskään ole tarjous tai tarjouspyyntö AWEARE Global Tokensin ostamisesta Venäjällä, Iranissa, Pohjois-Koreassa, Valko-Venäjällä, Syyriassa tai niiden alueilla. Eikä sitä saa levittää siellä.</p>	

## Tarjouskilpailu

AWEARE Global Tokenien merkintäprosessi tapahtuu verkossa osoitteessa <https://kyc.awaretech.li/> ("Dashboard").

## Tarjousaika

Aika, jonka aikana sijoittajat voivat tehdä ostotarjouksia AWEARE Global Tokens -merkeistä, alkaa Esitteen hyväksymispäivästä ja päättyy vuoden kuluttua ("Tarjousaika"). Tarjousajan viimeisenä päivänä tarjouksia voi tehdä klo 12:00 asti Liechtensteinin aikaa.

## Tarjoushinta

Yhden AWEARE Tokenin tarjoushinta on **12,00 USD** ("Tarjoushinta").

Varhaisten investointien kannustamiseksi on saatavilla seuraavat alennukset:

Sijoittajat saavat 10 000 USDC:n ja 49 999,99 USDC:n välisistä sijoituksista 10 %:n alennuksen, jolloin yhden AWEARE-tokenin hinta on 10,80 USD.

Sijoittajat saavat vähintään 50 000 USDC:n suuruisista sijoituksista 15 prosentin alennuksen, jolloin yhden AWEARE-tokenin hinta on 10,20 USD.

## Alennusten saatavuus

Edellä mainitut alennukset ovat käytettävissä, **kunnes jokin seuraavista tapahtuu, riippuen siitä, kumpi tapahtuu ensin:**

- saavuttaa 5 000 000 USDC:n kokonaisinvestointimäärän, tai
- kolmen kuukauden kuluessa tarjouksen alkamisesta.

## Toimitus ja selvitys

Jokaisen sijoittajan on suoritettava sähköinen tilausprosessi Dashboardissa. AWEARE Global Tokenit jaetaan ketjun ulkopuolella tietueena liikkeeseenlaskijan tietokannassa, joka on nähtävissä Dashboardin kautta, tarjoushinnan maksamista vastaan. AWEARE Global Tokenit allokoidaan ketjussa älykkäässä sopimuksessa viimeistään kahden kuukauden kuluessa tarjousajan päättymisestä. Kun AWEARE Global Tokenien kokonaistarjoaminen (tavoitellun osallistumis pääoman saavuttamisen jälkeen) on päättynyt ja liikkeeseenlaskija on päättänyt viimeistellä Smart Contractin, AWEARE Global Tokenit toimitetaan sijoittajan kryptolompakkoon.

## Laimennus

Koska kaikkien osallistujien lakisääteinen merkintäoikeus on poissuljettu tämän tarjouksen yhteydessä toteutettavassa pääomankorotuksessa, tämän tarjouksen osallistujat eivät laimene.

## Nettotuotto ja arvioidut liikkeeseenlaskukustannukset yhteensä

Tarjouksen nettotuotot yli 1 400 000 AWEARE Global Tokenin osalta voivat olla yhteensä noin **15 000 000 Yhdysvaltain dollaria**, mikä vastaa varainhankinnan toteuttamista. Tarjouksen odotetut kokonaiskustannukset ovat noin **1 500 000 USD**, ja ne veloitetaan tuotoista.

<b>4.2</b>	<b>Miksi tämä esite laaditaan?</b>
<b>4.2.1</b>	<p>a) Arvopapereiden liikkeeseenlaskusta saatava arvioitu nettotuotto käytetään ensisijaisesti tutkimus- ja kehitystyöhön sekä teollis- ja tekijänoikeuksien suojaamiseen. Tarvittaessa saattaa olla tarpeen siirtää enintään 50 prosenttia myönnetystä budjetista toiseen tehtävään.</p> <ul style="list-style-type: none"><li>i) 10 % korotuksen kustannukset</li><li>ii) 11% Yleiset ja hallinnolliset menot</li><li>iii) 41% Tutkimus ja kehitys</li><li>iv) 17 % Oikeudellinen (maailmanlaajuinen teollis- ja tekijänoikeuksien suoja)</li><li>v) 21% Bus Dev, myynti ja markkinointi</li></ul> <p>b) AWEARE Technologies Inc:n ja Global Innovation Partners Limitedin nykyisiin osakkeenomistajiin kuuluvat Mahesh Reddy ja tohtori Daniel Hyman. Mahesh Reddy ja Dr. Daniel Hyman ovat myös liikkeeseenlaskijan johtajia ja vähemmistöosakkaita.</p> <p>c) Equanimity AG saa transaktiomaksun, joka on 3 % kertyneiden kryptovaluuttojen ja fiat-maksujen kokonaismäärästä. Marcel Füssinger, joka on yksi liikkeeseenlaskijan johtajista, on myös Equanimity AG:n johtaja ja omistaja.</p> <p>d) <b>Nettotuotto ja arvioidut liikkeeseenlaskukustannukset yhteensä</b> Tarjouksen nettotuotot yli 1 400 000 AWEARE Global Tokenin osalta voivat olla yhteensä noin <b>15 000 000 Yhdysvaltain dollaria</b>, mikä vastaa varainhankinnan toteuttamista. Tarjouksen odotetut kokonaiskustannukset ovat noin <b>1 500 000 USD</b>, ja ne veloitetaan tuotoista.</p> <p>e) <b>Merkintäjärjestelyt</b> Osakeantiin ei liity sitovaa merkintäsopimusta. Mikään sopimus ei velvoita merkitsijää merkittämään myymättömiä merkkejä. Näin ollen ei ole mitään takeita siitä, että koko tarjous sijoitetaan.</p>



## XII. RÉSUMÉ DU PROSPECTUS

Le présent résumé contient tous les éléments devant figurer dans un résumé pour ce type de valeurs mobilières et d'émetteur.

SECTION 1 - INTRODUCTION	
1.1	<p><b>Nom et ISIN des titres</b></p> <p>Les <b>1 400 000</b> nouveaux titres de participation sont des titres de participation au porteur sans droit de vote d'AWEARE Global AG. Le nom de ces titres de participation est "<b>AWEARE Global Tokens</b>". L'ISIN est LI1363014385.</p>
1.2	<p><b>Identité et coordonnées de l'émetteur, y compris son identifiant d'entité légale (LEI)</b></p> <p><b>AWEARE Global AG</b> (l'"<b>émetteur</b>")  c/o Revalier Aktiengesellschaft Pradafant 11, 9490 Vaduz, Principauté de Luxembourg  Tel : +423 237 63 47  Courriel : <a href="mailto:info@awearetech.li">info@awearetech.li</a>  Le LEI est le suivant 391200PTNEZNXGJW1C39</p>
1.3	<p><b>Autorité compétente</b></p> <p><b>Autorité des marchés financiers</b> (l'"<b>AMF</b>")  Landstrasse 109, 9490 Vaduz, Principauté du Liechtenstein  Tél. : +423 236 73 73  Fax : +423 236 73 74  Courriel : <a href="mailto:info@fma-li.li">info@fma-li.li</a></p>
1.4	<p><b>Date d'approbation du prospectus</b></p> <p>05/12/2024</p>
1.5	<p><b>Avertissements</b></p>
1.5.1	<p>a) Le résumé doit être lu comme une introduction au présent prospectus. Toute décision d'investir dans les titres doit être fondée sur l'examen du prospectus dans son ensemble par l'investisseur.</p> <p>b) L'investisseur peut perdre tout ou partie du capital investi.</p> <p>c) Lorsqu'une plainte relative aux informations contenues dans le prospectus est portée devant un tribunal, l'investisseur plaignant pourrait, en vertu de la législation nationale, devoir supporter les coûts de traduction du prospectus avant l'ouverture de la procédure judiciaire.</p> <p>d) La responsabilité civile n'incombe qu'aux personnes qui ont déposé le résumé, y compris toute traduction de celui-ci, mais uniquement si le résumé est trompeur, inexact ou incohérent, lorsqu'il est lu conjointement avec les autres parties du prospectus, ou s'il ne fournit pas, lorsqu'il est lu conjointement avec les autres parties du prospectus, les informations essentielles pour aider les investisseurs à décider s'ils doivent ou non investir dans les valeurs mobilières.</p>
SECTION 2 - INFORMATIONS CLÉS SUR L'ÉMETTEUR	
2.1	<p><b>Qui est l'émetteur des titres ?</b></p>
2.1.1	<p><b>Informations sur l'émetteur</b></p> <p>a) Le nom légal et commercial de l'émetteur est "AWEARE Global AG". L'Émetteur est une société anonyme constituée dans la Principauté de Liechtenstein et régie par les lois de la Principauté de Liechtenstein. L'Émetteur a son siège social à Vaduz, Principauté du Liechtenstein et est enregistré à l'Office de la Justice / Registre du Commerce de la Principauté du Liechtenstein sous le numéro d'enregistrement FL-0002.714.015-4.</p> <p>b) L'objectif de l'émetteur est de développer et de monétiser des technologies de capteurs et d'intelligence artificielle pour les véhicules autonomes et d'autres applications.</p> <p>c) Les principaux actionnaires de l'émetteur sont :</p> <ul style="list-style-type: none"> <li>• Global Innovation Partners Limited, Îles Vierges britanniques, dont les actionnaires majoritaires sont Daniel Hyman, Mahesh Reddy, Reginald Tang et Mark Hyman.</li> </ul> <p>d) Le conseil d'administration de l'émetteur est composé de :</p> <ul style="list-style-type: none"> <li>• Dr. Daniel Hyman, Nationalité : États-Unis, adresse postale : Long Beach, Californie, États-Unis</li> <li>• Mahesh Reddy, Nationalité : États-Unis, adresse postale : Irvine, Californie, États-Unis</li> <li>• Marcel Füssinger, Nationalité : Autriche, adresse postale : 160009, Singapour</li> <li>• Revalier AG représentée par Reinhold Wohlwend, Nationalité : Liechtenstein, adresse postale : 9490, Vaduz, Liechtenstein</li> </ul> <p>e) L'auditeur est : Lucas Tihanyi, membre de l'Association des auditeurs du Liechtenstein et EXPERTsuisse, Industriering 14, 9491 Ruggell, Liechtenstein.</p>

2.2	<b>Quelles sont les principales informations financières concernant l'émetteur ?</b>																																				
2.2.1	<p>L'émetteur a été fondé le 30/11/2023 par inscription au registre du commerce de la Principauté du Liechtenstein. Selon la déclaration du Conseil d'administration en date du 25 octobre 2023, l'émetteur n'est pas soumis à un audit ordinaire et ne fait pas l'objet d'un examen d'audit. Toutefois, les états financiers annuels au 31 décembre 2023 et les états financiers intermédiaires au 15 juillet 2023 ont été vérifiés par le commissaire aux comptes.</p> <p>Les informations financières clés suivantes ont été préparées conformément aux dispositions de la loi liechtensteinoise sur les personnes et les sociétés (PCL), en particulier les articles 1024 et suivants. 1024 et suivants.</p> <p style="text-align: center;"><b>Compte de résultat</b></p> <table border="1" style="margin-left: auto; margin-right: auto;"> <thead> <tr> <th></th> <th style="text-align: center;">31/12/2023</th> <th style="text-align: center;">15/07/2024</th> </tr> </thead> <tbody> <tr> <td><b>Recettes totales</b></td> <td style="text-align: center;">0 USD</td> <td style="text-align: center;">0 USD</td> </tr> <tr> <td><b>Résultat d'exploitation</b></td> <td style="text-align: center;">USD -2'473.03</td> <td style="text-align: center;">USD -30'150.54</td> </tr> <tr> <td><b>Bénéfice net/perte nette</b></td> <td style="text-align: center;">USD -2'473.03</td> <td style="text-align: center;">USD -30'150.54</td> </tr> </tbody> </table> <p style="text-align: center;"><b>Bilan</b></p> <table border="1" style="margin-left: auto; margin-right: auto;"> <thead> <tr> <th></th> <th style="text-align: center;">31/12/2023</th> <th style="text-align: center;">15/07/2024</th> </tr> </thead> <tbody> <tr> <td><b>Total des actifs</b></td> <td style="text-align: center;">50'184.35 USD</td> <td style="text-align: center;">USD 75'244.30</td> </tr> <tr> <td><b>Total des capitaux propres</b></td> <td style="text-align: center;">47 526,97 USD</td> <td style="text-align: center;">19'849.46 USD</td> </tr> <tr> <td><b>Dette financière nette (dette à long terme plus dette à court terme moins trésorerie)</b></td> <td style="text-align: center;">0 USD</td> <td style="text-align: center;">0 USD</td> </tr> </tbody> </table> <p style="text-align: center;"><b>Tableau des flux de trésorerie</b></p> <table border="1" style="margin-left: auto; margin-right: auto;"> <thead> <tr> <th></th> <th style="text-align: center;">31/12/2023</th> <th style="text-align: center;">15/07/2024</th> </tr> </thead> <tbody> <tr> <td><b>Flux de trésorerie nets pertinents provenant des activités d'exploitation</b></td> <td style="text-align: center;">0 USD</td> <td style="text-align: center;">0 USD</td> </tr> <tr> <td><b>Flux de trésorerie nets pertinents provenant des activités d'investissement</b></td> <td style="text-align: center;">0 USD</td> <td style="text-align: center;">0 USD</td> </tr> <tr> <td><b>Net pertinent Flux de trésorerie provenant des activités de financement</b></td> <td style="text-align: center;">0 USD</td> <td style="text-align: center;">0 USD</td> </tr> </tbody> </table> <p>Les perspectives de l'Émetteur ne se sont pas détériorées de manière significative depuis la date du bilan intermédiaire au 15/07/2024. Il n'y a pas eu de changements significatifs dans la situation financière ou commerciale de l'Émetteur depuis la date de clôture du bilan intermédiaire au 15/07/2024.</p>		31/12/2023	15/07/2024	<b>Recettes totales</b>	0 USD	0 USD	<b>Résultat d'exploitation</b>	USD -2'473.03	USD -30'150.54	<b>Bénéfice net/perte nette</b>	USD -2'473.03	USD -30'150.54		31/12/2023	15/07/2024	<b>Total des actifs</b>	50'184.35 USD	USD 75'244.30	<b>Total des capitaux propres</b>	47 526,97 USD	19'849.46 USD	<b>Dette financière nette (dette à long terme plus dette à court terme moins trésorerie)</b>	0 USD	0 USD		31/12/2023	15/07/2024	<b>Flux de trésorerie nets pertinents provenant des activités d'exploitation</b>	0 USD	0 USD	<b>Flux de trésorerie nets pertinents provenant des activités d'investissement</b>	0 USD	0 USD	<b>Net pertinent Flux de trésorerie provenant des activités de financement</b>	0 USD	0 USD
	31/12/2023	15/07/2024																																			
<b>Recettes totales</b>	0 USD	0 USD																																			
<b>Résultat d'exploitation</b>	USD -2'473.03	USD -30'150.54																																			
<b>Bénéfice net/perte nette</b>	USD -2'473.03	USD -30'150.54																																			
	31/12/2023	15/07/2024																																			
<b>Total des actifs</b>	50'184.35 USD	USD 75'244.30																																			
<b>Total des capitaux propres</b>	47 526,97 USD	19'849.46 USD																																			
<b>Dette financière nette (dette à long terme plus dette à court terme moins trésorerie)</b>	0 USD	0 USD																																			
	31/12/2023	15/07/2024																																			
<b>Flux de trésorerie nets pertinents provenant des activités d'exploitation</b>	0 USD	0 USD																																			
<b>Flux de trésorerie nets pertinents provenant des activités d'investissement</b>	0 USD	0 USD																																			
<b>Net pertinent Flux de trésorerie provenant des activités de financement</b>	0 USD	0 USD																																			
2.3	<b>Quels sont les principaux risques propres à l'émetteur ?</b>																																				
2.3.1	<p><b>Faible capital</b></p> <p>L'objet de l'émetteur est la commercialisation de la technologie d'AWEARE. Le capital social de l'Émetteur est limité à 50.000,00 USD, le capital minimum requis par la loi du Liechtenstein étant de 50.000,00 USD. L'Émetteur ayant été constitué le 30/11/2023, aucune donnée financière historique significative ni aucun chiffre clé, autres que les informations financières historiques mentionnées à la section 2.2.1 du présent résumé, ne sont disponibles pour évaluer la situation financière de l'Émetteur par rapport aux années passées. L'émetteur n'est pas soumis à un audit ordinaire et ne fait pas l'objet d'une revue d'audit. L'émetteur n'a pas été évalué par une agence de notation. Un faible niveau de fonds propres représente un risque accru pour l'investisseur, car la fonction de capital de garantie est réduite d'autant.</p>																																				

	<p><b>Risque d'insolvabilité</b> En cas d'ouverture d'une procédure d'insolvabilité sur les actifs de l'émetteur, l'émetteur sera temporairement ou définitivement limité dans la cession de ses actifs, ou la cession des actifs de l'émetteur sera prise en charge par un administrateur d'insolvabilité nommé par le tribunal. Cela peut avoir un impact négatif sur la situation financière et les activités commerciales de l'émetteur. Ce cas peut se produire même si les demandes d'insolvabilité ont été déposées de manière incorrecte. En cas d'insolvabilité de l'émetteur, les participants sont responsables de leur capital investi. Le capital investi doit être traité comme des fonds propres et est donc subordonné de manière qualifiée.</p> <p><b>Financement des entreprises</b> Il n'y a pas de capital minimum à lever. Il n'y a pas de garantie de placement, mais plutôt le risque que les AWEARE Global Tokens ne soient pas entièrement souscrits (risque de placement). Si l'Émetteur ne parvient pas à solliciter le volume d'émission souhaité, l'Émetteur pourra investir moins. Il existe un risque de manque de capital pour l'émetteur. En outre, les coûts d'émission, qui sont indépendants du montant du capital levé, subsisteront, ce qui augmentera le ratio de dépenses par rapport au capital d'investissement total levé. Dans ce cas, l'émetteur risque de ne pas atteindre les objectifs d'investissement prévus et de ne pas être en mesure de remplir ses obligations au titre des jetons AWEARE Global Tokens.</p> <p><b>Gestion, technologie, dépendance à l'égard de prestataires de services tiers, concurrence et délais de développement</b> L'un des principaux atouts de l'émetteur est son utilisation astucieuse de la technologie radar la plus récente. Cependant, les avantages techniques dans l'industrie des technologies de l'information et de la communication peuvent être de courte durée. Par conséquent, le succès de l'émission dépendra en partie de sa capacité à gérer et à développer les services de l'émetteur, à accroître la base d'utilisateurs de son activité et donc à générer des revenus en réponse à l'évolution des technologies, aux demandes des utilisateurs et des fournisseurs de services tiers et aux pressions concurrentielles. Un échec ou un retard dans ce domaine pourrait avoir un impact négatif sur le succès de l'émetteur.</p> <p><b>Erreur humaine avec les contrats intelligents</b> L'Émetteur n'assume aucune responsabilité et ne fait aucune déclaration ou garantie quant à la fonctionnalité du projet de l'Émetteur ou de tout contrat intelligent pouvant être programmé ou utilisé pour le règlement de l'offre conformément au présent Prospectus au sens large. Les investisseurs peuvent subir des dépréciations en conséquence ou généralement faire face à une perte totale. Toutefois, dans de tels scénarios, des mécanismes juridiques peuvent s'appliquer pour protéger un investisseur contre les pertes.</p>
<b>SECTION 3 - INFORMATIONS ESSENTIELLES SUR LES TITRES</b>	
3.1	<b>Quelles sont les principales caractéristiques des titres ?</b>
3.1.1	<b>Informations sur les titres</b>
a)	<p><b>Description du type et de la catégorie des titres</b></p> <p>Les <b>1'400'000</b> nouveaux bons de participation offerts publiquement par l'émetteur sont des bons de participation au porteur sans droit de vote, chacun d'une valeur nominale de <b>0,01 USD</b> du capital de participation (les "<b>AWEARE Global Tokens</b>"), issus d'une nouvelle émission de capital de participation décidée par une assemblée générale extraordinaire le 18/07/2024. Les détenteurs de AWEARE Global Tokens sont appelés "<b>Participants</b>" ou "<b>Tokenholders</b>".</p>
b)	<p><b>Monnaie d'émission des titres</b></p> <p>Dollar des États-Unis ("<b>USD</b>" ou "\$"). La durée du jeton AWEARE Global est illimitée.</p>
c)	<p><b>Description des droits attachés aux titres</b></p> <p><b>Droit de vote</b> Les AWEARE Global Tokens sont des certificats de participation sans droit de vote et ne permettent pas au participant de voter, de convoquer et de participer à l'assemblée générale de l'émetteur. En outre, les AWEARE Global Tokens n'accordent pas le droit à l'information, le droit d'inspection et le droit de faire une demande. Cependant, une demande écrite d'information, d'inspection ou d'initiation d'un audit officiel peut être soumise à l'Assemblée générale.</p> <p><b>Avis de convocation et résolutions de l'assemblée générale</b> Les participants doivent être informés de la convocation de l'assemblée générale ainsi que des points à l'ordre du jour et des propositions. Chaque résolution de l'assemblée générale doit être mise à la disposition des participants au siège de l'émetteur pour qu'ils puissent la consulter sans délai. Les participants en sont informés dans l'avis de convocation.</p> <p><b>Droit au dividende et part du produit de la liquidation</b> Les AWEARE Global Tokens donnent droit à des dividendes complets à partir de la date d'acquisition valide et donnent droit à leurs détenteurs à une part du produit de liquidation proportionnellement à leur participation au capital de participation. L'émetteur ne prévoit pas actuellement de distribuer des dividendes dans un avenir proche. Bien que les statuts prévoient un droit aux dividendes, aucune prévision n'est faite quant aux distributions futures de dividendes.</p>

		<p>L'émetteur a l'intention de réinvestir les bénéfices dans la poursuite de la croissance et du développement de l'entreprise.</p> <p><b>Forme et titrisation</b> Les jetons AWEARE Global seront émis en tant que jetons. Les jetons sont des droits de valeur qui sont émis sur une base de données décentralisée (Blockchain) et qui y sont transférés. La blockchain utilisée à cette fin est la blockchain Ethereum.</p> <p><b>Exclusion des droits de souscription et de participation</b> Jusqu'à ce que le capital de participation cible de 50 000 USD soit atteint, les droits préférentiels prévus aux articles 304d, 304f et 304g de la LCP, en particulier les droits de souscription et les droits de participation des participants, sont exclus.</p> <p><b>Transférabilité des titres</b> Le transfert (tel que le transfert au sens strict, le nantissement, l'héritage) des jetons AWEARE Global Tokens nécessite l'approbation du conseil d'administration de l'émetteur. La transférabilité est donc limitée dans une certaine mesure. Dans tous les cas, un transfert de jetons globaux AWEARE n'est pas autorisé s'ils sont alors détenus par une personne dans un pays dans lequel les jetons globaux AWEARE ne peuvent pas être offerts. Un transfert au sens ci-dessus est également réputé se produire si un détenteur de tokens déplace son lieu de résidence dans un pays dans lequel les tokens globaux AWEARE ne peuvent pas être proposés.</p>
d)	<b>Rang relatif des titres dans la structure du capital de l'émetteur en cas d'insolvabilité</b>	En cas d'insolvabilité de l'émetteur, les participants sont responsables avec leur capital investi. Le capital investi doit être traité comme des fonds propres et est donc subordonné de manière qualifiée.
e)	<b>Description de la politique de dividende</b>	Aucun dividende n'a été versé à ce jour. L'émetteur ne fait pas de prévisions ou d'estimations de bénéfices et ne décrit donc pas sa politique en matière de dividendes. Les dividendes, le cas échéant, seront payés en USD. L'émetteur se réserve le droit de payer les dividendes également dans une autre devise ou crypto-monnaie. Toute résolution de verser des dividendes sera prise conformément à la loi applicable et dépendra, entre autres, des résultats d'exploitation, de la situation financière, des restrictions contractuelles et des besoins en capitaux de l'Émetteur. En tout état de cause, 5% du bénéfice net sera affecté aux réserves statutaires jusqu'à ce que celles-ci atteignent le montant de 10% du capital social libéré.
<b>3.2</b>	<b>Où les titres seront-ils négociés ?</b>	
<b>3.2.1</b>	Les AWEARE Global Tokens ne sont pas admis à la négociation sur un marché réglementé. L'émetteur se réserve le droit de demander l'admission à la négociation sur un marché réglementé.	
<b>3.4</b>	<b>Quels sont les principaux risques spécifiques aux titres ?</b>	
<b>3.4.1</b>	<p><b>Portefeuille de l'investisseur et risque lié à la clé privée</b> L'investisseur supporte seul le risque lié à la sélection du portefeuille ou à l'emplacement de la clé privée. Si un portefeuille incompatible est utilisé ou si la clé privée est perdue, l'accès aux jetons AWEARE Global Tokens est normalement impossible. Les conséquences, telles que la perte totale de l'investissement, doivent être supportées uniquement par l'investisseur.</p> <p><b>Risque de vente, de liquidité et de réalisation</b> Il n'y a aucune certitude qu'un marché liquide se développera pour les AWEARE Global Tokens. Par conséquent, les AWEARE Global Tokens ne pourraient pas être vendus sur un marché secondaire, ce qui créerait un risque de liquidité pour l'investisseur.</p> <p><b>Risque de volatilité</b> Il existe des risques liés à la volatilité du cours de l'action. Si les jetons AWEARE Global devaient être vendus et qu'ils étaient pris dans une forte fluctuation à la baisse du prix, le détenteur du jeton pourrait subir des pertes, dont certaines pourraient être substantielles, à la suite de la vente.</p> <p><b>Perte de jetons</b> Les tokens peuvent être perdus ou devenir inaccessibles, en particulier si le détenteur de tokens perd la clé privée respective pour disposer de ses tokens AWEARE Global ou en raison d'un dysfonctionnement du portefeuille électronique dans lequel les tokens AWEARE Global sont stockés. Cela pourrait entraîner la perte des Tokens. Il est de la seule responsabilité des détenteurs de Tokens de conserver et de protéger en toute sécurité la clé privée qui permet d'accéder au portefeuille électronique. Les Tokens peuvent également devenir inaccessibles en cas de décès d'un Tokenholder si celui-ci n'a pas pris de dispositions en ce sens. Ni l'émetteur ni aucun autre organisme ou institution ne sera en mesure de rétablir l'accès au portefeuille du détenteur de tokens pour les successeurs de ce dernier. La perte des clés privées pourrait en outre réduire la disponibilité de diverses fonctionnalités de la STO et des AWEARE Global Tokens. En particulier, il pourrait être impossible d'émettre des AWEARE Global Tokens</p>	

	<p>aux souscripteurs ou de les rendre transférables, auquel cas ils resteraient inutilisés indéfiniment. En outre, il pourrait être impossible de verser des dividendes. Enfin, il existe un risque qu'un attaquant frappe des AWEARE Global Tokens pour des adresses non contributives, modifie le statut de confirmation, contribue à des montants incontrôlés à la STO ou permette à l'attaquant de retirer des paiements de dividendes non réclamés.</p> <p><b>Droits limités des détenteurs de tokens</b>  Les AWEARE Global Tokens sont des certificats de participation sans droit de vote et ne permettent pas aux détenteurs de tokens de voter, de convoquer et de participer à l'assemblée générale de l'émetteur. En outre, les AWEARE Global Tokens ne confèrent pas le droit à l'information, le droit d'inspection et le droit d'introduire une demande. L'assemblée générale de l'émetteur peut donc adopter des résolutions susceptibles de porter atteinte aux droits des détenteurs de tokens. Les Tokenholders n'ont aucune possibilité de contrôler l'utilisation du produit de l'émission des AWEARE Global Tokens. Le transfert (tel que le transfert au sens strict, le nantissement, l'héritage) des AWEARE Global Tokens nécessite l'approbation du conseil d'administration de l'émetteur. Dans tous les cas, un transfert d'AWEARE Global Tokens n'est pas autorisé s'ils sont alors détenus par une personne dans un pays dans lequel les AWEARE Global Tokens ne peuvent pas être offerts. Un transfert au sens ci-dessus est également réputé se produire si un détenteur de tokens déplace son lieu de résidence dans un pays dans lequel les tokens globaux AWEARE ne peuvent pas être proposés. Le droit de souscription statutaire des détenteurs de tokens en cas d'augmentation de capital dans le cadre de cette offre est exclu.</p> <p>Les droits des détenteurs de jetons sont subordonnés Les droits des détenteurs de jetons de réclamer et de recevoir des paiements de dividendes de l'émetteur sont subordonnés aux droits de tous les détenteurs d'obligations non subordonnées de l'émetteur. En cas de liquidation de l'émetteur, les détenteurs de jetons ne seront payés que si et après que toutes les obligations de premier rang de l'émetteur ont été acquittées.</p>
<b>SECTION 4 - INFORMATIONS CLÉS SUR L'OFFRE DE VALEURS MOBILIÈRES AU PUBLIC</b>	
4.1	<b>Dans quelles conditions et selon quel calendrier puis-je investir dans ce titre ?</b>
<p><b>Pays dans lesquels les titres sont offerts</b>  L'offre consiste en des offres publiques dans les pays suivants : Allemagne, Autriche, Belgique, Bulgarie, Chypre, Croatie, Danemark, Espagne, Estonie, Finlande, France, Grèce, Hongrie, Irlande, Islande, Italie, Lettonie, Liechtenstein, Lituanie, Luxembourg, Malte, Norvège, Pays-Bas, Pologne, Portugal, République tchèque, Roumanie, Slovaquie, Slovénie, Suède, Suisse, ainsi qu'en des placements privés dans certaines juridictions en dehors de ces pays.</p> <p><b>Pays dans lesquels les titres ne sont pas offerts</b>  Les jetons AWEARE Global Tokens de l'émetteur ne sont pas et ne seront pas enregistrés en vertu des dispositions du United States Securities Act de 1933, tel que modifié, ou auprès des autorités de réglementation des valeurs mobilières de tout État des États-Unis d'Amérique, ou en Australie, au Japon ou au Canada. En conséquence, ils ne seront pas offerts, vendus ou livrés directement ou indirectement au public, sauf en vertu d'une exemption aux exigences d'enregistrement. En particulier, ce Prospectus ne constitue pas une offre de vente ou la sollicitation d'une offre d'achat des jetons AWEARE Global aux États-Unis d'Amérique, en Australie, au Japon et au Canada et ne peut pas y être distribué. En outre, ce Prospectus ne constitue pas une offre de vente ou la sollicitation d'une offre d'achat de Tokens globaux AWEARE en Russie, en Iran, en Corée du Nord, en Biélorussie, en Syrie ou dans l'un de leurs territoires. Il ne peut être distribué dans ces pays.</p> <p><b>Enchères</b>  Le processus de souscription des jetons AWEARE Global se déroulera en ligne sur le site <a href="https://kyc.awaretech.li/">https://kyc.awaretech.li/</a> (le "tableau de bord").</p> <p><b>Période de l'offre</b>  La période pendant laquelle les investisseurs peuvent soumettre leurs offres d'achat de jetons AWEARE Global Tokens commencera à la date d'approbation du prospectus et se terminera un an plus tard (la "période d'offre"). Le dernier jour de la période d'offre, les offres peuvent être faites jusqu'à 12h00, heure du Liechtenstein.</p> <p><b>Prix de l'offre</b>  Le prix d'offre d'un jeton AWEARE est de <b>12,00 USD</b> (le "prix d'offre").</p> <p>Afin d'encourager les investissements précoces, les réductions suivantes sont disponibles :</p> <p>Pour les investissements compris entre 10 000 USDC et 49 999,99 USDC, les investisseurs bénéficieront d'une remise de 10 %, ce qui rendra le prix du jeton AWEARE à 10,80 USD.</p> <p>Pour les investissements de 50 000 USDC ou plus, les investisseurs recevront un rabais de 15%, ce qui rend le prix du jeton AWEARE à 10,20 USD.</p> <p><b>Disponibilité des remises</b>  Les remises susmentionnées sont disponibles <b>jusqu'à ce que l'un des événements suivants se produise, selon ce qui se produit en premier</b> :</p> <ul style="list-style-type: none"> <li>● <b>atteindre un volume d'investissement total de 5 000 000 USDC, ou</b></li> <li>● <b>expiration de trois mois à compter du début de l'offre.</b></li> </ul> <p><b>Livraison et règlement</b></p>	

Chaque investisseur doit compléter le processus de souscription en ligne sur le tableau de bord. Les AWEARE Global Tokens seront attribués hors chaîne sous la forme d'un enregistrement dans la base de données de l'émetteur, qui peut être consulté sur le tableau de bord, contre le paiement du prix de l'offre. Les AWEARE Global Tokens seront alloués on-chain dans le Smart Contract au plus tard dans les deux mois suivant la fin de la période d'offre. Une fois que l'offre totale de AWEARE Global Tokens (après avoir atteint le capital de participation cible) a pris fin et que l'Émetteur a décidé de finaliser le Smart Contract, les AWEARE Global Tokens seront livrés dans le crypto wallet de l'investisseur.

#### Dilution

Le droit de souscription statutaire de tous les participants étant exclu en cas d'augmentation de capital dans le cadre de cette offre, les participants à cette offre ne seront pas dilués.

#### Total du produit net et des frais d'émission estimés

Le produit net total de l'offre de 1 400 000 AWEARE Global Tokens peut s'élever à environ **15 000 000 USD** correspondant à la mise en œuvre de la levée de fonds. Les coûts totaux prévus de l'offre s'élèvent à environ **1 500 000 USD** et seront imputés sur les produits.

<b>4.2</b>	<b>Pourquoi ce prospectus est-il produit ?</b>
<b>4.2.1</b>	<p>a) Le produit net estimé de l'émission des titres sera utilisé principalement pour la recherche et le développement et la protection de la propriété intellectuelle. Il pourrait être nécessaire de transférer jusqu'à 50 % d'un budget alloué à un autre poste si nécessaire.</p> <ul style="list-style-type: none"> <li>i) 10 % Coût de l'augmentation</li> <li>ii) 11 % Général et administratif</li> <li>iii) 41% Recherche et développement</li> <li>iv) 17% Juridique (protection globale de la propriété intellectuelle)</li> <li>v) 21% Bus Dev, Sales &amp; Marketing</li> </ul> <p>b) Les actionnaires actuels d'AWEARE Technologies Inc. et de Global Innovation Partners Limited sont Mahesh Reddy et le Dr Daniel Hyman. Mahesh Reddy et Dr. Daniel Hyman sont également administrateurs et actionnaires minoritaires de l'émetteur.</p> <p>c) Equanimity AG perçoit une commission de transaction de 3% du total des crypto-monnaies et des paiements en monnaie fiduciaire accumulés. Marcel Füssinger, qui est l'un des administrateurs de l'émetteur, est également administrateur et propriétaire d'Equanimity AG.</p> <p>d) <b>Total du produit net et des frais d'émission estimés</b> Le produit net total de l'offre de plus de 1 400 000 AWEARE Global Tokens peut s'élever à environ <b>15 000 000 USD</b> correspondant à la mise en œuvre de la levée de fonds. Les coûts totaux prévus de l'offre s'élèvent à environ <b>1 500 000 USD</b> et seront imputés sur le produit.</p> <p>e) <b>Arrangements de souscription</b> L'offre ne fait pas l'objet d'un contrat de souscription ferme. Il n'existe aucun accord en vertu duquel un preneur ferme est tenu de souscrire les jetons invendus. Par conséquent, il n'y a aucune garantie que la totalité de l'offre sera placée.</p>

## XIII. ΠΕΡΙΛΗΨΗ ΤΟΥ ΕΝΗΜΕΡΩΤΙΚΟΥ ΔΕΛΤΙΟΥ

Η παρούσα περίληψη περιέχει όλα τα στοιχεία που πρέπει να περιλαμβάνονται σε περίληψη για αυτό το είδος κινητών αξιών και εκδότη.

ΕΝΟΤΗΤΑ 1 - ΕΙΣΑΓΩΓΗ		
<b>1.1</b>	<b>Ονομασία και ISIN των τίτλων</b>	Τα <b>1.400.000</b> νέα δημόσια πιστοποιητικά συμμετοχής είναι πιστοποιητικά συμμετοχής χωρίς δικαίωμα ψήφου της AWEARE Global AG. Η ονομασία αυτών των πιστοποιητικών συμμετοχής είναι " <b>AWEARE Global Tokens</b> ". Ο ISIN είναι LI1363014385.
<b>1.2</b>	<b>Ταυτότητα και στοιχεία επικοινωνίας του εκδότη, συμπεριλαμβανομένου του αναγνωριστικού της νομικής οντότητας (LEI)</b>	<b>AWEARE Global AG</b> (ο "Εκδότης") c/o Revalier Aktiengesellschaft Pradafant 11, 9490 Vaduz, Πριγκιπάτο του Τηλ: +423 237 63 47 Ηλεκτρονικό ταχυδρομείο: info@awearetech.li Το LEI είναι: 391200PTNEZNXGJW1C39

1.3	Αρμόδια αρχή	Αρχή Χρηματοπιστωτικής Αγοράς (η "FMA") Landstrasse 109, 9490 Vaduz, Πριγκιπάτο του Λιχτενστάιν Τηλ: +423 236 73 73 Φαξ: +423 236 73 74 Ηλεκτρονικό ταχυδρομείο: <a href="mailto:info@fma-li.li">info@fma-li.li</a>						
1.4	Ημερομηνία έγκρισης του ενημερωτικού δελτίου	05/12/2024						
1.5	Προειδοποιήσεις							
1.5.1	<p>a) Η περίληψη θα πρέπει να διαβαστεί ως εισαγωγή στο παρόν Ενημερωτικό Δελτίο. Οποιαδήποτε απόφαση για επένδυση στις κινητές αξίες θα πρέπει να βασίζεται στην εξέταση του Ενημερωτικού Δελτίου στο σύνολό του από τον επενδυτή.</p> <p>b) Ο επενδυτής μπορεί να χάσει το σύνολο ή μέρος του επενδυμένου κεφαλαίου.</p> <p>c) Σε περίπτωση προσφυγής ενώπιον δικαστηρίου για αξίωση σχετικά με πληροφορίες που περιέχονται στο ενημερωτικό δελτίο, ο ενάγων επενδυτής ενδέχεται, σύμφωνα με το εθνικό δίκαιο, να πρέπει να αναλάβει το κόστος της μετάφρασης του ενημερωτικού δελτίου πριν από την έναρξη της δικαστικής διαδικασίας.</p> <p>d) Η αστική ευθύνη βαρύνει μόνο τα πρόσωπα που κατέθεσαν την περίληψη, συμπεριλαμβανομένης οποιασδήποτε μετάφρασής της, αλλά μόνο εάν η περίληψη είναι παραπλανητική, ανακριβής ή ασυνεπής, όταν διαβάζεται μαζί με τα άλλα μέρη του ενημερωτικού δελτίου ή εάν δεν παρέχει, όταν διαβάζεται μαζί με τα άλλα μέρη του ενημερωτικού δελτίου, βασικές πληροφορίες που θα βοηθήσουν τους επενδυτές να εξετάσουν αν θα επενδύσουν στις κινητές αξίες.</p>							
<b>ΕΝΟΤΗΤΑ 2 - ΒΑΣΙΚΕΣ ΠΛΗΡΟΦΟΡΙΕΣ ΓΙΑ ΤΟΝ ΕΚΔΟΤΗ</b>								
2.1	Ποιος είναι ο εκδότης των τίτλων;							
2.1.1	Πληροφορίες για τον εκδότη							
	<p>a) Η νομική και εμπορική επωνυμία του Εκδότη είναι "AWEARE Global AG". Ο εκδότης είναι ανώνυμη εταιρεία που έχει συσταθεί στο Πριγκιπάτο του Λιχτενστάιν και διέπεται από τους νόμους του Πριγκιπάτου του Λιχτενστάιν. Η Εκδότρια έχει την καταστατική της έδρα στο Vaduz, Πριγκιπάτο του Λιχτενστάιν και είναι εγγεγραμμένη στο Γραφείο Δικαιοσύνης / Εμπορικό Μητρώο του Πριγκιπάτου του Λιχτενστάιν με αριθμό μητρώου FL-0002.714.015-4.</p> <p>b) Σκοπός του Εκδότη είναι να αναπτύξει και να αξιοποιήσει τεχνολογίες αισθητήρων και τεχνητής νοημοσύνης για αυτόνομα οχήματα και άλλες εφαρμογές.</p> <p>c) Οι κύριοι μέτοχοι του Εκδότη είναι: <ul style="list-style-type: none"> <li>Global Innovation Partners Limited, Βρετανικές Παρθένες Νήσοι με μετόχους πλειοψηφίας τους Dr. Daniel Hyman, Mahesh Reddy, Dr. Reginald Tang και Mark Hyman</li> </ul> </p> <p>d) Το Διοικητικό Συμβούλιο του Εκδότη αποτελείται από: <ul style="list-style-type: none"> <li>Dr. Daniel Hyman, Εθνικότητα: Hyman: Ηνωμένες Πολιτείες, Διεύθυνση αλληλογραφίας: Long Beach, Καλιφόρνια, ΗΠΑ</li> <li>Mahesh Reddy, Εθνικότητα: Rededy: Ηνωμένες Πολιτείες, Διεύθυνση αλληλογραφίας: Irvine, Καλιφόρνια, ΗΠΑ</li> <li>Marcel Füssinger, Εθνικότητα: Füssinger: Αυστρία, Διεύθυνση αλληλογραφίας: Αυστρία: 160009, Σιγκαπούρη</li> <li>Revalier AG εκπροσωπούμενη από τον Reinhold Wohlwend, Εθνικότητα: Wohlwend, Ταχυδρομική Διεύθυνση: 9490, Vaduz, Λιχτενστάιν</li> </ul> </p> <p>e) Ο ελεγκτής είναι: Lucas Thanyi, Μέλος της Ένωσης Ελεγκτών Λιχτενστάιν και EXPERTsuisse, Industriering 14, 9491 Ruggell, Λιχτενστάιν</p>							
2.2	Ποιες είναι οι βασικές οικονομικές πληροφορίες σχετικά με τον εκδότη;							
2.2.1	<p>Ο Εκδότης ιδρύθηκε στις 30/11/2023 με εγγραφή στο εμπορικό μητρώο του Πριγκιπάτου του Λιχτενστάιν. Σύμφωνα με τη δήλωση του Διοικητικού Συμβουλίου της 25ης Οκτωβρίου 2023, ο Εκδότης δεν υπόκειται σε τακτικό έλεγχο και δεν υπόκειται σε ελεγκτικό έλεγχο. Ωστόσο, οι ετήσιες οικονομικές καταστάσεις της 31ης Δεκεμβρίου 2023 και οι ενδιάμεσες οικονομικές καταστάσεις της 15ης Ιουλίου 2023 ελέγχθηκαν από τον ελεγκτή.</p> <p>Οι ακόλουθες βασικές χρηματοοικονομικές πληροφορίες έχουν καταρτιστεί σύμφωνα με τις διατάξεις του νόμου περί προσώπων και εταιρειών του Λιχτενστάιν ("PCL"), και ιδίως με το άρθρο 1 του νόμου περί προσώπων και εταιρειών του Λιχτενστάιν ("PCL"). 1024 και επόμενα.</p> <p style="text-align: center;"><b>Κατάσταση λογαριασμού αποτελεσμάτων</b></p> <table border="1" style="margin-left: auto; margin-right: auto;"> <thead> <tr> <th></th> <th>31/12/2023</th> <th>15/07/2024</th> </tr> </thead> <tbody> <tr> <td><b>Συνολικά έσοδα</b></td> <td style="text-align: center;">USD 0</td> <td style="text-align: center;">USD 0</td> </tr> </tbody> </table>			31/12/2023	15/07/2024	<b>Συνολικά έσοδα</b>	USD 0	USD 0
	31/12/2023	15/07/2024						
<b>Συνολικά έσοδα</b>	USD 0	USD 0						

Λειτουργικά κέρδη/ζημιές	USD -2'473.03	USD -30'150.54
Καθαρά κέρδη/ζημιές	USD -2'473.03	USD -30'150.54

### Ισολογισμός

	31/12/2023	15/07/2024
Σύνολο ενεργητικού	USD 50'184.35	USD 75'244.30
Σύνολο ιδίων κεφαλαίων	USD 47,526.97	USD 19'849.46
Καθαρό χρηματοοικονομικό χρέος (μακροπρόθεσμο χρέος συν βραχυπρόθεσμο χρέος μείον μετρητά)	USD 0	USD 0

### Κατάσταση ταμειακών ροών

	31/12/2023	15/07/2024
Σχετικές καθαρές ταμειακές ροές από λειτουργικές δραστηριότητες	USD 0	USD 0
Σχετικές καθαρές Ταμειακές ροές από επενδυτικές δραστηριότητες	USD 0	USD 0
Σχετικές καθαρές Ταμειακές ροές από χρηματοδοτικές δραστηριότητες	USD 0	USD 0

Οι προοπτικές του Εκδότη δεν έχουν επιδεινωθεί σημαντικά από την ημερομηνία του ενδιάμεσου ισολογισμού στις 15/07/2024. Δεν υπήρξαν σημαντικές αλλαγές στην οικονομική θέση ή την εμπορική θέση του Εκδότη από την ημερομηνία αναφοράς του ενδιάμεσου ισολογισμού στις 15/07/2024.

#### 2.3 Ποιοι είναι οι βασικοί κίνδυνοι που αφορούν ειδικά τον εκδότη;

##### Χαμηλό κεφάλαιο

Σκοπός του Εκδότη είναι η εμπορική αξιοποίηση της τεχνολογίας της AWEARE. Το μετοχικό κεφάλαιο του Εκδότη περιορίζεται σε 50.000,00 δολάρια ΗΠΑ, όπου το ελάχιστο απαιτούμενο κεφάλαιο σύμφωνα με τη νομοθεσία του Λιχτενστάιν είναι 50.000,00 δολάρια ΗΠΑ. Δεδομένου ότι ο Εκδότης συστάθηκε στις 30/11/2023, δεν υπάρχουν σημαντικά ιστορικά οικονομικά στοιχεία ή βασικά μεγέθη, εκτός από τις ιστορικές οικονομικές πληροφορίες που αναφέρονται στην ενότητα 2.2.1 της παρούσας περιλήψης, για την αξιολόγηση της οικονομικής κατάστασης του Εκδότη σε σχέση με τα προηγούμενα έτη. Ο Εκδότης δεν υπόκειται σε τακτικό έλεγχο και δεν έχει ελεγχθεί από ελεγκτή. Ο Εκδότης δεν έχει αξιολογηθεί από οργανισμό αξιολόγησης. Τα χαμηλά ίδια κεφάλαια αντιπροσωπεύουν αυξημένο κίνδυνο για τον επενδυτή, καθώς μειώνεται αντίστοιχα η λειτουργία του ως υπεύθυνο κεφάλαιο.

##### Κίνδυνος αφερεγγυότητας

2.3.1

Σε περίπτωση έναρξης διαδικασίας αφερεγγυότητας επί των περιουσιακών στοιχείων του Εκδότη, ο Εκδότης θα περιοριστεί προσωρινά ή μόνιμα στη διάθεση των περιουσιακών του στοιχείων ή η διάθεση των περιουσιακών στοιχείων του Εκδότη θα αναληφθεί από δικαστικά διορισμένο διαχειριστή αφερεγγυότητας. Αυτό ενδέχεται να έχει αρνητικό αντίκτυπο στη χρηματοοικονομική θέση και τις επιχειρηματικές δραστηριότητες του Εκδότη. Η περίπτωση αυτή μπορεί να συμβεί ακόμη και αν οι αιτήσεις αφερεγγυότητας υποβλήθηκαν εσφαλμένα. Σε περίπτωση αφερεγγυότητας του Εκδότη, οι Συμμετέχοντες ευθύνονται με το επενδεδυμένο κεφάλαιό τους. Το επενδεδυμένο κεφάλαιο πρέπει να αντιμετωπίζεται ως ίδια κεφάλαια και συνεπώς είναι ειδικώς μειωμένης εξασφάλισης.

##### Χρηματοδότηση επιχειρήσεων

Δεν υπάρχει ελάχιστο κεφάλαιο που πρέπει να συγκεντρωθεί. Δεν υπάρχει εγγύηση τοποθέτησης, αλλά ο κίνδυνος ότι τα AWEARE Global Tokens δεν θα εγγραφούν πλήρως (κίνδυνος τοποθέτησης). Εάν ο Εκδότης δεν καταφέρει να συγκεντρώσει τον επιθυμητό όγκο έκδοσης, ο Εκδότης θα μπορέσει να επενδύσει λιγότερα. Υπάρχει κίνδυνος έλλειψης κεφαλαίου για τον Εκδότη. Επιπλέον, το κόστος εκπομπής, το οποίο είναι ανεξάρτητο από το ύψος του αντληθέντος κεφαλαίου, θα παραμείνει, γεγονός που θα αυξήσει τον δείκτη εξόδων σε σχέση με το συνολικό αντληθέν επενδυτικό κεφάλαιο. Υπάρχει κίνδυνος στην περίπτωση αυτή ο Εκδότης να μην επιτύχει τους επιδιωκόμενους επενδυτικούς στόχους του και να μην είναι σε θέση να εκπληρώσει τις υποχρεώσεις του βάσει των AWEARE Global Tokens.



	<p><b>Διαχείριση, τεχνολογία, εξάρτηση από τρίτους παρόχους υπηρεσιών, ανταγωνισμός και χρονοδιαγράμματα ανάπτυξης</b></p> <p>Ένα από τα βασικά πλεονεκτήματα του Εκδότη είναι η έξυπνη χρήση της τελευταίας τεχνολογίας ραντάρ. Ωστόσο, τα τεχνικά πλεονεκτήματα στον κλάδο της τεχνολογίας πληροφοριών και επικοινωνιών μπορεί να είναι βραχύβια. Κατά συνέπεια, η επιτυχία της έκδοσης θα εξαρτηθεί εν μέρει από την ικανότητά της να διαχειρίζεται και να επεκτείνει τις υπηρεσίες της Εκδότριας και να αυξάνει τη βάση χρηστών της επιχείρησής της και, ως εκ τούτου, να παράγει έσοδα ανταποκρινόμενη στις μεταβαλλόμενες τεχνολογίες, στις απαιτήσεις των χρηστών και των τρίτων παρόχων υπηρεσιών και στις ανταγωνιστικές πιέσεις. Η αποτυχία ή οι καθυστερήσεις σε αυτό μπορεί να επηρεάσουν αρνητικά την επιτυχία του Εκδότη.</p> <p><b>Ανθρώπινο σφάλμα με έξυπνες συμβάσεις</b></p> <p>Ο Εκδότης δεν αναλαμβάνει καμία ευθύνη και δεν παρέχει καμία δήλωση ή εγγύηση όσον αφορά τη λειτουργικότητα του έργου του Εκδότη ή οποιωνδήποτε έξυπνων συμβάσεων που ενδέχεται να προγραμματιστούν ή να χρησιμοποιηθούν για τον διακανονισμό της προσφοράς σύμφωνα με το παρόν Ενημερωτικό Δελτίο με την ευρύτερη έννοια. Οι επενδυτές ενδέχεται να υποστούν απομειώσεις ως αποτέλεσμα ή γενικά να βρεθούν αντιμέτωποι με ολική απώλεια. Ωστόσο, σε τέτοια σενάρια, ενδέχεται να ισχύουν νομικοί μηχανισμοί για την προστασία ενός επενδυτή από ζημιές.</p>
<b>ΕΝΟΤΗΤΑ 3 - ΒΑΣΙΚΕΣ ΠΛΗΡΟΦΟΡΙΕΣ ΓΙΑ ΤΙΣ ΚΙΝΗΤΕΣ ΑΞΙΕΣ</b>	
3.1	Ποια είναι τα κύρια χαρακτηριστικά των τίτλων;
3.1.1	Πληροφορίες σχετικά με τους τίτλους
a)	<p><b>Περιγραφή του τύπου και της κατηγορίας των κινητών αξιών</b></p> <p>Τα <b>1.400.000</b> νέα πιστοποιητικά συμμετοχής που προσφέρονται δημοσίως από τον Εκδότη είναι πιστοποιητικά συμμετοχής χωρίς δικαίωμα ψήφου στον κομιστή, ονομαστικής αξίας <b>0,01 δολαρίων ΗΠΑ</b> του κεφαλαίου συμμετοχής (τα "<b>AWEARE Global Tokens</b>")., από νέα έκδοση κεφαλαίου συμμετοχής που αποφασίστηκε από έκτακτη γενική συνέλευση στις 18/07/2024. Οι κάτοχοι των AWEARE Global Tokens αποκαλούνται "<b>Συμμετέχοντες</b>" ή "<b>Tokenholders</b>".</p>
b)	<p><b>Νόμισμα της έκδοσης τίτλων</b></p> <p>Δολάριο Ηνωμένων Πολιτειών ("<b>USD</b>" ή "<b>\$</b>"). Η διάρκεια του AWEARE Global Token είναι απεριόριστη.</p>
c)	<p><b>Περιγραφή των δικαιωμάτων που απορρέουν από τους τίτλους</b></p> <p><b>Δικαίωμα ψήφου</b> Τα AWEARE Global Tokens είναι πιστοποιητικά συμμετοχής χωρίς δικαίωμα ψήφου και δεν παρέχουν στον Συμμετέχοντα το δικαίωμα να ψηφίζει, να συγκαλεί και να συμμετέχει στη Γενική Συνέλευση του Εκδότη. Επιπλέον, τα AWEARE Global Tokens δεν παρέχουν το δικαίωμα πληροφόρησης, το δικαίωμα επιθεώρησης και το δικαίωμα υποβολής αίτησης. Ωστόσο, στη Γενική Συνέλευση μπορεί να υποβληθεί γραπτή αίτηση για πληροφορίες ή επιθεώρηση ή για την έναρξη επίσημου ελέγχου.</p> <p><b>Ανακοίνωση της σύγκλησης και των αποφάσεων της γενικής συνέλευσης</b> Οι συμμετέχοντες πρέπει να ενημερώνονται για τη σύγκληση της γενικής συνέλευσης μαζί με τα θέματα της ημερήσιας διάταξης και τις προτάσεις. Κάθε απόφαση της Γενικής Συνέλευσης πρέπει να διατίθεται για επιθεώρηση από τους συμμετέχοντες στην έδρα του Εκδότη χωρίς καθυστέρηση. Οι Συμμετέχοντες ενημερώνονται σχετικά στην πρόσκληση.</p> <p><b>Δικαίωμα μερίσματος και μερίδιο από το προϊόν της εκκαθάρισης</b> Τα AWEARE Global Tokens παρέχουν πλήρη δικαιώματα μερίσματος από την ημερομηνία έγκυρης απόκτησης και παρέχουν στους κατόχους τους δικαίωμα σε μερίδιο από το προϊόν της εκκαθάρισης ανάλογα με τη συμμετοχή τους στο κεφάλαιο συμμετοχής. Ο Εκδότης δεν σχεδιάζει επί του παρόντος να διανείμει μερίσματα στο εγγύς μέλλον. Παρόλο που βάσει του καταστατικού υφίσταται αξίωση για μερίσματα, δεν γίνονται προβλέψεις σχετικά με μελλοντικές διανομές μερισμάτων. Ο Εκδότης σκοπεύει να επανεπενδύσει τα κέρδη στην περαιτέρω ανάπτυξη και εξέλιξη της εταιρείας.</p> <p><b>Μορφή και τιλοποίηση</b> Τα AWEARE Global Tokens θα εκδοθούν ως μάρκες. Τα Tokens είναι δικαιώματα αξίας που εκδίδονται σε μια αποκεντρωμένη βάση δεδομένων (Blockchain) και μεταφέρονται εκεί. Το Blockchain που χρησιμοποιείται για τον σκοπό αυτό είναι το Ethereum Blockchain.</p> <p><b>Αποκλεισμός των δικαιωμάτων εγγραφής και των δικαιωμάτων συμμετοχής</b> Έως ότου επιτευχθεί ο στόχος του κεφαλαίου συμμετοχής των 50.000 δολαρίων ΗΠΑ, αποκλείονται τα προνομιακά δικαιώματα σύμφωνα με τα άρθρα 304δ, 304στ και 304ζ του ΠΚΚ, ιδίως τα δικαιώματα εγγραφής και τα δικαιώματα συμμετοχής των συμμετεχόντων.</p> <p><b>Μεταβιβασιμότητα των τίτλων</b></p>

		<p>Η μεταβίβαση (όπως μεταβίβαση με τη στενή έννοια, ενεχυρίαση, κληρονομιά) των AWEARE Global Tokens απαιτεί την έγκριση του Διοικητικού Συμβουλίου του Εκδότη. Συνεπώς, η δυνατότητα μεταβίβασης περιορίζεται σε ορισμένο βαθμό. Σε κάθε περίπτωση, δεν επιτρέπεται η μεταβίβαση των AWEARE Global Tokens εάν αυτά θα κατέχονταν στη συνέχεια από πρόσωπο σε χώρα στην οποία δεν επιτρέπεται να προσφέρονται AWEARE Global Tokens. Μεταβίβαση με την ανωτέρω έννοια θεωρείται επίσης ότι πραγματοποιείται εάν ο κάτοχος Token μεταφέρει τον τόπο κατοικίας του σε χώρα στην οποία δεν επιτρέπεται να προσφέρονται AWEARE Global Tokens.</p>
d)	<b>Σχετική προτεραιότητα των τίτλων στην κεφαλαιακή διάρθρωση του εκδότη σε περίπτωση αφερεγγυότητας</b>	<p>Σε περίπτωση αφερεγγυότητας του Εκδότη, οι Συμμετέχοντες ευθύνονται με το επενδεδυμένο κεφάλαιό τους. Το επενδεδυμένο κεφάλαιο πρέπει να αντιμετωπίζεται ως ίδια κεφάλαια και συνεπώς είναι ειδικώς μειωμένης εξασφάλισης.</p>
e)	<b>Περιγραφή της μερισματικής πολιτικής</b>	<p>Μέχρι σήμερα δεν έχουν καταβληθεί μερίσματα. Ο Εκδότης δεν προβλέπει σε προβλέψεις ή εκτιμήσεις κερδών και ως εκ τούτου δεν γίνεται περιγραφή της μερισματικής πολιτικής. Τα μερίσματα, εάν υπάρξουν, θα καταβληθούν σε δολάρια ΗΠΑ. Ο Εκδότης διατηρεί το δικαίωμα να καταβάλει μερίσματα και σε άλλο νόμισμα ή κρυπτονόμισμα. Οποιαδήποτε απόφαση για την καταβολή μερισμάτων θα λαμβάνεται σύμφωνα με την ισχύουσα νομοθεσία και θα εξαρτάται, μεταξύ άλλων, από τα αποτελέσματα των εργασιών, την οικονομική κατάσταση, τους συμβατικούς περιορισμούς και τις κεφαλαιακές ανάγκες του Εκδότη. Σε κάθε περίπτωση, το 5% των καθαρών κερδών θα διατεθεί στα υποχρεωτικά αποθεματικά, έως ότου αυτά φθάσουν στο ποσό του 10% του καταβεβλημένου μετοχικού κεφαλαίου.</p>
<b>3.2</b>	<b>Πού θα αποτελούν αντικείμενο διαπραγμάτευσης οι κινητές αξίες;</b>	
<b>3.2.1</b>	<p>Τα AWEARE Global Tokens δεν είναι εισηγμένα για διαπραγμάτευση σε ρυθμιζόμενη αγορά. Ο Εκδότης διατηρεί το δικαίωμα να υποβάλει αίτηση για εισαγωγή προς διαπραγμάτευση σε ρυθμιζόμενη αγορά.</p>	
<b>3.4</b>	<b>Ποιοι είναι οι βασικοί κίνδυνοι που αφορούν τους τίτλους;</b>	
<b>3.4.1</b>	<p><b>Κίνδυνος πορτοφολιού επενδυτών και ιδιωτικού κλειδιού</b>  Ο επενδυτής φέρει μόνος του τον κίνδυνο της επιλογής του πορτοφολιού ή της τοποθεσίας του ιδιωτικού κλειδιού. Εάν χρησιμοποιηθεί ασύμβατο πορτοφόλι ή εάν χαθεί το ιδιωτικό κλειδί, η πρόσβαση στα AWEARE Global Tokens είναι συνήθως αδύνατη. Οι συνέπειες, όπως η πλήρης απώλεια της επένδυσης, πρέπει να βαρύνουν αποκλειστικά τον επενδυτή.</p> <p><b>Κίνδυνος εμπορευσιμότητας, ρευστότητας και ρευστοποίησης</b>  Δεν είναι βέβαιο ότι θα αναπτυχθεί ρευστή αγορά για τα AWEARE Global Tokens. Ως αποτέλεσμα, τα AWEARE Global Tokens δεν θα μπορούσαν να πωληθούν σε δευτερογενή αγορά, δημιουργώντας κίνδυνο ρευστότητας για τον επενδυτή.</p> <p><b>Κίνδυνος μεταβλητότητας</b>  Υπάρχουν κίνδυνοι σε σχέση με τη μεταβλητότητα της τιμής της μετοχής. Εάν τα AWEARE Global Tokens πωληθούν και εμπλακούν σε μια απότομη καθοδική διακύμανση της τιμής τους, ο κάτοχος Token θα μπορούσε να υποστεί απώλειες, ορισμένες από τις οποίες θα μπορούσαν να είναι σημαντικές, ως αποτέλεσμα της πώλησης.</p> <p><b>Απώλεια μάρκων</b>  Τα Token ενδέχεται να χαθούν ή να καταστούν μη προσβάσιμα, ιδίως εάν ο κάτοχος Token χάσει το αντίστοιχο ιδιωτικό κλειδί για τη διάθεση των AWEARE Global Token ή λόγω δυσλειτουργίας του ηλεκτρονικού πορτοφολιού στο οποίο είναι αποθηκευμένα τα AWEARE Global Token. Αυτό μπορεί να έχει ως αποτέλεσμα την απώλεια των Tokens. Είναι αποκλειστική ευθύνη των κατόχων Token να αποθηκεύουν και να προστατεύουν με ασφάλεια το ιδιωτικό κλειδί που επιτρέπει την πρόσβαση στο ηλεκτρονικό πορτοφόλι. Τα Token ενδέχεται να καταστούν μη προσβάσιμα και σε περίπτωση θανάτου ενός κατόχου Token, εάν δεν έχει προβεί σε ρυθμίσεις για τέτοιες περιπτώσεις. Ούτε ο Εκδότης ούτε οποιοσδήποτε άλλος φορέας ή ίδρυμα θα είναι σε θέση να αποκαταστήσει την πρόσβαση στο πορτοφόλι του κατόχου του Token για τους διαδόχους του κατόχου του Token. Η απώλεια των ιδιωτικών κλειδιών θα μπορούσε επιπλέον να μειώσει τη διαθεσιμότητα διαφόρων λειτουργιών του STO και των AWEARE Global Tokens. Ειδικότερα, ενδέχεται να είναι αδύνατο να εκδοθούν AWEARE Global Tokens σε συνδρομητές ή να καταστούν μεταβιβάσιμα, οπότε θα παρέμεναν σε παύση επ' αόριστον. Επιπλέον, ενδέχεται να είναι αδύνατη η καταβολή μερισμάτων. Τέλος, υπάρχει ο κίνδυνος ένας επιτιθέμενος να κόψει AWEARE Global Tokens για διευθύνσεις που δεν συνεισφέρουν, να αλλάξει την κατάσταση επιβεβαίωσης, να συνεισφέρει ανεξέλεγκτα ποσά στο STO ή να επιτρέψει στον επιτιθέμενο να αποσύρει μη διεκδικούμενες πληρωμές μερισμάτων.</p> <p><b>Περιορισμένα δικαιώματα των κατόχων Token</b>  Τα AWEARE Global Tokens είναι πιστοποιητικά συμμετοχής χωρίς δικαίωμα ψήφου και δεν παρέχουν στους κατόχους Token δικαίωμα ψήφου, σύγκλησης και συμμετοχής στη Γενική Συνέλευση του Εκδότη. Επιπλέον, τα AWEARE Global Tokens δεν παρέχουν το δικαίωμα πληροφόρησης, το δικαίωμα επιθεώρησης και το δικαίωμα υποβολής αίτησης. Συνεπώς, η Γενική Συνέλευση του Εκδότη ενδέχεται να λάβει αποφάσεις που ενδέχεται να επηρεάσουν δυσμενώς τα δικαιώματα των κατόχων Token. Οι κάτοχοι Token δεν έχουν τη δυνατότητα να ελέγχουν τη χρήση των εσόδων από την έκδοση των AWEARE Global Tokens. Η μεταβίβαση (όπως μεταβίβαση με τη στενή</p>	

	<p>έννοια, ενεχυρίαση, κληρονομιά) των AWEARE Global Tokens απαιτεί την έγκριση του Διοικητικού Συμβουλίου του Εκδότη. Σε κάθε περίπτωση, η μεταβίβαση των AWEARE Global Tokens δεν επιτρέπεται εάν αυτά θα βρίσκονται στη συνέχεια στην κατοχή προσώπου σε χώρα στην οποία δεν επιτρέπεται να προσφέρονται AWEARE Global Tokens. Μεταβίβαση υπό την ανωτέρω έννοια θεωρείται επίσης ότι πραγματοποιείται εάν ο κάτοχος Token μεταφέρει τον τόπο κατοικίας του σε χώρα στην οποία δεν επιτρέπεται να προσφέρονται AWEARE Global Tokens. Το νόμιμο δικαίωμα εγγραφής των κατόχων Token σε περίπτωση αύξησης κεφαλαίου στο πλαίσιο της παρούσας προσφοράς αποκλείεται.</p> <p>Τα δικαιώματα των κατόχων Token να διεκδικούν και να λαμβάνουν πληρωμές μερισμάτων από τον Εκδότη είναι κατώτερα των απαιτήσεων όλων των κατόχων μη μειωμένης εξασφάλισης υποχρεώσεων του Εκδότη. Σε περίπτωση εκκαθάρισης του Εκδότη, οι κάτοχοι των Tokenholders θα πληρωθούν μόνο εάν και αφού εξοφληθούν όλες οι υποχρεώσεις του Εκδότη που έχουν προτεραιότητα.</p>
--	--

#### ΕΝΟΤΗΤΑ 4 - ΒΑΣΙΚΕΣ ΠΛΗΡΟΦΟΡΙΕΣ ΣΧΕΤΙΚΑ ΜΕ ΤΗΝ ΠΡΟΣΦΟΡΑ ΚΙΝΗΤΩΝ ΑΞΙΩΝ ΣΤΟ ΚΟΙΝΟ

##### 4.1 Υπό ποιες προϋποθέσεις και με ποιο χρονοδιάγραμμα μπορώ να επενδύσω σε αυτό το αξιόγραφο;

###### Χώρες στις οποίες προσφέρονται οι τίτλοι

Η προσφορά περιλαμβάνει δημόσιες προσφορές στην Αυστρία, το Βέλγιο, τη Βουλγαρία, την Κροατία, την Κύπρο, την Τσεχική Δημοκρατία, τη Δανία, την Εσθονία, τη Φινλανδία, τη Γαλλία, τη Γερμανία, την Ελλάδα, την Ουγγαρία, την Ισλανδία, την Ιρλανδία, την Ιταλία, τη Λετονία, το Λιχτενστάιν, τη Λιθουανία, το Λουξεμβούργο, τη Μάλτα, τις Κάτω Χώρες, τη Νορβηγία, την Πολωνία, την Πορτογαλία, τη Ρουμανία, τη Σλοβακία, τη Σλοβενία, την Ισπανία, τη Σουηδία, την Ελβετία, καθώς και ιδιωτικές τοποθετήσεις σε ορισμένες δικαιοδοσίες εκτός αυτών.

###### Χώρες στις οποίες δεν προσφέρονται οι κινητές αξίες

Τα AWEARE Global Tokens του Εκδότη δεν είναι και δεν θα καταχωρηθούν σύμφωνα με τις διατάξεις του νόμου περί κινητών αξιών των Ηνωμένων Πολιτειών του 1933, όπως τροποποιήθηκε, ή με τις ρυθμιστικές αρχές κινητών αξιών οποιασδήποτε πολιτείας των Ηνωμένων Πολιτειών της Αμερικής, ή στην Αυστραλία, την Ιαπωνία ή τον Καναδά. Κατά συνέπεια, δεν θα προσφερθούν, πωληθούν ή παραδοθούν άμεσα ή έμμεσα στο κοινό, παρά μόνο βάσει απαλλαγής από τις απαιτήσεις καταχώρισης. Ειδικότερα, το παρόν Ενημερωτικό Δελτίο δεν συνιστά ούτε αποτελεί προσφορά πώλησης ή πρόσκληση για προσφορά αγοράς AWEARE Global Tokens στις Ηνωμένες Πολιτείες της Αμερικής, την Αυστραλία, την Ιαπωνία και τον Καναδά και δεν μπορεί να διανεμηθεί σε αυτές. Επιπλέον, το παρόν Ενημερωτικό Δελτίο δεν συνιστά ούτε συνιστά προσφορά πώλησης ή πρόσκληση για προσφορά αγοράς AWEARE Global Tokens στη Ρωσία, το Ιράν ή τη Βόρεια Κορέα, τη Λευκορωσία, τη Συρία ή σε οποιαδήποτε περιοχή τους. Και δεν μπορεί να διανεμηθεί εκεί.

###### Πλειοδοσία

Η διαδικασία εγγραφής για τα AWEARE Global Tokens θα πραγματοποιείται ηλεκτρονικά στη διεύθυνση <https://kyc.awearetech.li/> (το "Dashboard").

###### Περίοδος προσφοράς

Η περίοδος κατά τη διάρκεια της οποίας οι επενδυτές μπορούν να υποβάλουν τις προσφορές τους για την αγορά των AWEARE Global Tokens θα αρχίσει από την ημερομηνία έγκρισης του Ενημερωτικού Δελτίου και θα λήξει ένα έτος αργότερα ("Περίοδος Προσφοράς"). Την τελευταία ημέρα της Περιόδου Προσφοράς, οι προσφορές μπορούν να υποβληθούν μέχρι τις 12:00 το μεσημέρι ώρα Λιχτενστάιν.

###### Τιμή προσφοράς

Η τιμή προσφοράς ενός AWEARE Token είναι **12,00 USD** (η "Τιμή Προσφοράς").

Για την ενθάρρυνση της έγκαιρης επένδυσης, διατίθενται οι ακόλουθες εκπτώσεις:

Για επενδύσεις μεταξύ 10.000 USDC και 49.999,99 USDC, οι επενδυτές θα λάβουν έκπτωση 10%, καθιστώντας την τιμή ανά AWEARE Token 10,80 USD.

Για επενδύσεις ύψους 50.000 USDC ή περισσότερο, οι επενδυτές θα λάβουν έκπτωση 15%, με αποτέλεσμα η τιμή ανά AWEARE Token να είναι 10,20 USD.

###### Διαθεσιμότητα των εκπτώσεων

Οι παραπάνω εκπτώσεις είναι διαθέσιμες έως ότου συμβεί ένα από τα ακόλουθα, όποιο από τα δύο συμβεί πρώτο:

- να φθάσει σε συνολικό όγκο επενδύσεων **5.000.000 USDC**, ή
- λήξη τριών μηνών από την έναρξη της προσφοράς.

###### Παράδοση και διακανονισμός

Κάθε επενδυτής πρέπει να ολοκληρώσει τη διαδικασία ηλεκτρονικής εγγραφής στο Dashboard. Τα AWEARE Global Tokens θα διατεθούν εκτός αλυσίδας ως εγγραφή στη βάση δεδομένων του Εκδότη, η οποία μπορεί να είναι ορατή μέσω του Dashboard, έναντι πληρωμής της τιμής προσφοράς. Τα AWEARE Global Tokens θα κατανεμηθούν on-chain στο Smart Contract το αργότερο εντός δύο μηνών από τη λήξη της Περιόδου Προσφοράς. Μόλις λήξει η συνολική προσφορά των AWEARE Global Tokens (μετά την επίτευξη του στοχευόμενου κεφαλαίου συμμετοχής) και ο Εκδότης αποφασίσει να οριστικοποιήσει το Smart Contract, τα AWEARE Global Tokens θα παραδοθούν στο κρυπτογραφικό πορτοφόλι του επενδυτή.

###### Αραιώση

Δεδομένου ότι το νόμιμο δικαίωμα εγγραφής όλων των συμμετεχόντων αποκλείεται σε περίπτωση αύξησης κεφαλαίου στο πλαίσιο της παρούσας προσφοράς, οι συμμετέχοντες στην παρούσα προσφορά δεν θα αποδυναμωθούν.

#### Συνολικά καθαρά έσοδα και εκτιμώμενο κόστος έκδοσης

Τα συνολικά καθαρά έσοδα από την προσφορά πάνω από 1.400.000 AWEARE Global Tokens μπορεί να ανέλθουν σε περίπου **15.000.000 δολάρια ΗΠΑ** που αντιστοιχούν στην υλοποίηση της αύξησης κεφαλαίου. Το αναμενόμενο συνολικό κόστος της προσφοράς ανέρχεται σε περίπου **1.500.000 USD** και θα χρεωθεί από τα έσοδα.

<b>4.2</b>	<b>Γιατί συντάσσεται αυτό το ενημερωτικό δελτίο;</b>
<b>4.2.1</b>	<p>a) Τα εκτιμώμενα καθαρά έσοδα από την έκδοση των τίτλων θα χρησιμοποιηθούν κυρίως για έρευνα και ανάπτυξη και προστασία της πνευματικής ιδιοκτησίας. Ενδέχεται να χρειαστεί να μετατοπιστεί έως και το 50% ενός διατιθέμενου προϋπολογισμού σε άλλη θέση, εάν αυτό απαιτηθεί.</p> <ul style="list-style-type: none"> <li>i) 10% Κόστος αύξησης</li> <li>ii) 11% Γενικά &amp; Διοικητικά</li> <li>iii) 41% Έρευνα &amp; Ανάπτυξη</li> <li>iv) 17% Νομικά (Παγκόσμια προστασία πνευματικής ιδιοκτησίας)</li> <li>v) 21% Ανάπτυξη λεωφορείων, πωλήσεις και μάρκετινγκ</li> </ul> <p>b) Οι σημερινοί μέτοχοι της AWEARE Technologies Inc. και της Global Innovation Partners Limited περιλαμβάνουν τους Mahesh Reddy και Dr. Daniel Hyman. Οι Mahesh Reddy και Dr. Daniel Hyman είναι επίσης διευθυντές και μέτοχοι μειοψηφίας του Εκδότη.</p> <p>c) Η Equanimity AG εισπράττει προμήθεια συναλλαγών ύψους 3% επί του συνόλου των πληρωμών σε κρυπτονόμισμα και fiat που έχουν συγκεντρωθεί. Ο Marcel Füssinger, ο οποίος είναι ένας από τους διευθυντές του Εκδότη, είναι επίσης διευθυντής και ιδιοκτήτης της Equanimity AG.</p> <p>d) <b>Συνολικά καθαρά έσοδα και εκτιμώμενο κόστος έκδοσης</b> Τα συνολικά καθαρά έσοδα από την προσφορά πάνω από 1.400.000 AWEARE Global Tokens μπορεί να ανέλθουν σε περίπου <b>15.000.000 δολάρια ΗΠΑ</b> που αντιστοιχούν στην υλοποίηση της αύξησης κεφαλαίου. Το αναμενόμενο συνολικό κόστος της προσφοράς ανέρχεται σε περίπου <b>1.500.000 USD</b> και θα χρεωθεί από τα έσοδα.</p> <p>e) <b>Διακανονισμοί αναδοχής</b> Η προσφορά δεν υπόκειται σε συμφωνία αναδοχής. Δεν υπάρχει συμφωνία βάσει της οποίας ένας ανάδοχος υποχρεούται να αναλαμβάνει μη πωληθέντα κουπόνια. Ως εκ τούτου, δεν υπάρχει καμία εγγύηση ότι το σύνολο της προσφοράς θα τοποθετηθεί.</p>

## I. A ΤΑΪΕΚΟΖΤΑΤÓ ÖSSZEFOGLALÓJA

Ez az összefoglaló tartalmazza az összes olyan elemet, amelyet az ilyen típusú értékpapírok és kibocsátók összefoglalójának tartalmaznia kell.

1. SZAKASZ - BEVEZETÉS		
<b>1.1</b>	<b>Az értékpapírok neve és ISIN száma</b>	Az <b>1.400.000</b> új, nyilvánosan kibocsátott részvételi jegy az AWEARE Global AG szavazati jogot nem biztosító, bemutatóra szóló részvételi jegye. E részvételi jegyek neve <b>"AWEARE Global Tokens"</b> . Az ISIN-számuk L11363014385.
<b>1.2</b>	<b>A kibocsátó személyazonossága és elérhetőségei, beleértve a jogalany azonosítóját (LEI) is.</b>	<b>AWEARE Global AG</b> (a "Kibocsátó") c/o Revalier Aktiengesellschaft Pradafant 11, 9490 Vaduz, Hercegség, 9490 Vaduz, Hercegség Tel: +423 237 63 47 E-mail: <a href="mailto:info@awearetech.li">info@awearetech.li</a> A LEI a következő: 391200PTNEZNXGJW1C39
<b>1.3</b>	<b>Illetékes hatóság</b>	<b>Pénzügyi Piaci Hatóság</b> (a "FMA") Landstrasse 109, 9490 Vaduz, Liechtensteini Hercegség, 9490 Vaduz, Liechtensteini Hercegség Tel: +423 236 73 73 Fax: +423 236 73 74 E-mail: <a href="mailto:info@fma-li.li">info@fma-li.li</a>

1.4	<b>A tájékoztató jóváhagyásának időpontja</b>	05/12/2024																		
1.5	<b>Figyelmeztetések</b>																			
1.5.1	<p>a) Az összefoglalót a Tájékoztató bevezetéseként kell olvasni. A befektetőnek az értékpapírokba történő befektetéssel kapcsolatos döntését a Tájékoztató egészének megfontolása alapján kell meghoznia.</p> <p>b) A befektető elveszítheti a befektetett tőke egészét vagy egy részét.</p> <p>c) Amennyiben a tájékoztatóban foglalt információkkal kapcsolatos keresetet nyújtanak be bírósághoz, a nemzeti jog szerint a felperes befektetőnek a bírósági eljárás megindítása előtt esetleg viselnie kell a tájékoztató fordításának költségeit.</p> <p>d) Polgári jogi felelősség csak azokat a személyeket terheli, akik az összefoglalót - beleértve annak fordítását is - benyújtották, de csak akkor, ha az összefoglaló a tájékoztató egyéb részeivel együtt olvasva félrevezető, pontatlan vagy ellentmondásos, vagy ha a tájékoztató egyéb részeivel együtt olvasva nem nyújt olyan kulcsfontosságú információkat, amelyek segítik a befektetőket az értékpapírokba való befektetés megfontolásában.</p>																			
<b>2. SZAKASZ - A KIBOCSÁTÓRA VONATKOZÓ LEGFONTOSABB INFORMÁCIÓK</b>																				
2.1	<b>Ki az értékpapírok kibocsátója?</b>																			
2.1.1	<b>A kibocsátóra vonatkozó információk</b>																			
	<p>a) A kibocsátó jogi és kereskedelmi neve "AWEARE Global AG". A Kibocsátó a Liechtensteini Hercegségben bejegyzett részvénytársaság, amelyre a Liechtensteini Hercegség törvényei vonatkoznak. A Kibocsátó székhelye Vaduzban, a Liechtensteini Hercegségben található, és a Liechtensteini Hercegség Igazságügyi Hivatalában / Kereskedelmi Nyilvántartásában FL-0002.714.015-4 nyilvántartási számon van bejegyezve.</p> <p>b) A kibocsátó célja az autonóm járművek és egyéb alkalmazások számára szenzortechnológiák és mesterséges intelligencia kifejlesztése és pénzzé tétele.</p> <p>c) A Kibocsátó fő részvényesei a következők:</p> <ul style="list-style-type: none"> <li>Global Innovation Partners Limited, Brit Virgin-szigetek, többségi részvényesek: Dr. Daniel Hyman, Mahesh Reddy, Dr. Reginald Tang és Mark Hyman.</li> </ul> <p>d) A Kibocsátó igazgatótanácsát a következők alkotják:</p> <ul style="list-style-type: none"> <li>Dr. Daniel Hyman, állampolgárság: Hyman, állampolgár: Egyesült Államok, levelezési cím: Long Beach, Kalifornia, USA</li> <li>Mahesh Reddy, állampolgárság: Egyesült Államok, Levelezési cím: Irvine, Kalifornia, USA</li> <li>Marcel Füssinger, Állampolgárság: Füssinger: Ausztria, Levelezési cím: Ausztria: 160009, Szingapúr</li> <li>Revalier AG, képviseli: Reinhold Wohlwend, állampolgárság: Wwendweil: Liechtenstein, postacím: 9490, Vaduz, Liechtenstein</li> </ul> <p>e) A könyvvizsgáló: Lucas Tihanyi, a Liechtensteini Könyvvizsgálói és EXPERTsuisse Szövetség tagja, Industriering 14, 9491 Ruggell, Liechtenstein.</p>																			
2.2	<b>Melyek a kibocsátóra vonatkozó legfontosabb pénzügyi információk?</b>																			
2.2.1	<p>A Kibocsátó 2023. november 30-án jött létre a Liechtensteini Hercegség cégjegyzékébe való bejegyzéssel. Az Igazgatótanács 2023. október 25-én kelt nyilatkozata szerint a Kibocsátó nem tartozik rendes könyvvizsgálat alá, és nem áll könyvvizsgálói felülvizsgálat alatt. A 2023. december 31-i éves pénzügyi kimutatásokat és a 2023. július 15-i időközi pénzügyi kimutatásokat azonban a könyvvizsgáló auditálta.</p> <p>Az alábbi főbb pénzügyi információkat a liechtensteini személyekre és társaságokra vonatkozó törvény ("PCL") rendelkezéseivel összhangban készítették el, különösen az alábbi cikkel összhangban. 1024. és azt követő cikkei.</p> <p style="text-align: center;"><b>Eredménykimutatás</b></p> <table border="1" style="width: 100%; border-collapse: collapse;"> <thead> <tr> <th></th> <th style="text-align: center;">31/12/2023</th> <th style="text-align: center;">15/07/2024</th> </tr> </thead> <tbody> <tr> <td><b>Összes bevétel</b></td> <td style="text-align: center;">USD 0</td> <td style="text-align: center;">USD 0</td> </tr> <tr> <td><b>Működési eredmény</b></td> <td style="text-align: center;">USD -2'473.03</td> <td style="text-align: center;">USD -30'150.54</td> </tr> <tr> <td><b>Nettó nyereség/veszteség</b></td> <td style="text-align: center;">USD -2'473.03</td> <td style="text-align: center;">USD -30'150.54</td> </tr> </tbody> </table> <p style="text-align: center;"><b>Mérleg</b></p> <table border="1" style="width: 100%; border-collapse: collapse;"> <thead> <tr> <th></th> <th style="text-align: center;">31/12/2023</th> <th style="text-align: center;">15/07/2024</th> </tr> </thead> <tbody> <tr> <td style="height: 20px;"></td> <td></td> <td></td> </tr> </tbody> </table>			31/12/2023	15/07/2024	<b>Összes bevétel</b>	USD 0	USD 0	<b>Működési eredmény</b>	USD -2'473.03	USD -30'150.54	<b>Nettó nyereség/veszteség</b>	USD -2'473.03	USD -30'150.54		31/12/2023	15/07/2024			
	31/12/2023	15/07/2024																		
<b>Összes bevétel</b>	USD 0	USD 0																		
<b>Működési eredmény</b>	USD -2'473.03	USD -30'150.54																		
<b>Nettó nyereség/veszteség</b>	USD -2'473.03	USD -30'150.54																		
	31/12/2023	15/07/2024																		

Összes eszköz	50'184.35 USD	75'244.30 USD
Saját tőke összesen	USD 47,526.97	19'849.46 USD
Nettó pénzügyi adósság (hosszú lejáratú adósság plusz rövid lejáratú adósság mínusz készpénz)	USD 0	USD 0

#### Cash flow kimutatás

	31/12/2023	15/07/2024
Releváns nettó működési tevékenységből származó pénzáramlás	USD 0	USD 0
Releváns nettó Befektetési tevékenységből származó pénzáramlás	USD 0	USD 0
Releváns nettó Finanszírozási tevékenységből származó pénzáramlás	USD 0	USD 0

A Kibocsátó kilátásai nem romlottak jelentősen a 2024. július 15-i közbenső mérlegfordulónap óta. A Kibocsátó pénzügyi helyzetében vagy kereskedelmi pozíciójában nem történt jelentős változás a 2024/07/15-i időközi mérleg fordulónapja óta.

### 2.3 Melyek a kibocsátóra jellemző legfontosabb kockázatok?

#### Alacsony tőke

A kibocsátó célja az AWEARE technológiájának kereskedelmi hasznosítása. A Kibocsátó saját tőkéje 50.000,00 USD-re korlátozódik, ahol a liechtensteini törvények által előírt minimális tőke 50.000,00 USD. Mivel a Kibocsátót 2023. november 30-án alapították, az ezen összefoglaló 2.2.1. szakaszában említett múltbeli pénzügyi információkon kívül nem állnak rendelkezésre a Kibocsátó pénzügyi helyzetének az elmúlt évekhez viszonyított értékeléséhez szükséges jelentős múltbeli pénzügyi adatok vagy főbb számadatok. A Kibocsátó nem tartozik rendes könyvvizsgálat hatálya alá, és nincs könyvvizsgálói felülvizsgálata. A Kibocsátót nem értékelte hitelminősítő intézet. Az alacsony saját tőke fokozott kockázatot jelent a befektető számára, mivel a szavatolótőke funkciója ennek megfelelően csökken.

#### Fizetéseképtelenségi kockázat

Amennyiben a Kibocsátó vagyona felett fizetéseképtelenségi eljárást indítanak, a Kibocsátó vagyonának elidegenítését átmenetileg vagy véglegesen korlátozzák, vagy a Kibocsátó vagyonának elidegenítését bíróság által kijelölt fizetéseképtelenségi gondnok veszi át. Ez negatív hatással lehet a Kibocsátó pénzügyi helyzetére és üzleti tevékenységére. Ez az eset még akkor is bekövetkezhet, ha a fizetéseképtelenségi kérelmet hibásan nyújtották be. A Kibocsátó fizetéseképtelensége esetén a Résztevők a befektetett tőkékükkel felelnek. A befektetett tőke saját tőkeként kezelendő, és ezért minősített alárendelt.

#### Üzleti finanszírozás

##### 2.3.1

Nincs minimálisan bevonandó tőke. Nincs elhelyezési garancia, hanem annak kockázata, hogy az AWEARE Global Tokeneket nem jegyzik le teljes mértékben (elhelyezési kockázat). Ha a Kibocsátónak nem sikerül a kívánt kibocsátási mennyiséget beszereznie, a Kibocsátó kevesebbet tud befektetni. A Kibocsátó számára fennáll a tőkehiány kockázata. Ezen túlmenően a kibocsátási költségek, amelyek függetlenek a bevont tőke mennyiségétől, fennmaradnak, ami növeli a költséghányadot a teljes bevont befektetési tőkéhez viszonyítva. Fennáll annak a kockázata, hogy ebben az esetben a Kibocsátó nem éri el a tervezett befektetési célokat, és nem lesz képes teljesíteni az AWEARE Global Tokenekből eredő kötelezettségeit.

#### Menedzsment, technológia, harmadik fél szolgáltatóktól való függés, verseny és fejlesztési időkeretek

A kibocsátó egyik fő erőssége a legújabb radartechnológia okos alkalmazása. Az információs és kommunikációs technológiai iparágban azonban a technikai előnyök rövid életűek lehetnek. Ennek megfelelően a kibocsátó sikere részben attól függ, hogy a változó technológiák, a felhasználók és a harmadik fél szolgáltatók igényei és a versenyképesség függvényében képes lesz-e kezelni és bővíteni a kibocsátó szolgáltatásait, illetve növelni az üzleti tevékenységének felhasználói bázisát, és ezáltal bevételt termelni. Ennek elmaradása vagy késedelme hátrányosan befolyásolhatja a Kibocsátó sikerét.

#### Emberi hiba az intelligens szerződésekkel

A Kibocsátó nem vállal felelősséget és nem vállal garanciát a Kibocsátó projektjének vagy a jelen Tájékoztatóval összhangban lévő, tágabb értelemben vett ajánlat elszámolásához programozható vagy felhasználható okos szerződések funkcionalitásával kapcsolatban, és nem vállal garanciát sem. A befektetők ennek következtében

	értékvesztést szenvedhetnek el, vagy általában teljes veszteséggel szembesülhetnek. Ilyen forgatókönyvek esetén azonban jogi mechanizmusok alkalmazhatók a befektető veszteséggel szembeni védelmére.	
<b>3. SZAKASZ - AZ ÉRTÉKPAPÍROKKAL KAPCSOLATOS LEGFONTOSABB INFORMÁCIÓK</b>		
<b>3.1</b>	<b>Melyek az értékpapírok főbb jellemzői?</b>	
<b>3.1.1</b>	<b>Információk az értékpapírokról</b>	
<b>a)</b>	<b>Az értékpapírok típusának és osztályának leírása</b>	A Kibocsátó által nyilvánosan felajánlott <b>1.400.000</b> új részvételi jegy a 2024.07.18-án rendkívüli közgyűlésen elfogadott új részvételi tőke kibocsátásból származó, egyenként <b>0,01 USD</b> névértékű, szavazati jogot nem biztosító, bemutatóra szóló részvételi jegyek (" <b>AWEARE Global Tokens</b> "). Az AWEARE Global Tokenek birtokosait " <b>Részvevőknek</b> " vagy " <b>Token tulajdonosoknak</b> " nevezzük.
<b>b)</b>	<b>Az értékpapír-kibocsátás pénzneme</b>	Egyesült Államok dollárja (" <b>USD</b> " vagy " <b>\$</b> "). Az AWEARE Global Token futamideje korlátlan.
<b>c)</b>	<b>Az értékpapírokhoz kapcsolódó jogok leírása</b>	<p><b>Szavazati jog</b> Az AWEARE Global Tokenek szavazati jogot nem biztosító részvételi igazolások, és nem jogosítják fel a résztvevőt a Kibocsátó közgyűlésén való szavazásra, annak összehívására és az azon való részvételre. Az AWEARE Global Tokenek továbbá nem biztosítanak tájékoztatáshoz, betekintéshez és kérelem benyújtásához való jogot. A közgyűléshez azonban írásban tájékoztatás vagy betekintés iránti kérelem, illetve hatósági ellenőrzés kezdeményezése iránti kérelem nyújtható be.</p> <p><b>A közgyűlés összehívásáról és határozatairól szóló értesítés</b> A közgyűlés összehívásáról, a napirendi pontokról és az indítványokról a résztvevőket értesíteni kell. A közgyűlés minden határozatát a résztvevők számára haladéktalanul hozzáférhetővé kell tenni a Kibocsátó székhelyén. Erről a résztvevőket az értesítésben tájékoztatni kell.</p> <p><b>Osztalékra való jogosultság és a felszámolási bevételből való részesedés</b> Az AWEARE Global Tokenek az érvényes megszerzés napjától teljes osztalékjogosultsággal rendelkeznek, és a tulajdonosukat a részvételi tőkében való részesedésük arányában a felszámolási bevételből való részesedésre jogosítják. A Kibocsátó jelenleg nem tervez osztalékot fizetni a közeljövőben. Bár az alapszabály szerint az osztalékra való igény fennáll, a jövőbeni osztalékfizetésre vonatkozóan nem készülnek előrejelzések. A Kibocsátó a nyereséget a vállalat további növekedésére és fejlesztésére kívánja visszaforgatni.</p> <p><b>Forma és értékpapírosítás</b> Az AWEARE Global Tokeneket tokenek formájában bocsátják ki. A tokenek olyan értékjogok, amelyeket egy decentralizált adatbázisban (Blockchain) bocsátanak ki, és ott továbbítanak. Az erre a célra használt Blockchain az Ethereum Blockchain.</p> <p><b>A jegyzési és részvételi jogok kizárása</b> Az 50 000 USD céltőke eléréséig a PCL 304d, 304f és 304g cikke szerinti kedvezményes jogok, különösen a résztvevők jegyzési és részvételi jogai, kizártak.</p> <p><b>Az értékpapírok átruházhatósága</b> Az AWEARE Global Tokenek átruházásához (például a szűkebb értelemben vett átruházás, elzálogosítás, öröklés) a Kibocsátó Igazgatótanácsának jóváhagyása szükséges. Az átruházhatóság ezért bizonyos mértékig korlátozott. Az AWEARE Global Tokenek átruházása semmiképpen sem megengedett, ha azok ezután olyan országban lévő személy birtokába kerülnének, ahol az AWEARE Global Tokeneket nem lehet felajánlani. A fenti értelemben vett átruházásnak minősül az is, ha a Token-tulajdonos a lakóhelyét olyan országba helyezi át, ahol az AWEARE Global Tokeneket nem lehet felajánlani.</p>
<b>d)</b>	<b>Az értékpapírok relatív elsőbbsége a kibocsátó tőkeszerkezetében fizetésképtelenség esetén</b>	A Kibocsátó fizetésképtelensége esetén a résztvevők a befektetett tőkékkel felelnek. A befektetett tőke saját tőkeként kezelendő, és ezért minősített alárendelt.
<b>e)</b>	<b>Az osztalékpolitika leírása</b>	Eddig nem fizettek osztalékot. A Kibocsátó nem készít nyereség-előrejelzéseket vagy -becsléseket, ezért az osztalékpolitika leírására nem kerül sor. Az esetleges osztalékfizetés USD-ben történik. A Kibocsátó fenntartja a jogot, hogy más pénznemben vagy kriptovalutában is fizessen osztalékot. Az osztalékfizetésre vonatkozó bármely határozat az alkalmazandó jogszabályokkal összhangban kerül meghozatalra, és többek között a Kibocsátó működési eredményétől, pénzügyi

		helyzetétől, szerződéses korlátozásoktól és tőkeszükségletétől függ. A nettó nyereség 5%-át minden esetben a kötelező tartalékokba helyezik, amíg az el nem éri a befizetett alaptőke 10%-át.
<b>3.2</b>	<b>Hol fognak kereskedni az értékpapírokkal?</b>	
<b>3.2.1</b>	Az AWEARE Global Tokeneket nem engedik be szabályozott piacra kereskedni. A Kibocsátó fenntartja a jogot, hogy kérelmezze a szabályozott piacra történő bevezetést.	
<b>3.4</b>	<b>Melyek az értékpapírokra jellemző legfontosabb kockázatok?</b>	
<b>3.4.1</b>	<p><b>Befektetők pénztárcája és a privát kulcs kockázata</b> A befektető egyedül viseli a tárca kiválasztásának vagy a privát kulcs helyének kockázatát. Ha nem kompatibilis tárcát használnak, vagy ha a privát kulcs elveszik, az AWEARE Global Tokenekhez való hozzáférés általában lehetetlen. A következményeket, például a befektetés teljes elvesztését, kizárólag a befektetőnek kell viselnie.</p> <p><b>Eladhatósági, likviditási és realizálási kockázat</b> Nem biztos, hogy az AWEARE Global Tokenek számára likvid piac fog kialakulni. Ennek következtében az AWEARE Global Tokeneket nem lehet másodlagos piacon értékesíteni, ami likviditási kockázatot jelent a befektető számára.</p> <p><b>Volatilitási kockázat</b> A részvényárfolyam volatilitásával kapcsolatban kockázatok merülnek fel. Ha az AWEARE Global Tokeneket értékesíteni kellene, és azok az árfolyam hirtelen lefelé irányuló ingadozásába kerülnének, a Token-tulajdonos az eladás következtében veszteségeket szenvedhetne el, amelyek közül néhány jelentős lehet.</p> <p><b>A zsetonok elvesztése</b> A Tokenek elveszhetnek vagy hozzáférhetetlenné válhatnak, különösen, ha a Token-tulajdonos elveszíti az AWEARE Global Tokenek feletti rendelkezési jogosultságához szükséges privát kulcsot, vagy ha az AWEARE Global Tokeneket tároló e-pénztárca meghibásodik. Ez a Tokenek elvesztéséhez vezethet. A Token-tulajdonosok kizárólagos felelőssége az e-pénztárcahoz való hozzáférést lehetővé tevő magánkulcs biztonságos tárolása és védelme. A Tokenek hozzáférhetetlenné válhatnak a Tokentulajdonos halála esetén is, ha nem intézkedett ilyen esetekre. Sem a Kibocsátó, sem más szerv vagy intézmény nem lesz képes arra, hogy a Tokentulajdonos utódai számára helyreállítsa a Tokentulajdonos pénztárcájához való hozzáférést. A privát kulcsok elvesztése továbbá csökkentheti az STO és az AWEARE Global Token különböző funkcióinak elérhetőségét. Különösen lehetetlenné válhat az AWEARE Global Tokenek kibocsátása az előfizetők számára, illetve az átruházhatóvá tételük, amely esetben azok határozatlan ideig szünetelnek. Továbbá lehetetlen lehet osztalékfizetést teljesíteni. Végül fennáll annak a kockázata, hogy egy támadó AWEARE Global Tokeneket verethet nem hozzájáruló címekre, megváltoztathatja a visszaigazolási státuszt, ellenőrizetlen összegekkel járulhat hozzá az STO-hoz, vagy lehetővé teheti a támadó számára, hogy a be nem igényelt osztalékfizetéseket visszavonja.</p> <p><b>A Token-tulajdonosok korlátozott jogai</b> Az AWEARE Global Tokenek nem szavazati jogot biztosító részvételi igazolások, és nem jogosítják fel a Token-tulajdonosokat a Kibocsátó közgyűlésén való szavazásra, annak összehívására és a közgyűlésen való részvételre. Az AWEARE Globális Tokenek továbbá nem biztosítanak tájékoztatáshoz, betekintéshez és kérelem benyújtásához való jogot. A Kibocsátó közgyűlése ezért olyan határozatokat hozhat, amelyek hátrányosan érinthetik a Tokentulajdonosok jogait. A Tokentulajdonosoknak nincs lehetőségük az AWEARE Globális Tokenek kibocsátásából származó bevételek felhasználásának ellenőrzésére. Az AWEARE Global Tokenek átruházásához (például szűk értelemben vett átruházás, zálogba adás, öröklés) a Kibocsátó Igazgatóságának jóváhagyása szükséges. Az AWEARE Global Tokenek átruházása semmiképpen sem megengedett, ha azok ezután olyan országban lévő személy birtokába kerülnének, ahol az AWEARE Global Tokeneket nem lehet felajánlani. A fenti értelemben vett átruházásnak minősül az is, ha a Tokentulajdonos a lakóhelyét olyan országba helyezi át, ahol az AWEARE Global Tokeneket nem lehet felajánlani. A Tokentulajdonosok törvényes jegyzési joga a jelen ajánlat szerinti tőkeemelés esetén kizárt.</p> <p><b>A Tokentulajdonosok követeléseit alárendelték</b> A Tokentulajdonosoknak a Kibocsátótól való osztalékfizetésre és osztalékfizetésre vonatkozó jogai a Kibocsátó valamennyi, nem alárendelt kötelezettségeinek jogosultjainak követeléseivel képest alárendelték. A Kibocsátó felszámolása esetén a Tokentulajdonosok csak akkor és csak azt követően részesülnek kifizetésben, ha és miután a Kibocsátó valamennyi elsőbbségi kötelezettsége teljesítésre került.</p>	
<b>4. SZAKASZ - AZ ÉRTÉKPAPÍROK NYILVÁNOS FELAJÁNLÁSÁVAL KAPCSOLATOS LEGFONTOSABB INFORMÁCIÓK</b>		
<b>4.1</b>	<b>Milyen feltételek és menetrend mellett fektethetők be ebbe az értékpapírba?</b>	
<p><b>Országok, ahol az értékpapírokat kínálják</b> Az ajánlat nyilvános ajánlattételből áll Ausztriában, Belgiumban, Bulgáriában, Cipruson, Csehországban, Dániában, Észtországban, Finnországban, Franciaországban, Görögországban, Horvátországban, Németországban, Magyarországon, Izlandon, Írországon, Olaszországban, Lettországon, Liechtensteinben, Litvániában, Luxemburgban, Máltán, Hollandiában, Norvégiában, Lengyelországban, Portugáliában, Romániában, Szlovákiában, Szlovéniában,</p>		



Spanyolországban, Svédországban és Svájcban, valamint egyes, ezeken kívüli joghatóságokban történő zártkörű kibocsátásokból.

#### Országok, amelyekben az értékpapírokat nem kínálják

A Kibocsátó AWEARE Global Tokenjei nincsenek és nem is lesznek bejegyezve az Egyesült Államok módosított 1933. évi értékpapírtörvényének rendelkezései szerint, illetve az Amerikai Egyesült Államok bármely államának, illetve Ausztrália, Japán vagy Kanada értékpapír-felügyeleti hatóságai által. Ennek megfelelően nem kínálhatók, értékesíthetők vagy szállíthatók sem közvetlenül, sem közvetve a nyilvánosságnak, kivéve a regisztrációs követelmények alóli mentesség alapján. Különösen, ez a tájékoztató nem minősül vagy nem minősül az Amerikai Egyesült Államokban, Ausztráliában, Japánban és Kanadában az AWEARE Global Tokenek eladására vagy megvásárlására irányuló ajánlatnak, és nem terjeszthető ott. Ezen túlmenően a jelen Tájékoztató nem minősül vagy nem minősül az AWEARE Global Tokenek Oroszországban, Iránban, Észak-Koreában, Fehéroroszországban, Szíriában vagy ezek bármely területén történő eladására vonatkozó ajánlatnak vagy vételi ajánlatra való felhívásnak. És ott nem terjeszthető.

#### Licitálás

Az AWEARE Global Tokenek jegyzési folyamata online történik a <https://kyc.awearetech.li/> weboldalon (a "Dashboard").

#### Ajánlati időszak

Az az időszak, amely alatt a befektetők vételi ajánlatot tehetnek az AWEARE Global Tokenekre, a Tájékoztató jóváhagyásának napján kezdődik és egy évvel később ér véget ("**Ajánlattételi időszak**"). Az Ajánlattételi időszak utolsó napján az ajánlatokat liechtensteini idő szerint déli 12:00 óráig lehet benyújtani.

#### Ajánlati ár

Egy AWEARE Token ajánlati ára **12,00 USD** ("**Ajánlati ár**").

A korai befektetés ösztönzése érdekében a következő kedvezmények vehetők igénybe:

A 10.000 USDC és 49.999,99 USDC közötti befektetések esetén a befektetők 10%-os kedvezményt kapnak, így egy AWEARE Token ára 10,80 USD lesz.

50.000 USDC vagy annál nagyobb összegű befektetés esetén a befektetők 15%-os kedvezményt kapnak, így egy AWEARE Token ára 10,20 USD lesz.

#### A kedvezmények elérhetősége

A fenti kedvezmények az alábbiak valamelyikének bekövetkezéséig vehetők igénybe, attól függően, hogy melyik következik be előbb:

- **5 000 000 USDC teljes befektetési volument elérve,** vagy
- **az ajánlat kezdetétől számított három hónap elteltével.**

#### Szállítás és elszámolás

Minden befektetőnek ki kell töltenie az online előfizetési folyamatot a műszerfalon. Az AWEARE Global Tokeneket a Kibocsátó adatbázisában lévő, a Dashboardon keresztül megtekinthető rekordként, az ajánlati ár megfizetése ellenében, off-chain módon osztják ki. Az AWEARE Global Tokeneket on-chain az intelligens szerződésben osztják ki legkésőbb az ajánlattételi időszak végét követő két hónapon belül. Amint az AWEARE Global Tokenek teljes felajánlása (a részvételi céltörke elérése után) véget ér, és a Kibocsátó úgy döntött, hogy véglegesíti az intelligens szerződést, az AWEARE Global Tokeneket a befektető kriptotárcájába szállítják.

#### Hígitás

Mivel az ajánlat keretében végrehajtott tőkeemelés esetén valamennyi résztvevő törvényes jegyzési joga kizárt, az ajánlat résztvevői nem hígnak fel.

#### Teljes nettó bevétel és becsült kibocsátási költségek

Az 1.400.000 AWEARE Global Token feletti ajánlat teljes nettó bevétel körülbelül **15.000.000.000 USD-t** tehet ki, ami megfelel az alapbevonás végrehajtásának. Az ajánlat várható teljes költségei körülbelül **1.500.000 USD-t** tesznek ki, és a bevételekből kerülnek felszámításra.

<b>4.2</b>	<b>Miért készül ez a tájékoztató?</b>
<b>4.2.1</b>	<p>a) Az értékpapírok kibocsátásából származó becsült nettó bevételt elsősorban kutatásra és fejlesztésre, valamint a szellemi tulajdon védelmére fogják felhasználni. Szükség esetén szükség lehet arra, hogy egy elkülönített költségvetés legfeljebb 50%-át más pozícióra csoportosítsák át.</p> <ul style="list-style-type: none"><li>i) 10% Az emelés költsége</li><li>ii) 11% Általános és adminisztratív költségek</li><li>iii) 41% Kutatás és fejlesztés</li><li>iv) 17% Jogi (globális IP-védelem)</li><li>v) 21% Buszfejlesztés, értékesítés és marketing</li></ul> <p>b) Az AWEARE Technologies Inc. és a Global Innovation Partners Limited jelenlegi részvényesei közé tartozik Mahesh Reddy és Dr. Daniel Hyman. Mahesh Reddy és Dr. Daniel Hyman egyben a Kibocsátó igazgatói és</p>

	<p>kisebbségi részvényesei is.</p> <p>c) Az Equanimity AG a teljes felhalmozott kriptopénz és fiat fizetések 3%-ának megfelelő tranzakciós díjat kap. Marcel Füssinger, aki a kibocsátó egyik igazgatója, egyben az Equanimity AG igazgatója és tulajdonosa is.</p> <p>d) <b>Teljes nettó bevétel és becsült kibocsátási költségek</b> Az 1.400.000 AWEARE Global Token feletti ajánlat teljes nettó bevétele körülbelül <b>15.000.000.000 USD-t</b> tehet ki, ami megfelel az alapbevonás végrehajtásának. Az ajánlat várható teljes költségei körülbelül <b>1.500.000 USD-t</b> tesznek ki, és a bevételekből kerülnek felszámításra.</p> <p>e) <b>Biztosítási megállapodások</b> A kibocsátás nem kötött jegyzési megállapodás tárgyát képezi. Nincs olyan megállapodás, amely alapján az ajánlattevő köteles lenne az eladatlan zsetonok jegyzésére. Ezért nincs garancia arra, hogy a teljes kibocsátás elhelyezésre kerül.</p>
--	--

## XIV. PROSPEKTA KOPSAVILKUMS

Šajā kopsavilkumā ietverti visi elementi, kas jāiekļauj šāda veida vērtspapīru un emitenta kopsavilkumā.

1. IEDAĻA - IEVADS		
1.1	<b>Vērtspapīru nosaukums un ISIN kods</b>	Publiski pieejamie <b>1 400 000</b> jaunie līdzdalības sertifikāti ir AWEARE Global AG uzrādītāja līdzdalības sertifikāti bez balsstiesībām. Šo līdzdalības sertifikātu nosaukums ir " <b>AWEARE Global Tokens</b> ". ISIN ir LI1363014385.
1.2	<b>Emitenta identitāte un kontaktinformācija, tostarp tā juridiskās personas identifikators (LEI).</b>	<b>AWEARE Global AG ("Emitents")</b> c/o Revalier Aktiengesellschaft Pradafant 11, 9490 Vaduz, Principality of Tālrunis: +423 237 63 47 E-pasts: info@awearetech.li LEI ir: 391200PTNEZNXGJW1C39
1.3	<b>Kompetentā iestāde</b>	<b>Finanšu tirgus iestāde ("FMA")</b> Landstrasse 109, 9490 Vaduz, Lihtenšteinas Firstiste Tālrunis: +423 236 73 73 73 Fakss: +423 236 73 74 E-pasts: <a href="mailto:info@fma.li">info@fma.li</a>
1.4	<b>Prospekta apstiprināšanas datums</b>	05/12/2024
1.5	<b>Brīdinājumi</b>	
1.5.1	<p>a) Šis kopsavilkums ir jālasa kā prospekta ievads. Jebkurš lēmums ieguldīt vērtspapīros jāpieņem, pamatojoties uz Prospekta izvērtējumu kopumā.</p> <p>b) Ieguldītājs var zaudēt visu ieguldīto kapitālu vai tā daļu.</p> <p>c) Ja tiesā tiek celta prasība saistībā ar prospektā iekļauto informāciju, saskaņā ar valsts tiesību aktiem prasītājam ieguldītājam var nākties segt prospekta tulkošanas izmaksas pirms tiesvedības uzsākšanas.</p> <p>d) Civiltiesiskā atbildība attiecas tikai uz tām personām, kuras ir iesniegušas kopsavilkumu, tostarp tā tulkojumu, bet tikai tad, ja kopsavilkums ir maldinošs, neprecīzs vai nekonsekvents, lasot to kopā ar pārējām prospekta daļām, vai arī, lasot to kopā ar pārējām prospekta daļām, tajā nav sniegta galvenā informācija, lai palīdzētu ieguldītājiem apsvērt, vai ieguldīt vērtspapīros.</p>	
IEDAĻA - GALVENĀ INFORMĀCIJA PAR EMITENTU		
2.1	<b>Kas ir vērtspapīru emitents?</b>	
2.1.1	<b>Informācija par emitentu</b>	
	a) Emitenta juridiskais un komerciālais nosaukums ir "AWEARE Global AG". Emitents ir Lihtenšteinas Firstistē reģistrēta akciju sabiedrība, uz kuru attiecas Lihtenšteinas Firstistes tiesību akti. Emitenta juridiskā adrese ir	

	<p>Vaducā, Lihtenšteinas Firstistē, un tas ir reģistrēts Lihtenšteinas Firstistes Tieslietu birojā / Komercreģistrā ar reģistrācijas numuru FL-0002.714.015-4.</p> <p>b) Emitenta mērķis ir izstrādāt un peļnīt no sensoru tehnoloģijām un mākslīgā intelekta autonomiem transportlīdzekļiem un citiem lietojumiem.</p> <p>c) Emitenta galvenie akcionāri ir:</p> <ul style="list-style-type: none"> <li>• Global Innovation Partners Limited, Britu Virdžīnu salas, ar galvenajiem akcionāriem Dr. Daniel Hyman, Mahesh Reddy, Dr. Reginald Tang un Mark Hyman.</li> </ul> <p>d) Emitenta valde ir:</p> <ul style="list-style-type: none"> <li>• Dr. Daniel Hyman, pilsonība: Amerikas Savienotās Valstis, Pasta adrese: Hyman Hyman, tālrunis: Longbiča, Kalifornija, ASV</li> <li>• Mahesh Reddy, valstspiederība: Amerikas Savienotās Valstis, Pasta adrese: Adrese: Irvine, Kalifornija, ASV</li> <li>• Marcel Füssinger, valstspiederība: Austrijas pilsonis, pasta adrese: Adrese: 160009, Singapūra</li> <li>• Revalier AG, ko pārstāv Reinhold Wohlwend, pilsonība: Lihtenšteina, pasta adrese: 9490, Vaduz, Lihtenšteina</li> </ul> <p>e) Revidents ir: Lucas Tihanyi, Lihtenšteinas Revidentu asociācijas loceklis un EXPERTsuisse, Industriering 14, 9491 Ruggell, Llechtenstein.</p>																																				
2.2	<p><b>Kāda ir galvenā finanšu informācija par emitentu?</b></p>																																				
2.2.1	<p>Emitents tika dibināts 2023. gada 30. novembrī ar ierakstu Lihtenšteinas Firstistes komercēģistrā. Saskaņā ar 2023. gada 25. oktobra Direktoru padomes deklarāciju Emitentam netiek veikta parastā revīzija un netiek veikta revīzijas pārbaude. Tomēr gada finanšu pārskatu 2023. gada 31. decembrī un starpposma finanšu pārskatu 2023. gada 15. jūlijā revīziju veica revidents.</p> <p>Turpmāk sniegtā galvenā finanšu informācija ir sagatavota saskaņā ar Lihtenšteinas Personu un uzņēmumu likuma ("PCL") noteikumiem, jo īpaši saskaņā ar tā 2. pantu. 1024 un turpmākajiem pantiem.</p> <p style="text-align: center;"><b>Peļņas un zaudējumu aprēķins</b></p> <table border="1" style="width: 100%; border-collapse: collapse;"> <thead> <tr> <th></th> <th style="text-align: center;">31/12/2023</th> <th style="text-align: center;">15/07/2024</th> </tr> </thead> <tbody> <tr> <td><b>Kopējie ieņēmumi</b></td> <td style="text-align: center;">USD 0</td> <td style="text-align: center;">USD 0</td> </tr> <tr> <td><b>Darbības peļņa/zaudējumi</b></td> <td style="text-align: center;">USD -2'473,03</td> <td style="text-align: center;">USD -30'150.54</td> </tr> <tr> <td><b>Neto peļņa/zaudējumi</b></td> <td style="text-align: center;">USD -2'473,03</td> <td style="text-align: center;">USD -30'150.54</td> </tr> </tbody> </table> <p style="text-align: center;"><b>Bilance</b></p> <table border="1" style="width: 100%; border-collapse: collapse;"> <thead> <tr> <th></th> <th style="text-align: center;">31/12/2023</th> <th style="text-align: center;">15/07/2024</th> </tr> </thead> <tbody> <tr> <td><b>Aktīvu kopsumma</b></td> <td style="text-align: center;">50'184,35 USD</td> <td style="text-align: center;">75'244,30 USD</td> </tr> <tr> <td><b>Kopējais pašu kapitāls</b></td> <td style="text-align: center;">47 526,97 USD</td> <td style="text-align: center;">19'849,46 USD</td> </tr> <tr> <td><b>Neto finanšu parāds (ilgtermiņa parāds plus īstermiņa parāds mīnus nauda)</b></td> <td style="text-align: center;">USD 0</td> <td style="text-align: center;">USD 0</td> </tr> </tbody> </table> <p style="text-align: center;"><b>Naudas plūsmas pārskats</b></p> <table border="1" style="width: 100%; border-collapse: collapse;"> <thead> <tr> <th></th> <th style="text-align: center;">31/12/2023</th> <th style="text-align: center;">15/07/2024</th> </tr> </thead> <tbody> <tr> <td><b>Attiecīgās neto naudas plūsmas no pamatdarbības</b></td> <td style="text-align: center;">USD 0</td> <td style="text-align: center;">USD 0</td> </tr> <tr> <td><b>Attiecīgās neto naudas plūsmas no ieguldījumu darbības</b></td> <td style="text-align: center;">USD 0</td> <td style="text-align: center;">USD 0</td> </tr> <tr> <td><b>Attiecīgās neto Naudas plūsmas no finansēšanas darbības</b></td> <td style="text-align: center;">USD 0</td> <td style="text-align: center;">USD 0</td> </tr> </tbody> </table>		31/12/2023	15/07/2024	<b>Kopējie ieņēmumi</b>	USD 0	USD 0	<b>Darbības peļņa/zaudējumi</b>	USD -2'473,03	USD -30'150.54	<b>Neto peļņa/zaudējumi</b>	USD -2'473,03	USD -30'150.54		31/12/2023	15/07/2024	<b>Aktīvu kopsumma</b>	50'184,35 USD	75'244,30 USD	<b>Kopējais pašu kapitāls</b>	47 526,97 USD	19'849,46 USD	<b>Neto finanšu parāds (ilgtermiņa parāds plus īstermiņa parāds mīnus nauda)</b>	USD 0	USD 0		31/12/2023	15/07/2024	<b>Attiecīgās neto naudas plūsmas no pamatdarbības</b>	USD 0	USD 0	<b>Attiecīgās neto naudas plūsmas no ieguldījumu darbības</b>	USD 0	USD 0	<b>Attiecīgās neto Naudas plūsmas no finansēšanas darbības</b>	USD 0	USD 0
	31/12/2023	15/07/2024																																			
<b>Kopējie ieņēmumi</b>	USD 0	USD 0																																			
<b>Darbības peļņa/zaudējumi</b>	USD -2'473,03	USD -30'150.54																																			
<b>Neto peļņa/zaudējumi</b>	USD -2'473,03	USD -30'150.54																																			
	31/12/2023	15/07/2024																																			
<b>Aktīvu kopsumma</b>	50'184,35 USD	75'244,30 USD																																			
<b>Kopējais pašu kapitāls</b>	47 526,97 USD	19'849,46 USD																																			
<b>Neto finanšu parāds (ilgtermiņa parāds plus īstermiņa parāds mīnus nauda)</b>	USD 0	USD 0																																			
	31/12/2023	15/07/2024																																			
<b>Attiecīgās neto naudas plūsmas no pamatdarbības</b>	USD 0	USD 0																																			
<b>Attiecīgās neto naudas plūsmas no ieguldījumu darbības</b>	USD 0	USD 0																																			
<b>Attiecīgās neto Naudas plūsmas no finansēšanas darbības</b>	USD 0	USD 0																																			

	<p>Emitenta perspektīvas kopš starpposma bilances datuma 2024. gada 15. jūlijā nav būtiski pasliktinājušās. Kopš starpperioda bilances uz 15.07.2024. gada 15.07.2024. pārskata datuma nav notikušas būtiskas izmaiņas Emitenta finanšu stāvoklī vai tirdzniecības stāvoklī.</p>	
<b>2.3</b>	<b>Kādi ir galvenie emitentam raksturīgie riski?</b>	
<b>2.3.1</b>	<p><b>Zems kapitāls</b>  Emitenta mērķis ir AWEARE tehnoloģijas komercializācija. Emitenta pašu kapitāls ir ierobežots līdz USD 50 000,00, kur Lihtenšteinas tiesību aktos noteiktais minimālais kapitāls ir USD 50 000,00. Tā kā Emitents tika reģistrēts 2023. gada 30. novembrī, nav pieejami nekādi nozīmīgi vēsturiski finanšu dati vai galvenie skaitļi, izņemot šī kopsavilkuma 2.2.1. sadaļā minēto vēsturisko finanšu informāciju, lai novērtētu Emitenta finansiālo stāvokli attiecībā uz iepriekšējiem gadiem. Emitentam netiek veikta parastā revīzija, un tam netiek veikta revīzijas pārbaude. Emitentu nav novērtējusi reitinga aģentūra. Zems pašu kapitāls rada paaugstinātu risku ieguldītājam, jo attiecīgi samazinās Emitenta kā atbildīgā kapitāla funkcija.</p> <p><b>Maksātnespējas risks</b>  Maksātnespējas procesa uzsākšanas gadījumā attiecībā uz Emitenta aktīviem Emitentam uz laiku vai pastāvīgi tiks ierobežota tā aktīvu atsavināšana vai arī Emitenta aktīvu atsavināšanu pārņems tiesas iecelts maksātnespējas administrators. Tas var negatīvi ietekmēt Emitenta finansiālo stāvokli un saimniecisko darbību. Šāds gadījums var notikt pat tad, ja maksātnespējas pieteikumi ir iesniegti nepareizi. Emitenta maksātnespējas gadījumā Dalībnieki ir atbildīgi ar savu ieguldīto kapitālu. Ieguldītais kapitāls ir uzskatāms par pašu kapitālu, un tādēļ tas ir kvalificēti pakārtots.</p> <p><b>Uzņēmējdarbības finansēšana</b>  Nav noteikts minimālais piesaistāmais kapitāls. Nav izvietojuma garantijas, bet pastāv risks, ka AWEARE globālie žetoni netiks pilnībā parakstīti (izvietojuma risks). Ja Emitentam neizdosies piesaistīt vēlamu emisijas apjomu, Emitents varēs ieguldīt mazāk. Emitentam pastāv kapitāla iztrūkuma risks. Turklāt saglabāsies emisijas izmaksas, kas nav atkarīgas no piesaistītā kapitāla apjoma, kas palielinās izdevumu attiecību pret kopējo piesaistīto ieguldījumu kapitālu. Pastāv risks, ka šādā gadījumā Emitents nespēs īstenot plānotos ieguldījumu mērķus un nespēs izpildīt savas saistības saskaņā ar AWEARE Global Token.</p> <p><b>Vadība, tehnoloģijas, atkarība no trešo pušu pakalpojumu sniedzējiem, konkurence un attīstības termiņi.</b>  Viena no galvenajām Emitenta priekšrocībām ir tā pārdomātā jaunāko radaru tehnoloģiju izmantošana. Tomēr tehniskās priekšrocības informācijas un komunikāciju tehnoloģiju nozarē var būt īslaicīgas. Attiecīgi Emitenta panākumi daļēji būs atkarīgi no tā spējas pārvaldīt un paplašināt Emitenta pakalpojumus un palielināt tā uzņēmējdarbības lietotāju bāzi, tādējādi gūstot iegūjumus, reaģējot uz mainīgajām tehnoloģijām, lietotāju un trešo personu pakalpojumu sniedzēju prasībām un konkurences spiedienu. Nespēja vai kavēšanās šajā jomā var negatīvi ietekmēt Emitenta panākumus.</p> <p><b>Cilvēka kļūda ar viedajiem līgumiem</b>  Emitents neuzņemas nekādu atbildību un nesniedz nekādus apliecinājumus vai garantijas attiecībā uz Emitenta projekta vai jebkuru viedo līgumu funkcionalitāti, kas var tikt programmēti vai izmantoti piedāvājuma norēķiniem saskaņā ar šo Prospektu visplašākajā nozīmē. Ieguldītāji tā rezultātā var ciest zaudējumus vai kopumā saskarties ar pilnīgiem zaudējumiem. Tomēr šādos scenārijos var tikt piemēroti tiesiskie mehānismi, lai aizsargātu ieguldītāju no zaudējumiem.</p>	
<b>IEDAĻA - GALVENĀ INFORMĀCIJA PAR VĒRTSPAPĪRIEM</b>		
<b>3.1</b>	<b>Kādas ir vērtspapīru galvenās iezīmes?</b>	
<b>3.1.1</b>	<b>Informācija par vērtspapīriem</b>	
<b>a)</b>	<b>Vērtspapīru veida un klases apraksts</b>	Emitenta publiski piedāvātie <b>1 400 000</b> jaunie līdzdalības sertifikāti ir uzrādītāja līdzdalības sertifikāti bez balsstiesībām, katrs ar nominālvērtību <b>0,01 USD</b> no līdzdalības kapitāla (" <b>AWEARE Global Tokens</b> "), kas iegūti no jaunas līdzdalības kapitāla emisijas, par kuru lēmums pieņemts ārkārtas akcionāru sapulcē 2024. gada 18. jūlijā. AWEARE globālo žetonu turētāji tiek saukti par " <b>dalībniekiem</b> " vai " <b>žetonu turētājiem</b> ".
<b>b)</b>	<b>Vērtspapīru emisijas valūta</b>	Amerikas Savienoto Valstu dolārs (" <b>USD</b> " vai " <b>\$</b> "). AWEARE Global Token termiņš ir neierobežots.
<b>c)</b>	<b>Ar vērtspapīriem saistīto tiesību apraksts</b>	<p><b>Tiesības balsot</b>  AWEARE globālie žetoni ir līdzdalības sertifikāti bez balsstiesībām, un tie nedod Dalībniekam tiesības balsot, sasaukt un piedalīties Emitenta kopsapulcē. Turklāt AWEARE globālie žetoni nedod tiesības uz informāciju, pārbaudes tiesībām un tiesībām iesniegt pieteikumu. Tomēr Kopsapulcei var iesniegt rakstisku pieprasījumu sniegt informāciju vai veikt pārbaudi, vai uzsākt oficiālu revīziju.</p> <p><b>Paziņojums par pilnsapulces sasaukšanu un lēmumiem</b>  Dalībniekiem jāpaziņo par pilnsapulces sasaukšanu, kā arī darba kārtības jautājumi un priekšlikumi. Katram kopsapulces lēmumam nekavējoties jābūt</p>

		<p>pieejamam Dalībniekiem, lai tie varētu iepazīties ar to Emitenta juridiskajā adresē. Dalībnieki par to tiek informēti paziņojumā.</p> <p><b>Tiesības uz dividendēm un likvidācijas ieņēmumu daļa</b>  AWEARE globālajiem žetoniem ir pilnas tiesības uz dividendēm no derīgas iegādes datuma, un to turētājiem ir tiesības uz daļu no likvidācijas ieņēmumiem proporcionāli viņu līdzdalībai līdzdalības kapitālā. Emitents pašlaik neplāno tuvākajā nākotnē izmaksāt dividendes. Lai gan saskaņā ar statūtiem pastāv prasība uz dividendēm, netiek veiktas nekādas prognozes par dividenžu izmaksu nākotnē. Emitents plāno reinvestēt peļņu turpmākai uzņēmuma izaugsmei un attīstībai.</p> <p><b>Forma un vērtspapīrošana</b>  AWEARE Global Tokens tiks emitēti kā žetoni. Žetoni ir vērtības tiesības, kas tiek emitētas decentralizētā datu bāzē (Blockchain) un tur arī nodotas. Šim nolūkam izmantotā blokķēde ir Ethereum blokķēde.</p> <p><b>Parakstīšanās tiesību un līdzdalības tiesību izslēgšana</b>  Līdz brīdim, kad tiek sasniegts mērķa līdzdalības kapitāls 50 000 USD apmērā, tiek izslēgtas priekšrocību tiesības saskaņā ar PCL 304.d, 304.f un 304.g pantu, jo īpaši dalībnieku parakstīšanās tiesības un līdzdalības tiesības.</p> <p><b>Vērtspapīru pārvedamība</b>  AWEARE globālo žetonu nodošanai (piemēram, nodošanai šaurākā nozīmē, iekļūšanai, mantošanai) ir nepieciešama Emitenta valdes piekrišana. Tādēļ pārvedamība ir zināmā mērā ierobežota. Jebkurā gadījumā AWEARE Global Tokens nodošana nav atļauta, ja tie nonāktu personas turējumā valstī, kurā AWEARE Global Tokens nedrīkst piedāvāt. Par nodošanu iepriekš minētajā nozīmē tiek uzskatīts arī tad, ja Token turētājs maina savu dzīvesvietu uz valsti, kurā AWEARE globālos žetonus nedrīkst piedāvāt.</p>
d)	<b>Vērtspapīru relatīvais prioritārais rangs emitenta kapitāla struktūrā maksātspējas gadījumā</b>	Emitenta maksātspējas gadījumā Dalībnieki ir atbildīgi ar savu ieguldīto kapitālu. Ieguldītais kapitāls ir uzskatāms par pašu kapitālu, un tādēļ tas ir pakārtots ar nosacījumiem.
e)	<b>Dividenžu politikas apraksts</b>	Līdz šim dividendes nav izmaksātas. Emitents nesagatavo peļņas prognozes vai aplēses, tāpēc dividenžu politika netiek aprakstīta. Dividendes, ja tādas tiks izmaksātas, tiks izmaksātas ASV dolāros. Emitents patur tiesības izmaksāt dividendes arī citā valūtā vai kriptovalūtā. Jebkurš lēmums par dividenžu izmaksu tiks pieņemts saskaņā ar piemērojamiem tiesību aktiem un būs atkarīgs, cita starpā, no Emitenta darbības rezultātiem, finansiālā stāvokļa, līgumā noteiktajiem ierobežojumiem un kapitāla prasībām. Jebkurā gadījumā 5% no tīras peļņas tiks novirzīti likumā noteiktajām rezervēm, līdz tās sasniegs 10% apmaksātā pamatkapitāla.
<b>3.2</b>	<b>Kur tiks tirgoti vērtspapīri?</b>	
<b>3.2.1</b>	AWEARE Global Tokens nav atļauts tirgot regulētā tirgū. Emitents patur tiesības pieteikties iekļaušanai regulētā tirgū.	
<b>3.4</b>	<b>Kādi ir galvenie riski, kas raksturīgi vērtspapīriem?</b>	
<b>3.4.1</b>	<p><b>Investoru maku un privāto atslēgu risks</b>  Risku, kas saistīts ar maku vai privātās atslēgas atrašanās vietu, uzņemas tikai ieguldītājs. Ja tiek izmantots nesaderīgs maks vai ja privātā atslēga tiek pazaudēta, piekļuve AWEARE Global Tokens parasti nav iespējama. Sekas, piemēram, pilnīgs ieguldījuma zaudējums, ir jāuzņemas tikai un vienīgi ieguldītājam.</p> <p><b>Pārdodamības, likviditātes un realizācijas risks</b>  Nav pārliecības, ka AWEARE globālajiem žetoniem izveidosies likvids tirgus. Rezultātā AWEARE globālos žetonus nevar pārdot otrreizējā tirgū, radot likviditātes risku investoram.</p> <p><b>Svārstīguma risks</b>  Pastāv riski, kas saistīti ar akciju cenas svārstībām. Ja AWEARE Global Tokens tiktu pārdoti un tie nonāktu krasās cenu svārstībās, žetonu īpašnieks pārdošanas rezultātā varētu ciest zaudējumus, no kuriem daži varētu būt ievērojami.</p> <p><b>Žetonu zudums</b>  Žetoni var tikt pazaudēti vai kļūt nepieejami, jo īpaši, ja žetonu īpašnieks zaudē attiecīgo privāto atslēgu, lai atbrīvotos no saviem AWEARE Global Token, vai ja nepareizi darbojas e-portfelis, kurā tiek glabāti AWEARE Global Token. Tas var izraisīt Žetonu zaudēšanu. Žetonu īpašnieki ir pilnībā atbildīgi par privātas atslēgas, kas ļauj piekļūt e-naudas makam, drošu glabāšanu un aizsardzību. Žetoni var kļūt nepieejami arī Žetonu īpašnieka nāves gadījumā, ja viņš nav veicis pasākumus šādiem gadījumiem. Ne Emitents, ne kāda cita iestāde vai institūcija</p>	

	<p>nespēs atjaunot piekļuvi Token turētāja makam Token turētāja mantiniekiem. Turklāt privāto atslēgu zaudēšana var samazināt dažādu STO un AWEARE Global Token funkcionalitāšu pieejamību. Jo īpaši var būt neiespējami izsniegt AWEARE Global Token abonentiem vai padarīt tos nododamus, un tādā gadījumā tie paliktu apturēti uz nenoteiktu laiku. Turklāt var būt neiespējami veikt dividenžu maksājumus. Visbeidzot, pastāv risks, ka uzbrucējs var kaltēt AWEARE Global Tokens adresēm, kas neveic iemaksas, mainīt apstiprinājuma statusu, veikt nekontrolētas iemaksas STO vai ļaut uzbrucējam izņemt nepieprasītās dividendes.</p> <p><b>Ierobežotas žetonu īpašnieku tiesības</b> AWEARE globālie žetoni ir līdzdalības sertifikāti bez balsstiesībām, un tie nedod žetonu īpašniekiem tiesības balsot, sasaukt un piedalīties Emitenta akcionāru sapulcē. Turklāt AWEARE globālie žetoni nedod tiesības uz informāciju, pārbaudes tiesībām un tiesībām iesniegt pieteikumu. Tādēļ Emitenta pilnsapulce var pieņemt lēmumus, kas var nelabvēlīgi ietekmēt Žetonu turētāju tiesības. Žetonu turētājiem nav iespēju kontrolēt no AWEARE globālo žetonu emisijas iegūto līdzekļu izlietojumu. AWEARE globālo žetonu nodošanai (piemēram, nodošanai šaurā nozīmē, iekļāšanai, mantošanai) ir nepieciešama Emitenta valdes piekrišana. Jebkurā gadījumā AWEARE Global Tokens nodošana nav atļauta, ja tie nonāktu personas turējumā valstī, kurā AWEARE Global Tokens nedrīkst piedāvāt. Par nodošanu iepriekš minētajā nozīmē tiek uzskatīts arī tad, ja Token turētājs maina dzīvesvietu uz valsti, kurā AWEARE Global Tokens nedrīkst piedāvāt. Likumā noteiktās Žetonu turētāju parakstīšanās tiesības kapitāla palielināšanas gadījumā saskaņā ar šo piedāvājumu ir izslēgtas.</p> <p><b>Žetonu turētāju prasījumi ir pakārtoti</b> Žetonu turētāju tiesības pieprasīt un saņemt Emitenta dividendes ir pakārtotas visu Emitenta nesubordinēto saistību turētāju prasījumiem. Emitenta likvidācijas gadījumā Tokenholders saņems samaksu tikai tad un tikai pēc tam, kad būs izpildītas visas Emitenta prioritārās saistības.</p>
<b>IEDAĻA - GALVENĀ INFORMĀCIJA PAR VĒRTSPAPĪRU PUBLISKO PIEDĀVĀJUMU</b>	
4.1	<b>Ar kādiem nosacījumiem un grafiku es varu ieguldīt šajā vērtspapīrā?</b>
<p><b>Valstis, kurās tiek piedāvāti vērtspapīri</b> Piedāvājums ietver publiskus piedāvājumus Austrijā, Beļģijā, Bulgārijā, Čehijā, Dānijā, Francijā, Francijā, Grieķijā, Horvātijā, Kiprā, Igaunijā, Īrijā, Islandē, Īrijā, Itālijā, Latvijā, Lihtenšteinā, Lietuvā, Luksemburgā, Maltā, Nīderlandē, Norvēģijā, Polijā, Portugālē, Rumānijā, Slovākijā, Slovēnijā, Somijā, Spānijā, Ungārijā, Vācijā, Zviedrijā, Šveicē, kā arī privātus piedāvājumus atsevišķās jurisdikcijās ārpus šīm valstīm.</p> <p><b>Valstis, kurās vērtspapīri netiek piedāvāti</b> Emitenta AWEARE globālie žetoni nav un netiks reģistrēti saskaņā ar Amerikas Savienoto Valstu 1933. gada Likuma par vērtspapīriem ar grozījumiem noteikumiem vai Amerikas Savienoto Valstu štatu, Austrālijas, Japānas vai Kanādas vērtspapīru regulējošajās iestādēs. Attiecīgi tie netiks tieši vai netieši publiski piedāvāti, pārdoti vai piegādāti, izņemot saskaņā ar atbrīvojumu no reģistrācijas prasībām. Jo īpaši šis Prospekts nav uzskatāms par piedāvājumu pārdot vai aicinājumu izteikt piedāvājumu iegādāties AWEARE Global Tokens Amerikas Savienotajās Valstīs, Austrālijā, Japānā un Kanādā, un to nedrīkst izplatīt šajās valstīs. Turklāt šis Prospekts nav uzskatāms par piedāvājumu pārdot AWEARE Global Tokens Krievijā, Irānā, Ziemeļkorejā, Baltkrievijā, Sīrijā vai jebkurā to teritorijā. Un to nedrīkst izplatīt šajās valstīs.</p> <p><b>Piedāvājums</b> AWEARE Global Tokens parakstīšanās process notiks tiešsaistē vietnē <a href="https://kyc.awearetech.li/">https://kyc.awearetech.li/</a> ("Dashboard").</p> <p><b>Piedāvājuma periods</b> Periods, kurā investori var iesniegt savus pirkšanas piedāvājumus par AWEARE globālajiem žetoniem, sākas prospekta apstiprināšanas dienā un beidzas pēc gada ("Piedāvājuma periods"). Piedāvājuma perioda pēdējā dienā piedāvājumus var iesniegt līdz plkst. 12:00 pēc Lihtenšteinas laika.</p> <p><b>Piedāvātā cena</b> Viena AWEARE žetona cena ir <b>12,00 USD</b> ("Piedāvājuma cena").</p> <p>Lai veicinātu savlaicīgu investīciju veikšanu, ir pieejamas šādas atlaides:</p> <p>Ieguldījumiem no 10 000 USDC līdz 49 999,99 USDC investori saņems 10% atlaidi, tādējādi viena AWEARE žetona cena būs 10,80 USD.</p> <p>Ieguldot 50 000 USDC vai vairāk, investori saņems 15% atlaidi, tādējādi viena AWEARE žetona cena būs 10,20 USD.</p> <p><b>Atlaižu pieejamība</b> Iepriekš minētās atlaides ir pieejamas, līdz iestājas viens no turpmāk minētajiem gadījumiem, atkarībā no tā, kurš iestājas pirmais:</p> <ul style="list-style-type: none"> <li>• sasniežot kopējo ieguldījumu apjomu 5 000 000 USDC vai</li> <li>• trīs mēnešu laikā no piedāvājuma sākuma.</li> </ul> <p><b>Piegāde un norēķini</b> Katram ieguldītājam ir jāaizpilda tiešsaistes abonēšanas process vadības panelī. AWEARE Global Tokens tiks piešķirti ārpus ķēdes kā ieraksts Emitenta datubāzē, kas ir redzams Dashboard, pret Piedāvājuma cenas samaksu. AWEARE globālie žetoni tiks piešķirti ķēdes viedlīgumā vēlākais divu mēnešu laikā pēc Piedāvājuma perioda beigām. Kad būs beidzies</p>	

kopējais AWEARE Global Tokens piedāvājums (pēc mērķa līdzdalības kapitāla sasniegšanas) un Emitents būs nolēmis pabeigt Viedo līgumu, AWEARE Global Tokens tiks piegādāti investora kriptonauda makā.

#### Atšķaidīšana

Tā kā kapitāla palielināšanas gadījumā šā piedāvājuma kontekstā ir izslēgtas visu Dalībnieku likumā noteiktās parakstīšanās tiesības, šā piedāvājuma Dalībnieki netiks atšķaidīti.

#### Kopējie neto ieņēmumi un paredzamās emisijas izmaksas

Kopējie tīrie ieņēmumi no piedāvājuma, kas pārsniedz 1 400 000 AWEARE globālo žetonu, var sasniegt aptuveni **15 000 000 ASV dolāru**, kas atbilst līdzekļu piesaistes īstenošanai. Paredzamās kopējās piedāvājuma izmaksas ir aptuveni **USD 1 500 000**, un tās tiks segtas no iegūtajiem līdzekļiem.

<b>4.2</b>	<b>Kāpēc tiek sagatavots šis prospekts?</b>
<b>4.2.1</b>	<p>a) Paredzamie neto ieņēmumi no vērtspapīru emisijas galvenokārt tiks izmantoti pētniecībai un attīstībai un intelektuālā īpašuma aizsardzībai. Vajadzības gadījumā var būt nepieciešams līdz 50 % no piešķirtā budžeta pārcelt uz citu pozīciju.</p> <ul style="list-style-type: none"> <li>i) 10% paaugstināšanas izmaksas</li> <li>ii) 11% Vispārīgie un administratīvie izdevumi</li> <li>iii) 41% Pētniecība un izstrāde</li> <li>iv) 17% Juridiskā joma (globālā intelektuālā īpašuma aizsardzība)</li> <li>v) 21% Autobusu attīstība, pārdošana un mārketing</li> </ul> <p>b) AWEARE Technologies Inc. un Global Innovation Partners Limited pašreizējie akcionāri ir Mahesh Reddy un Dr. Daniel Hyman. Mahesh Reddy un Dr. Daniel Hyman ir arī Emitenta direktori un mazākuma akcionāri.</p> <p>c) Equanimity AG saņem darījuma maksu 3% apmērā no kopējās uzkrāto kriptovalūtu un fiat maksājumu summas. Marcell Füssinger (Marcel Füssinger), kurš ir viens no Emitenta direktoriem, ir arī Equanimity AG direktors un īpašnieks.</p> <p>d) <b>Kopējie neto ieņēmumi un paredzamās emisijas izmaksas</b> Kopējie tīrie ieņēmumi no piedāvājuma, kas pārsniedz 1 400 000 AWEARE globālo žetonu, var sasniegt aptuveni <b>15 000 000 ASV dolāru</b>, kas atbilst līdzekļu piesaistes īstenošanai. Paredzamās kopējās piedāvājuma izmaksas ir aptuveni <b>USD 1 500 000</b>, un tās tiks segtas no iegūtajiem līdzekļiem.</p> <p>e) <b>Apdrošināšanas līgumi</b> Piedāvājums nav pakļauts stingram parakstīšanas līgumam. Nav noslēgts līgums, saskaņā ar kuru parakstītājam būtu pienākums parakstīt nepārdotos žetonus. Tāpēc nav garantijas, ka tiks izvietots viss piedāvājums.</p>

## XV. PROSPEKTO SANTRAUKA

Šioje santraukoje pateikiami visi elementai, kuriuos reikia įtraukti į šios rūšies vertybinių popierių ir emitento santrauką.

1 SKIRSNIS - ĮVADAS		
<b>1.1</b>	<b>Vertybinių popierių pavadinimas ir ISIN kodas</b>	<b>1 400 000</b> naujų viešai platinamų akcijų sertifikatų yra "AWEARE Global AG" pareikštiniui akcijų sertifikatai be balso teisės. Šių dalyvavimo sertifikatų pavadinimas yra " <b>AWEARE Global Tokens</b> ". ISIN yra LI1363014385.
<b>1.2</b>	<b>Emitento tapatybė ir kontaktiniai duomenys, įskaitant jo juridinio asmens identifikatorių (LEI).</b>	<b>"AWEARE Global AG"</b> (toliau - <b>Emitentas</b> ) c/o Revalier Aktiengesellschaft Pradafant 11, 9490 Vaduz, Kunigaikštystė Tel.: +423 237 63 47 El. paštas: info@awearetech.li LEI yra: 391200PTNEZNXGJW1C39
<b>1.3</b>	<b>Kompetentinga institucija</b>	<b>Finansų rinkų institucija</b> (toliau - <b>FMA</b> ) Landstrasse 109, 9490 Vaducas, Lichtenšteino Kunigaikštystė Tel.: +423 236 73 73 73 Faksas: +423 236 73 74 El. paštas: <a href="mailto:info@fma-li.li">info@fma-li.li</a>

1.4	Prospekto patvirtinimo data	05/12/2024																		
1.5	Įspėjimai																			
1.5.1	<p>a) Santrauka turėtų būti skaitoma kaip šio Prospekto įvadas. Bet kokį sprendimą investuoti į vertybinius popierius investuotojas turėtų priimti išnagrinėjęs visą Prospektą.</p> <p>b) Investuotojas gali prarasti visą investuotą kapitalą arba jo dalį.</p> <p>c) Kai teisme pateikiamas ieškinys dėl prospekte pateiktos informacijos, pagal nacionalinę teisę ieškovui investuotojui gali tekti padengti prospekto vertimo prieš pradėdant teismo procesą išlaidas.</p> <p>d) Civilinė atsakomybė taikoma tik tiems asmenims, kurie pateikė santrauką, įskaitant bet kokį jos vertimą, tačiau tik tuo atveju, jei santrauka yra klaidinanti, netiksli ar nenuosekli, skaitant ją kartu su kitomis prospekto dalimis, arba jei joje, skaitant ją kartu su kitomis prospekto dalimis, nepateikiama pagrindinė informacija, padedanti investuotojams apsvarstyti, ar investuoti į vertybinius popierius.</p>																			
<b>2 SKIRSNIS - PAGRINDINĖ INFORMACIJA APIE EMITENTĄ</b>																				
2.1	Kas yra vertybinių popierių emitentas?																			
2.1.1	Informacija apie emitentą																			
	<p>a) Emitento teisinis ir komercinis pavadinimas yra "AWEARE Global AG". Emitentas yra Lichtenšteino Kunigaikštystėje įsteigta akcinė bendrovė, kuriai taikomi Lichtenšteino Kunigaikštystės įstatymai. Emitento registruota buveinė yra Vadūze, Lichtenšteino Kunigaikštystėje, ir jis įregistruotas Lichtenšteino Kunigaikštystės teisingumo tarnyboje / komerciniame registre registracijos numeriu FL-0002.714.015-4.</p> <p>b) Emitento tikslas - kurti ir pelningai naudoti jutiklių technologijas ir dirbtinį intelektą autonominiams transporto priemonėms ir kitoms reikmėms.</p> <p>c) Pagrindiniai Emitento akcininkai yra:</p> <ul style="list-style-type: none"> <li>• "Global Innovation Partners Limited", Britų Mergelių salos, kurios pagrindiniai akcininkai yra Dr. Daniel Hyman, Mahesh Reddy, Dr. Reginald Tang ir Mark Hyman.</li> </ul> <p>d) Emitento direktorių valdybą sudaro:</p> <ul style="list-style-type: none"> <li>• Dr. Daniel Hyman, pilietybė: JAV, Pašto adresas: adresas: Long Bičas, Kalifornija, JAV</li> <li>• Mahesh Reddy, pilietybė: JAV, Pašto adresas: Adresas: Irvinas, Kalifornija, JAV</li> <li>• Marcel Füssinger, pilietybė: Adresas: Austrija, Pašto adresas: Adresas: 160009, Singapūras</li> <li>• Revalier AG, atstovaujama Reinhold Wohlwend, pilietybė: Pašto adresas: Lichtenšteinas, adresas korespondencijai: Adresas: 9490, Vaducas, Lichtenšteinas</li> </ul> <p>e) Auditorius yra: Lucas Tihanyi, Lichtenšteino auditorių asociacijos narys ir EXPERTsuisse, Industriering 14, 9491 Ruggell, Lichtenstein</p>																			
2.2	Kokia yra pagrindinė emitento finansinė informacija?																			
2.2.1	<p>Emitentas buvo įsteigtas 2023-11-30 įrašu Lichtenšteino Kunigaikštystės komerciniame registre. Pagal 2023 m. spalio 25 d. Direktorių valdybos deklaraciją Emitentui netaikomas įprastinis auditas ir jam netaikoma audito peržiūra. Tačiau 2023 m. gruodžio 31 d. metinių finansinių ataskaitų ir 2023 m. liepos 15 d. tarpinių finansinių ataskaitų auditą atliko auditorius.</p> <p>Ši pagrindinė finansinė informacija parengta pagal Lichtenšteino Asmenų ir bendrovių įstatymo (toliau - PCL) nuostatas, visų pirma pagal jo 2 straipsnį. 1024 ir paskesniais straipsniais.</p> <p style="text-align: center;"><b>Pelno (nuostolių) ataskaita</b></p> <table border="1" style="width: 100%; border-collapse: collapse;"> <thead> <tr> <th></th> <th style="text-align: center;">31/12/2023</th> <th style="text-align: center;">15/07/2024</th> </tr> </thead> <tbody> <tr> <td><b>Visos pajamos</b></td> <td style="text-align: center;">0 JAV DOLERIŲ</td> <td style="text-align: center;">0 JAV DOLERIŲ</td> </tr> <tr> <td><b>Veiklos pelnas (nuostolis)</b></td> <td style="text-align: center;">USD -2'473,03</td> <td style="text-align: center;">USD -30'150,54</td> </tr> <tr> <td><b>Grynasis pelnas (nuostolis)</b></td> <td style="text-align: center;">USD -2'473,03</td> <td style="text-align: center;">USD -30'150,54</td> </tr> </tbody> </table> <p style="text-align: center;"><b>Balansas</b></p> <table border="1" style="width: 100%; border-collapse: collapse;"> <thead> <tr> <th></th> <th style="text-align: center;">31/12/2023</th> <th style="text-align: center;">15/07/2024</th> </tr> </thead> <tbody> <tr> <td><b>Visas turtas</b></td> <td style="text-align: center;">50'184,35 USD</td> <td style="text-align: center;">75'244,30 USD</td> </tr> </tbody> </table>			31/12/2023	15/07/2024	<b>Visos pajamos</b>	0 JAV DOLERIŲ	0 JAV DOLERIŲ	<b>Veiklos pelnas (nuostolis)</b>	USD -2'473,03	USD -30'150,54	<b>Grynasis pelnas (nuostolis)</b>	USD -2'473,03	USD -30'150,54		31/12/2023	15/07/2024	<b>Visas turtas</b>	50'184,35 USD	75'244,30 USD
	31/12/2023	15/07/2024																		
<b>Visos pajamos</b>	0 JAV DOLERIŲ	0 JAV DOLERIŲ																		
<b>Veiklos pelnas (nuostolis)</b>	USD -2'473,03	USD -30'150,54																		
<b>Grynasis pelnas (nuostolis)</b>	USD -2'473,03	USD -30'150,54																		
	31/12/2023	15/07/2024																		
<b>Visas turtas</b>	50'184,35 USD	75'244,30 USD																		



	<table border="1"> <tr> <td><b>Iš viso nuosavo kapitalo</b></td> <td>47 526,97 USD</td> <td>19'849,46 USD</td> </tr> <tr> <td><b>Grynoji finansinė skola (ilgalaikė skola plus trumpalaikė skola minus gryniesi pinigai)</b></td> <td>0 JAV DOLERIŲ</td> <td>0 JAV DOLERIŲ</td> </tr> </table> <p style="text-align: center;"><b>Pinigų srautų ataskaita</b></p> <table border="1"> <thead> <tr> <th></th> <th>31/12/2023</th> <th>15/07/2024</th> </tr> </thead> <tbody> <tr> <td><b>Atitinkami gryniesi pagrindinės veiklos pinigų srautai</b></td> <td>0 JAV DOLERIŲ</td> <td>0 JAV DOLERIŲ</td> </tr> <tr> <td><b>Atitinkami gryniesi investicinės veiklos pinigų srautai</b></td> <td>0 JAV DOLERIŲ</td> <td>0 JAV DOLERIŲ</td> </tr> <tr> <td><b>Atitinkami gryniesi finansinės veiklos pinigų srautai</b></td> <td>0 JAV DOLERIŲ</td> <td>0 JAV DOLERIŲ</td> </tr> </tbody> </table> <p>Emitento perspektyva nuo tarpinės balanso datos 2024 m. liepos 15 d. reikšmingai nepablogėjo. Nuo tarpinio balanso 2024 m. liepos 15 d. pateikimo dienos Emitento finansinė padėtis ar prekybos padėtis reikšmingai nepasikeitė.</p>	<b>Iš viso nuosavo kapitalo</b>	47 526,97 USD	19'849,46 USD	<b>Grynoji finansinė skola (ilgalaikė skola plus trumpalaikė skola minus gryniesi pinigai)</b>	0 JAV DOLERIŲ	0 JAV DOLERIŲ		31/12/2023	15/07/2024	<b>Atitinkami gryniesi pagrindinės veiklos pinigų srautai</b>	0 JAV DOLERIŲ	0 JAV DOLERIŲ	<b>Atitinkami gryniesi investicinės veiklos pinigų srautai</b>	0 JAV DOLERIŲ	0 JAV DOLERIŲ	<b>Atitinkami gryniesi finansinės veiklos pinigų srautai</b>	0 JAV DOLERIŲ	0 JAV DOLERIŲ
<b>Iš viso nuosavo kapitalo</b>	47 526,97 USD	19'849,46 USD																	
<b>Grynoji finansinė skola (ilgalaikė skola plus trumpalaikė skola minus gryniesi pinigai)</b>	0 JAV DOLERIŲ	0 JAV DOLERIŲ																	
	31/12/2023	15/07/2024																	
<b>Atitinkami gryniesi pagrindinės veiklos pinigų srautai</b>	0 JAV DOLERIŲ	0 JAV DOLERIŲ																	
<b>Atitinkami gryniesi investicinės veiklos pinigų srautai</b>	0 JAV DOLERIŲ	0 JAV DOLERIŲ																	
<b>Atitinkami gryniesi finansinės veiklos pinigų srautai</b>	0 JAV DOLERIŲ	0 JAV DOLERIŲ																	
<b>2.3</b>	<b>Kokia yra pagrindinė emitentui būdinga rizika?</b>																		
<b>2.3.1</b>	<p><b>Mažas kapitalas</b> Emitento tikslas - komercializuoti AWEARE technologiją. Emitento nuosavas kapitalas neviršija 50 000,00 JAV dolerių, kai pagal Lichtenšteino įstatymus reikalaujamas minimalus kapitalas yra 50 000,00 JAV dolerių. Kadangi Emitentas buvo įregistruotas 2023-11-30, nėra jokių reikšmingų istorinių finansinių duomenų ar pagrindinių skaičių, išskyrus šios santraukos 2.2.1 skirsnyje nurodytą istorinę finansinę informaciją, pagal kurią būtų galima įvertinti Emitento finansinę padėtį pastarųjų metų atžvilgiu. Emitentui netaikomas įprastinis auditas ir nėra atliekama audito peržiūra. Emitentas nebuvo įvertintas reitingų agentūros. Mažas nuosavas kapitalas kelia didesnę riziką investuotojui, nes atitinkamai sumažėja Emitento kaip atsakingo kapitalo funkcija.</p> <p><b>Nemokumo rizika</b> Jei Emitento turtui bus iškelta bankroto byla, Emitentui bus laikinai arba visam laikui apribotas disponavimas jo turtu arba disponavimą Emitento turtu perims teismo paskirtas bankroto administratorius. Tai gali turėti neigiamos įtakos Emitento finansinei būklei ir veiklai. Toks atvejis gali įvykti net ir tuo atveju, jei pareiškimai dėl nemokumo buvo pateikti neteisingai. Emitento nemokumo atveju Dalyviai atsako savo investuotą kapitalu. Investuotas kapitalas turi būti laikomas nuosavu kapitalu, todėl yra kvalifikuotai subordinuotas.</p> <p><b>Verslo finansavimas</b> Minimalaus kapitalo, kurį reikia surinkti, nėra. Nėra platinimo garantijos, o yra rizika, kad "AWEARE Global Tokens" nebus visiškai pasirašyti (platinimo rizika). Jei Emitentui nepavyks pritraukti norimo emisijos kiekio, Emitentas galės investuoti mažiau. Emitentui kyla kapitalo trūkumo rizika. Be to, išliks emisijos išlaidos, kurios nepriklauso nuo pritraukto kapitalo dydžio, todėl padidės išlaidų santykis, palyginti su visu pritraukto investicinio kapitalo dydžiu. Kyla rizika, kad tokiu atveju Emitentas nepasieks numatytų investavimo tikslų ir negalės įvykdyti savo įsipareigojimų pagal "AWEARE Global Tokens".</p> <p><b>Valdymas, technologijos, priklausomybė nuo trečiųjų šalių paslaugų teikėjų, konkurencija ir plėtros terminai</b> Viena iš pagrindinių Emitento stiprybių yra tai, kad jis sumaniai naudojami naujausiomis radarų technologijomis. Tačiau techniniai pranašumai informacinių ir ryšių technologijų pramonėje gali būti trumpalaikiai. Todėl emisijos sėkmė iš dalies priklausys nuo jos gebėjimo valdyti ir plėsti Emitento paslaugas ir didinti jo verslo vartotojų bazę, taigi ir gauti pajamų, atsižvelgiant į besikeičiančias technologijas, vartotojų ir trečiųjų šalių paslaugų teikėjų poreikius bei konkurencinį spaudimą. Nesugebėjimas ar vėlavimas tai padaryti gali neigiamai paveikti Emitento sėkmę.</p> <p><b>Žmogiškosios klaidos, susijusios su išmaniosiomis sutartimis</b> Emitentas neprisiima jokios atsakomybės ir neteikia jokių pareiškimų ar garantijų dėl Emitento projekto ar bet kokių išmaniųjų sutarčių, kurios gali būti užprogramuotos ar naudojamos atsiskaitymui už siūlymą pagal šį Prospektą plačiąja prasme, funkcionalumo. Dėl to investuotojai gali patirti nuostolių arba apskritai patirti visišką nuostolį. Tačiau tokiais scenarijais gali būti taikomi teisiniai mechanizmai, skirti apsaugoti investuotoją nuo nuostolių.</p>																		
<b>3 SKIRSNIS - PAGRINDINĖ INFORMACIJA APIE VERTYBINIUS POPIERIUS</b>																			
<b>3.1</b>	<b>Kokios yra pagrindinės vertybinių popierių savybės?</b>																		

3.1.1	<b>Informacija apie vertybinius popierius</b>	
a)	<b>Vertybinių popierių rūšies ir klasės aprašymas</b>	Emitento viešai siūlomi <b>1 400 000</b> naujų dalyvavimo sertifikatų - tai balsavimo teisės neturintys pareikštiniai dalyvavimo sertifikatai, kurių kiekvieno nominalioji vertė yra <b>0,01 JAV dolerio</b> dalyvavimo kapitalo (" <b>AWEARE Global Tokens</b> "), iš naujos dalyvavimo kapitalo emisijos, dėl kurios sprendimą priėmė neeilinis visuotinis akcininkų susirinkimas 2024-07-18. "AWEARE Global Tokens" turėtojai vadinami " <b>Dalyviais</b> " arba " <b>žetonų turėtojais</b> ".
b)	<b>Vertybinių popierių emisijos valiuta</b>	Jungtinių Amerikos Valstijų doleris (toliau - <b>USD</b> arba <b>\$</b> ). "AWEARE Global Token" galiojimo laikas yra neribotas.
c)	<b>Vertybinių popierių suteikiamų teisių aprašymas</b>	<p><b>Teisė balsuoti</b> "AWEARE Global Tokens" yra balsavimo teisės neturintys dalyvio sertifikatai, kurie nesuteikia teisės balsuoti, sušaukti ir dalyvauti Emitento visuotiniame susirinkime. Be to, "AWEARE Global Tokens" nesuteikia teisės gauti informaciją, teisės atlikti patikrinimą ir teisės pateikti prašymą. Tačiau visuotiniam susirinkimui gali būti pateiktas rašytinis prašymas suteikti informaciją, atlikti patikrinimą arba inicijuoti oficialų auditą.</p> <p><b>Pranešimas apie visuotinio susirinkimo sušaukimą ir nutarimus</b> Dalyviams turi būti pranešta apie visuotinio susirinkimo sušaukimą, kartu nurodant darbotvarkės klausimus ir pasiūlymus. Kiekvienas visuotinio susirinkimo nutarimas turi būti nedelsiant pateiktas Dalyviams susipažinti Emitento registruotoje buveinėje. Dalyviai apie tai informuojami pranešime.</p> <p><b>Teisė į dividendus ir likvidavimo pajamų dalis</b> "AWEARE Global Tokens" suteikia visas teises į dividendus nuo galiojančio įsigijimo dienos ir suteikia jų turėtojams teisę į likvidavimo pajamų dalį, proporcingą jų daliai dalyvavimo kapitale. Šiuo metu Emitentas neplanuoja artimiausiu metu skirstyti dividendų. Nors pagal įstatus egzistuoja reikalavimas gauti dividendus, jokių prognozių dėl dividendų paskirstymo ateityje nepateikiama. Emitentas ketina reinvestuoti pelną į tolesnį bendrovės augimą ir plėtrą.</p> <p><b>Forma ir pakeitimas vertybiniais popieriais</b> "AWEARE Global Tokens" bus išleisti kaip žetonai. Žetonai - tai vertės teisės, kurios išduodamos decentralizuotoje duomenų bazėje (Blockchain) ir ten perduodamos. Šiam tikslui naudojama "Blockchain" yra "Ethereum Blockchain".</p> <p><b>Pasirašymo teisių ir dalyvavimo teisių panaikinimas</b> Kol nepasiektas 50 000 JAV dolerių siektinas dalyvio kapitalas, pirmenybės teisės pagal PCL 304d, 304f ir 304g straipsnius, ypač dalyvių pasirašymo teisės ir dalyvavimo teisės, netaikomos.</p> <p><b>Vertybinių popierių perleidžiamumas</b> Norint perleisti (pvz., perduoti siaurąją prasme, įkeisti, paveldėti) "AWEARE Global Tokens" žetonus, reikalingas Emitento direktorių valdybos pritarimas. Todėl perleidžiamumas yra tam tikru mastu ribotas. Bet kuriuo atveju "AWEARE Global Tokens" perleidimas neleidžiamas, jei tokiu atveju juos turėtų asmuo šalyje, kurioje "AWEARE Global Tokens" negali būti siūlomi. Perleidimu pirmiau nurodyta prasme taip pat laikoma, jei žetono turėtojas perkelia savo gyvenamąją vietą į šalį, kurioje "AWEARE Global Tokens" negali būti siūlomi.</p>
d)	<b>Vertybinių popierių santykinė pirmenybė emitento kapitalo struktūroje nemokumo atveju</b>	Emitento nemokumo atveju dalyviai atsako savo investuotu kapitalu. Investuotas kapitalas turi būti laikomas nuosavu kapitalu, todėl yra kvalifikuotai subordinuotas.
e)	<b>Dividendų politikos aprašymas</b>	Iki šiol dividendai nebuvo išmokėti. Emitentas nepateikia jokių pelno prognozių ar vertinimų, todėl dividendų politikos aprašymas nepateikiamas. Dividendai, jei tokių bus, bus mokami JAV doleriais. Emitentas pasilieka teisę mokėti dividendus ir kita valiuta arba kriptovaliuta. Bet koks sprendimas išmokėti dividendus bus priimtas pagal galiojančius teisės aktus ir priklausys, inter alia, nuo Emitento veiklos rezultatų, finansinės padėties, sutartinių apribojimų ir kapitalo poreikio. Bet koku atveju 5 % grynojo pelno bus skiriama privalomiesiems rezervams, kol jie pasieks 10 % apmokėto akcinio kapitalo.
3.2	<b>Kur bus prekiaujama vertybiniais popieriais?</b>	
3.2.1	"AWEARE Global Tokens" žetonais nėra leidžiama prekiauti reguliuojamoje rinkoje. Emitentas pasilieka teisę kreiptis dėl įtraukimo į prekybos reguliuojamoje rinkoje sąrašą.	

3.4	<b>Kokia yra pagrindinė rizika, būdinga vertybiniais popieriams?</b>
3.4.1	<p><b>Investuotojų piniginės ir privataus rakto rizika</b> Investuotojas vienas prisiima riziką dėl piniginės pasirinkimo ar privataus rakto buvimo vietos. Jei naudojama nesuderinama piniginė arba prarandamas privatusis raktas, prieiga prie "AWEARE Global Tokens" paprastai neįmanoma. Tokias pasekmes, pavyzdžiui, visišką investicijos praradimą, turi prisiimti tik investuotojas.</p> <p><b>Pardavimo, likvidumo ir realizavimo rizika</b> Nėra jokio tikrumo, kad atsiras likvidi "AWEARE Global Tokens" rinka. Dėl to "AWEARE Global Tokens" nebus galima parduoti antrinėje rinkoje, todėl investuotojui kils likvidumo rizika.</p> <p><b>Kintamumo rizika</b> Akcijų kainos svyravimai yra susiję su rizika. Jei "AWEARE Global" žetonai būtų parduoti ir juos užkluptų staigus kainos svyravimas žemyn, žetono savininkas dėl pardavimo gali patirti nuostolių, kai kurie iš jų gali būti dideli.</p> <p><b>Žetonų praradimas</b> Žetonai gali būti prarasti arba tapti neprieinami, ypač jei žetono turėtojas praranda atitinkamą privatų raktą, kuriuo disponuoja savo AWEARE Global žetonais, arba dėl e. piniginės, kurioje saugomi AWEARE Global žetonai, veikimo sutrikimų. Dėl to žetonai gali būti prarasti. Tik žetonų turėtojai yra atsakingi už saugų privataus rakto, kuris suteikia prieigą prie e. piniginės, laikymą ir apsaugą. Žetonai gali tapti neprieinami ir žetonų turėtojo mirties atveju, jei jis ar ji tokiems atvejams nesiėmė priemonių. Nei Emitentas, nei jokia kita įstaiga ar institucija negalės atkurti prieigos prie žetono turėtojo piniginės žetono turėtojo įpėdinams. Be to, praradus privačius raktus, gali sumažėti galimybė naudotis įvairiomis STO ir "AWEARE Global Tokens" funkcijomis. Visų pirma gali būti neįmanoma išleisti "AWEARE Global Tokens" prenumeratoriams arba padaryti juos perleidžiamus, tokiu atveju jie liktų sustabdyti neribotam laikui. Be to, gali būti neįmanoma išmokėti dividendų. Galiausiai, yra rizika, kad užpuolikas gali nukaldinti "AWEARE Global Tokens" nepresidantiems adresatams, pakeisti patvirtinimo statusą, įnešti nekontroliuojamas sumas į STO arba leisti užpuolikui atsiimti neatsiimtus dividendų mokėjimus.</p> <p><b>Ribotos žetonų turėtojų teisės</b> AWEARE Global Tokens yra balsavimo teisės neturintys dalyvavimo sertifikatai ir nesuteikia žetonų turėtojams teisės balsuoti, sušaukti ir dalyvauti Emitento visuotiniame susirinkime. Be to, "AWEARE Global Tokens" nesuteikia teisės gauti informaciją, teisės atlikti patikrinimą ir teisės pateikti prašymą. Todėl Emitento visuotinis susirinkimas gali priimti nutarimus, kurie gali neigiamai paveikti žetonų turėtojų teises. Žetonų turėtojai neturi galimybės kontroliuoti pajamų, gautų išleidus "AWEARE Global Tokens", panaudojimo. AWEARE Global Tokens perleidimui (pavyzdžiui, perleidimui siaurąja prasme, įkeitimui, paveldėjimui) reikalingas Emitento valdybos pritarimas. Bet kuriuo atveju "AWEARE Global Tokens" perleidimas neleidžiamas, jei tokiu atveju juos turėtų asmuo šalyje, kurioje "AWEARE Global Tokens" negali būti siūlomi. Perleidimu pirmiau nurodyta prasme taip pat laikoma, jei žetonų turėtojas perkelia savo gyvenamąją vietą į šalį, kurioje "AWEARE Global Tokens" negali būti siūlomi. Įstatyminė žetonų turėtojų pasirašymo teisė kapitalo didinimo pagal šį pasiūlymą atveju netaikoma.</p> <p><b>Žetonų turėtojų reikalavimai yra subordinuoti</b> Žetonų turėtojų teisė reikalauti ir gauti Emitento dividendus yra mažesnė už visų Emitento nesubordinuotų įsipareigojimų turėtojų reikalavimus. Likviduojant Emitentą, Žetonų turėtojams bus sumokėta tik tuo atveju ir tik po to, kai bus įvykdyti visi Emitento pirmaeiliai įsipareigojimai.</p>
<b>4 SKIRSNIS - PAGRINDINĖ INFORMACIJA APIE VERTYBINIŲ POPIERIŲ SIŪLYMĄ VISUOMENEI</b>	
4.1	<b>Kokiomis sąlygomis ir terminais galiu investuoti į šį vertybinį popierių?</b>
<p><b>Šalys, kuriose siūlomi vertybiniai popieriai</b> Siūlymą sudaro vieši siūlymai Austrijoje, Belgijoje, Bulgarijoje, Čekijoje, Danijoje, Estijoje, Graikijoje, Graikijoje, Islandijoje, Ispanijoje, Airijoje, Italijoje, Kipre, Kroatijoje, Kipre, Latvijoje, Lichtenšteine, Lietuvoje, Liuksemburge, Maltoje, Nyderlanduose, Norvegijoje, Lenkijoje, Portugalijoje, Prancūzijoje, Rumunijoje, Slovakijoje, Slovėnijoje, Suomijoje, Švedijoje, Šveicarijoje, Vengrijoje, Vokietijoje, taip pat privatūs siūlymai tam tikrose jurisdikcijose už šių šalių ribų.</p> <p><b>Šalys, kuriose vertybiniai popieriai nėra siūlomi</b> Emitento "AWEARE Global Tokens" nėra ir nebus registruojami pagal 1933 m. Jungtinių Amerikos Valstijų vertybinių popierių įstatymo su pakeitimais nuostatas arba bet kurios Jungtinių Amerikos Valstijų valstijos, Australijos, Japonijos ar Kanados vertybinių popierių reguliavimo institucijų. Todėl jie nebus tiesiogiai ar netiesiogiai siūlomi, parduodami ar pristatomi visuomenei, išskyrus atvejus, kai taikoma išimtis iš registracijos reikalavimų. Visų pirma, šis Prospektas nėra pasiūlymas parduoti ar raginimas teikti pasiūlymą pirkti "AWEARE Global Tokens" Jungtinėse Amerikos Valstijose, Australijoje, Japonijoje ir Kanadoje ir negali būti jose platinamas. Be to, šis Prospektas nėra pasiūlymas parduoti ar raginimas teikti pasiūlymą pirkti "AWEARE Global Tokens" Rusijoje, Irane, Šiaurės Korėjoje, Baltarusijoje, Sirijoje ar bet kurioje jų teritorijoje. Ir negali būti jose platinamas.</p> <p><b>Siūlymas</b> "AWEARE Global" žetonų prenumeratos procesas vyks internete adresu <a href="https://kyc.awearetech.li/">https://kyc.awearetech.li/</a> ("Informacinis skydelis").</p> <p><b>Pasiūlymo laikotarpis</b></p>	

Laikotarpis, per kurį investuotojai gali teikti pasiūlymus pirkti "AWEARE Global Tokens", prasideda prospekto patvirtinimo dieną ir baigiasi po vienerių metų (toliau - **siūlymo laikotarpis**). Paskutinę Siūlymo laikotarpio dieną pasiūlymus galima teikti iki 12.00 val. vidurdienio Lichtenšteino laiku.

#### **Pasiūlymo kaina**

Vieno AWEARE žetono pasiūlymo kaina yra **12,00 USD** (toliau - **pasiūlymo kaina**).

Siekiant paskatinti ankstyvą investavimą, taikomos šios nuolaidos:

Investuodami nuo 10 000 USDC iki 49 999,99 USDC, investuotojai gaus 10 % nuolaidą, todėl vieno AWEARE žetono kaina bus 10,80 USD.

Investavus 50 000 USDC ar daugiau, investuotojai gaus 15 % nuolaidą, todėl vieno AWEARE žetono kaina bus 10,20 USD.

#### **Galimybė naudotis nuolaidomis**

Pirmiau nurodytos nuolaidos **taikomos tol, kol įvyksta viena iš toliau nurodytų aplinkybių, priklausomai nuo to, kuri iš jų įvyksta anksčiau:**

- **pasiekti bendrą 5 000 000 USDC investicijų sumą** arba
- **praėjus trims mėnesiams nuo pasiūlymo pradžios.**

#### **Pristatymas ir atsiskaitymas**

Kiekvienas investuotojas turi užbaigti internetinį prenumeratos procesą prietaisų skydelyje. AWEARE Global žetonai bus paskirstyti už grandinės ribų kaip įrašas Emitento duomenų bazėje, kurią galima matyti prietaisų skydelyje, sumokėjus siūlomą kainą. Ne vėliau kaip per du mėnesius nuo Siūlymo laikotarpio pabaigos "AWEARE Global" žetonai bus paskirstyti grandinėje (angl. on-chain) išmaniojoje sutartyje. Pasibaigus visam "AWEARE Global" žetonų siūlymo laikotarpiui (pasiekus tikslinį dalyvavimo kapitalą) ir Emitentui nusprendus užbaigti išmaniąją sutartį, "AWEARE Global" žetonai bus pristatyti į investuotojo kriptovaliutų piniginę.

#### **Skiedimas**

Kadangi kapitalo didinimo atveju pagal šį pasiūlymą visų dalyvių įstatyminė pasirašymo teisė netaikoma, šio pasiūlymo dalyviai nebus susilpninti.

#### **Visos grynosios įplaukos ir numatomos emisijos išlaidos**

Visos grynosios įplaukos, gautos pasiūlius daugiau nei 1 400 000 "AWEARE Global" žetonų, gali sudaryti apie **15 000 000 JAV dolerių**, atitinkančių lėšų pritraukimo įgyvendinimą. Numatomos bendros siūlymo išlaidos sudaro maždaug **1 500 000 JAV dolerių** ir bus padengtos iš gautų lėšų.

<b>4.2</b>	<b>Kodėl rengiamas šis prospektas?</b>
<b>4.2.1</b>	<p>a) Numatomos grynosios įplaukos iš vertybinių popierių emisijos pirmiausia bus naudojamos moksliniams tyrimams ir plėtrai bei intelektinės nuosavybės apsaugai. Prireikus gali prireikti iki 50 % skirto biudžeto perkelti į kitą poziciją.</p> <ul style="list-style-type: none"> <li>i) 10 % padidinimo sąnaudų</li> <li>ii) 11% Bendrosios ir administracinės paslaugos</li> <li>iii) 41% Moksliniai tyrimai ir plėtra</li> <li>iv) 17% Teisinė (visuotinė intelektinės nuosavybės apsauga)</li> <li>v) 21% Autobusų plėtra, pardavimai ir rinkodara</li> </ul> <p>b) Dabartiniai "AWEARE Technologies Inc." ir "Global Innovation Partners Limited" akcininkai yra Mahesh Reddy ir Dr. Daniel Hyman. Mahesh Reddy ir Dr. Daniel Hyman taip pat yra Emitento direktoriai ir smulkieji akcininkai.</p> <p>c) "Equanimity AG" gauna sandorio mokestį, kuris sudaro 3 % visų sukauptų kriptovaliutų ir fiat mokėjimų. Marcelis Füssingeris, kuris yra vienas iš Emitento direktorių, taip pat yra "Equanimity AG" direktorius ir savininkas.</p> <p>d) <b>Visos grynosios įplaukos ir numatomos emisijos išlaidos</b> Visos grynosios pajamos, gautos pasiūlius daugiau nei 1 400 000 "AWEARE Global" žetonų, gali sudaryti apie <b>15 000 000 JAV dolerių</b>, atitinkančių lėšų pritraukimo įgyvendinimą. Numatomos bendros siūlymo išlaidos sudaro maždaug <b>1 500 000 JAV dolerių</b> ir bus padengtos iš gautų lėšų.</p> <p>e) <b>Draudimo susitarimai</b> Siūlymui netaikomas tvirtas pasirašymo susitarimas. Nėra jokios sutarties, pagal kurią draudikas būtų įpareigotas pasirašyti neparduotus žetonus. Todėl nėra jokios garantijos, kad bus išplatintas visas siūlymas.</p>

## XVI. SAMMENDRAG AV PROSPEKTET

Dette sammendraget inneholder alle de elementene som kreves i et sammendrag for denne typen verdipapirer og utstedere.

DEL 1 - INNLEDNING		
1.1	Verdipapirenes navn og ISIN-kode	De <b>1 400 000</b> nye deltagersertifikatene som offentliggjøres, er ihendehaverdeltagelsessertifikater uten stemmerett i AWEARE Global AG. Navnet på disse deltakerbevisene er " <b>AWEARE Global Tokens</b> ". ISIN er LI1363014385.
1.2	Identitet og kontaktinformasjon til utstederen, inkludert identifikator for juridisk enhet (LEI)	<b>AWEARE Global AG ("Utstederen")</b> c/o Revalier Aktiengesellschaft Pradafant 11, 9490 Vaduz, Fyrstedømmet Tlf: +423 237 63 47 E-post: <a href="mailto:info@awearetech.li">info@awearetech.li</a> LEI-koden er 391200PTNEZNXGJW1C39
1.3	Kompetent myndighet	<b>Finansmarkedstilsynet ("FMA")</b> Landstrasse 109, 9490 Vaduz, Fyrstedømmet Liechtenstein Tlf: +423 236 73 73 Faks: +423 236 73 74 E-post: <a href="mailto:info@fma-li.li">info@fma-li.li</a>
1.4	Dato for godkjenning av prospektet	05/12/2024
1.5	Advarsler	
1.5.1		<p>a) Sammendraget bør leses som en introduksjon til dette Prospektet. Enhver beslutning om å investere i verdipapirene bør baseres på investorens vurdering av prospektet i sin helhet.</p> <p>b) Investoren kan tape hele eller deler av den investerte kapitalen.</p> <p>c) Dersom et krav knyttet til informasjon i prospektet bringes inn for en domstol, kan den saksøkende investor i henhold til nasjonal lovgivning måtte bære kostnadene ved å oversette prospektet før rettsaken innledes.</p> <p>d) Sivilt ansvar påhviler kun de personer som har lagt frem sammendraget, herunder eventuelle oversettelser av dette, men bare dersom sammendraget er villedende, unøyaktig eller inkonsekvent når det leses sammen med de øvrige delene av Prospektet, eller dersom det ikke gir nøkkelinformasjon når det leses sammen med de øvrige delene av Prospektet, for å hjelpe investorer når de vurderer om de skal investere i verdipapirene.</p>
AVSNITT 2 - NØKKELINFORMASJON OM UTSTEDEREN		
2.1	Hvem er utstederen av verdipapirene?	
2.1.1	Informasjon om utstederen	
		<p>a) Utstederens juridiske og kommersielle navn er "AWEARE Global AG". Utstederen er et allmennaksjeselskap stiftet i Fyrstedømmet Liechtenstein og underlagt lovene i Fyrstedømmet Liechtenstein. Utstederen har sitt hovedkontor i Vaduz, Fyrstedømmet Liechtenstein, og er registrert hos Office of Justice / Commercial Register of the Principality of Liechtenstein under registreringsnummer FL-0002.714.015-4.</p> <p>b) Utstederens formål er å utvikle og tjene penger på sensorteknologi og kunstig intelligens for selvkjørende kjøretøy og andre bruksområder.</p> <p>c) Utstederens hovedaksjonærer er: <ul style="list-style-type: none"> <li>Global Innovation Partners Limited, De britiske jomfruøyene, med majoritetsaksjonærene Dr. Daniel Hyman, Mahesh Reddy, Dr. Reginald Tang og Mark Hyman</li> </ul> </p> <p>d) Utstederens styre består av følgende medlemmer: <ul style="list-style-type: none"> <li>Dr. Daniel Hyman, nasjonalitet: USA, Postadresse: Long Beach, California, USA</li> <li>Mahesh Reddy, nasjonalitet: USA, Postadresse: Irvine, California, USA</li> <li>Marcel Füssinger, nasjonalitet: Østerrike, Postadresse: 160009, Singapore</li> <li>Revalier AG representert ved Reinhold Wohlwend, nasjonalitet: Liechtenstein, postadresse 9490, Vaduz, Liechtenstein</li> </ul> </p> <p>e) Revisor er Lucas Tihanyi, medlem av Liechtensteins revisorforening og EXPERTsuisse, Industriering 14, 9491 Ruggell, Liechtenstein</p>
2.2	Hva er den viktigste finansielle informasjonen om utstederen?	

Utstederen ble stiftet den 30/11/2023 ved registrering i handelsregisteret i Fyrstedømmet Liechtenstein. I henhold til styrets erklæring datert 25. oktober 2023 er Utstederen ikke underlagt ordinær revisjon og er ikke gjenstand for revisjonsgjennomgang. Årsregnskapet per 31. desember 2023 og delårsregnskapet per 15. juli 2023 ble imidlertid revidert av revisor.

Følgende nøkkelinformasjon er utarbeidet i samsvar med bestemmelsene i Liechtensteins person- og selskapslov ("PCL"), særlig art. 1024 ff.

### Resultatregnskap

	31/12/2023	15/07/2024
<b>Totale inntekter</b>	USD 0	USD 0
<b>Driftsresultat</b>	USD -2'473,03	USD -30'150,54
<b>Netto resultat</b>	USD -2'473,03	USD -30'150,54

### Balanseregnskap

	31/12/2023	15/07/2024
<b>Sum eiendeler</b>	USD 50'184,35	USD 75'244,30
<b>Total egenkapital</b>	USD 47 526,97	USD 19'849,46
<b>Netto finansiell gjeld (langsigtig gjeld pluss kortsiktig gjeld minus kontanter)</b>	USD 0	USD 0

### Kontantstrømoppstilling

	31/12/2023	15/07/2024
<b>Relevant netto kontantstrøm fra operasjonelle aktiviteter</b>	USD 0	USD 0
<b>Relevant netto kontantstrøm fra investeringsaktiviteter</b>	USD 0	USD 0
<b>Relevant netto kontantstrøm fra finansieringsaktiviteter</b>	USD 0	USD 0

Utstederens utsikter har ikke forverret seg vesentlig siden datoen for delårsbalansen per 15.07.2024. Det har ikke vært noen vesentlige endringer i Utstederens finansielle stilling eller handelsposisjon siden rapporteringsdatoen for delårsbalansen per 15.07.2024.

**2.3** Hva er de viktigste risikoene som er spesifikke for utstederen?

**2.3.1** **Lav kapital**  
Utstederens formål er kommersialisering av AWEAREs teknologi. Utstederens egenkapital er begrenset til USD 50.000,00, hvor minimumskapitalkravet etter liechtensteinsk rett er USD 50.000,00. Ettersom Utstederen ble stiftet den 30.11.2023, er ingen vesentlige historiske finansielle data eller nøkkeltall, bortsett fra den historiske finansielle informasjonen som er nevnt i avsnitt 2.2.1 i dette sammendraget, tilgjengelig for å vurdere Utstederens finansielle situasjon i forhold til de siste årene. Utstederen er ikke underlagt ordinær revisjon og har ikke revisjonsberetning. Utstederen har ikke blitt vurdert av et ratingbyrå. Lav egenkapital representerer en økt risiko for investor, da funksjonen som ansvarlig kapital reduseres tilsvarende.

**Insolvensrisiko**  
Dersom det åpnes insolvensbehandling over Utstederens eiendeler, vil Utstederen midlertidig eller permanent være begrenset i avhendingen av sine eiendeler, eller avhendingen av Utstederens eiendeler vil bli overtatt av en rettsoppnevnt insolvensadministrator. Dette kan ha en negativ innvirkning på Utstederens finansielle stilling og forretningsvirksomhet. Dette kan skje selv om insolvensbegjæringen er innlevert på feilaktig grunnlag. I tilfelle insolvens hos Utstederen, er Deltakerne ansvarlige med sin investerte kapital. Den investerte kapitalen skal behandles som egenkapital og er derfor kvalifisert etterstilt.

	<p><b>Finansiering av virksomheten</b></p> <p>Det er ingen minimumskapital som skal innhentes. Det er ingen plasseringsgaranti, men risiko for at AWEARE Global Tokens ikke blir fulltegnet (plasseringsrisiko). Dersom Utstederen ikke lykkes med å oppnå det ønskede emisjonsvolumet, vil Utstederen kunne investere mindre. Det er en risiko for kapitalmangel for Utstederen. I tillegg vil emisjonskostnadene, som er uavhengige av hvor mye kapital som hentes inn, forbli, noe som vil øke kostnadsandelen i forhold til den totale investeringskapitalen som hentes inn. Det er en risiko for at Utstederen i dette tilfellet ikke vil oppnå sine tiltenkte investeringsmål og ikke vil være i stand til å oppfylle sine forpliktelser i henhold til AWEARE Global Tokens.</p> <p><b>Ledelse, teknologi, avhengighet av tredjepartsleverandører, konkurranse og tidsrammer for utvikling</b></p> <p>En av utstederens viktigste styrker er den smarte bruken av den nyeste radarteknologien. Tekniske fordeler i informasjons- og kommunikasjonsteknologibransjen kan imidlertid være kortvarige. Følgelig vil emisjonens suksess delvis avhenge av dens evne til å administrere og utvide utstederens tjenester og øke virksomhetens brukerbase og dermed generere inntekter som svar på skiftende teknologier, brukernes og tredjeparts tjenesteleverandørers krav og konkurransepress. Hvis dette mislykkes eller forsinkes, kan det ha en negativ innvirkning på Utstederens suksess.</p> <p><b>Menneskelige feil med smartkontrakter</b></p> <p>Utstederen påtar seg intet ansvar og gir ingen garantier med hensyn til funksjonaliteten til Utstederens prosjekt eller til eventuelle smartkontrakter som kan programmeres eller brukes til oppgjør av tilbudet i samsvar med dette prospektet i videste forstand. Investorer kan lide verdifall som følge av dette eller generelt stå overfor et totaltap. I slike scenarier kan imidlertid juridiske mekanismer gjelde for å beskytte en investor mot tap.</p>	
<b>AVSNITT 3 - NØKKELINFORMASJON OM VERDIPAPIRENE</b>		
3.1	Hva er hovedtrekkene ved verdipapirene?	
3.1.1	Informasjon om verdipapirene	
a)	<b>Beskrivelse av verdipapirenes type og klasse</b>	De 1 400 000 nye deltakerbevisene som tilbys offentlig av Utstederen er deltakerbevis uten stemmerett, hver med en pålydende verdi på <b>USD 0,01</b> av deltakerkapitalen (" <b>AWEARE Global Tokens</b> "), fra en nyemisjon av deltakerkapital vedtatt av en ekstraordinær generalforsamling den 18.07.2024. Innehavere av AWEARE Global Tokens kalles " <b>Deltakere</b> " eller " <b>Tokenholdere</b> ".
b)	<b>Valuta for utstedelse av verdipapirer</b>	Amerikanske dollar (" <b>USD</b> " eller " <b>\$</b> "). Løpetiden for AWEARE Global Token er ubegrenset.
c)	<b>Beskrivelse av rettighetene knyttet til verdipapirene</b>	<p><b>Stemmerett</b></p> <p>AWEARE Global Tokens er deltakerbevis uten stemmerett og gir ikke rett til å stemme på, innkalle til eller delta i generalforsamlingen i Utstederen. Videre gir AWEARE Global Tokens ikke rett til informasjon, innsynsrett eller rett til å fremsette en søknad. En skriftlig anmodning om informasjon eller inspeksjon eller om igangsettelse av en offisiell revisjon kan imidlertid sendes til generalforsamlingen.</p> <p><b>Kunngjøring av innkalling til og vedtak på generalforsamlingen</b></p> <p>Deltakerne skal varsles om innkalling til generalforsamlingen sammen med sakene på dagsordenen og forslagene. Alle vedtak på generalforsamlingen skal uten opphold gjøres tilgjengelig for inspeksjon av Deltakerne på Utstederens hovedkontor. Deltakerne skal informeres om dette i innkallingen.</p> <p><b>Rett til utbytte og andel av likvidasjonsprovenyet</b></p> <p>AWEARE Global Tokens har full rett til utbytte fra datoen for gyldig erverv og gir innehaverne rett til en andel av likvidasjonsprovenyet i forhold til deres andel av andelskapitalen. Utstederen planlegger for tiden ikke å utbetale utbytte i nær fremtid. Selv om det foreligger et krav på utbytte i henhold til vedtektene, er det ikke laget noen prognoser for fremtidige utbytteutdelinger. Utstederen har til hensikt å reinvestere overskudd i videre vekst og utvikling av selskapet.</p> <p><b>Form og verdipapirisering</b></p> <p>AWEARE Global Tokens vil bli utstedt som tokens. Tokens er verdirettigheter som utstedes på en desentralisert database (Blockchain) og overføres dit. Blockchain som brukes til dette formålet er Ethereum Blockchain.</p> <p><b>Utelukkelse av tegnings- og deltakerrettigheter</b></p> <p>Inntil deltakerkapitalen på USD 50 000 er nådd, er fortrinnsrettighetene i henhold til artikkel 304d, 304f og 304g i PCL, særlig deltakernes tegningsretter og deltakerrettigheter, utelukket.</p> <p><b>Overførbarhet av verdipapirene</b></p> <p>Overdragelse (for eksempel overdragelse i snever forstand, pantsettelse, arv) av AWEARE Global Tokens krever godkjenning av Utsteders styre. Overførbarheten</p>

		er derfor begrenset til en viss grad. En overføring av AWEARE Global Tokens er uansett ikke tillatt dersom de i så fall vil bli eid av en person i et land hvor AWEARE Global Tokens ikke kan tilbys. En overføring i ovennevnte forstand anses også å skje dersom en Tokenholder flytter sin bopel til et land hvor AWEARE Global Tokens ikke kan tilbys.
d)	<b>Verdipapirenes relative prioritet i utstederens kapitalstruktur i tilfelle insolvens</b>	I tilfelle insolvens hos Utstederen, er Deltakerne ansvarlige med sin investerte kapital. Den investerte kapitalen skal behandles som egenkapital og er derfor kvalifisert etterstilt.
e)	<b>Beskrivelse av utbyttepolitikken</b>	Det er ikke utbetalt utbytte til dags dato. Utstederen utarbeider ikke resultatprognoser eller estimater, og det gis derfor ingen beskrivelse av utbyttepolitikken. Eventuelle utbytter vil bli utbetalt i USD. Utstederen forbeholder seg retten til å betale utbytte også i en annen valuta eller kryptovaluta. Eventuelle beslutninger om å utbetale utbytte vil bli fattet i samsvar med gjeldende lovgivning og vil blant annet avhenge av Utstederens driftsresultater, finansielle stilling, kontraktsmessige begrensninger og kapitalkrav. Under alle omstendigheter vil 5 % av nettoresultatet bli avsatt til de lovbestemte reservene inntil dette har nådd 10 % av den innbetalte aksjekapitalen.
<b>3.2</b>	<b>Hvor vil verdipapirene bli omsatt?</b>	
<b>3.2.1</b>	AWEARE Global Tokens er ikke tatt opp til handel på et regulert marked. Utstederen forbeholder seg retten til å søke om opptak til handel på et regulert marked.	
<b>3.4</b>	<b>Hva er de viktigste risikoene som er spesifikke for verdipapirene?</b>	
<b>3.4.1</b>	<p><b>Risiko knyttet til investorenes lommebok og private nøkler</b> Investoren bærer alene risikoen for valg av lommebok eller plasseringen av den private nøkkelen. Hvis en inkompatibel lommebok brukes eller hvis den private nøkkelen går tapt, er det normalt umulig å få tilgang til AWEARE Global Tokens. Konsekvensene, som for eksempel totaltap av investeringen, må alene bæres av investoren.</p> <p><b>Risiko for salgbarhet, likviditet og realisasjonsrisiko</b> Det er ingen sikkerhet for at det vil utvikle seg et likvid marked for AWEARE Global Tokens. Som et resultat av dette vil AWEARE Global Tokens ikke kunne selges på et annenhåndsmarked, noe som skaper likviditetsrisiko for investoren.</p> <p><b>Volatilitetsrisiko</b> Det er risiko forbundet med volatiliteten i aksjekursen. Hvis AWEARE Global Tokens skulle bli solgt og de skulle bli fanget i en kraftig nedadgående kurssvingning, kan Tokeninnehaveren lide tap, hvorav noen kan være betydelige, som et resultat av salget.</p> <p><b>Tap av poletter</b> Tokens kan gå tapt eller bli utilgjengelige, spesielt hvis Tokeninnehaveren mister den respektive private nøkkelen til å disponere sine AWEARE Global Tokens eller på grunn av funksjonsfeil i e-lommeboken som AWEARE Global Tokens er lagret i. Dette kan resultere i tap av Tokens. Det er Tokenholders eget ansvar å oppbevare og beskytte den private nøkkelen som gir tilgang til e-lommeboken på en sikker måte. Tokenene kan bli utilgjengelige også i tilfelle en Tokenholder dør, hvis han eller hun ikke har tatt forholdsregler for slike tilfeller. Verken Utstederen eller noe annet organ eller institusjon vil være i stand til å gjenopprette tilgangen til Tokenholderens lommebok for Tokenholderens etterfølgere. Tapet av private nøkler kan videre redusere tilgjengeligheten av ulike funksjoner i STO-en og AWEARE Global Tokens. Spesielt kan det være umulig å utstede AWEARE Global Tokens til abonnenter eller å gjøre dem overførbare, i hvilket tilfelle de vil forbli pauset på ubestemt tid. Videre kan det være umulig å utbetale utbytte. Endelig er det en risiko for at en angriper kan utstede AWEARE Global Tokens til adresser som ikke bidrar, endre bekreftelsesstatus, bidra med ukontrollerte beløp til STO-en eller tillate angriperen å ta ut uavhentede utbyttebetalinger.</p> <p><b>Begrensede rettigheter for Tokenholder</b> AWEARE Global Tokens er deltakerbevis uten stemmerett og gir ikke Tokenholderne rett til å stemme på, innkalle til og delta på generalforsamlingen i Utstederen. Videre gir AWEARE Global Tokens ikke rett til informasjon, innsynsrett eller rett til å fremsette begjæring. Utstederens generalforsamling kan derfor vedta vedtak som kan påvirke Tokenholdernes rettigheter negativt. Tokenholdere har ingen mulighet til å kontrollere bruken av provenyet fra utstedelsen av AWEARE Global Tokens. Overdragelse (for eksempel overdragelse i snever forstand, pantsettelse, arv) av AWEARE Global Tokens krever godkjenning av Utsteders styre. Overdragelse av AWEARE Global Tokens er uansett ikke tillatt dersom de i så fall vil bli eid av en person i et land hvor AWEARE Global Tokens ikke kan tilbys. En overføring i ovennevnte forstand anses også å skje dersom en Tokenholder flytter sin bopel til et land hvor AWEARE Global Tokens ikke kan tilbys. Den lovbestemte tegningsretten til Tokenholderne i tilfelle en kapitalforhøyelse under dette tilbudet er utelukket.</p> <p><b>Tokenholdernes krav er etterstilt</b> Tokenholdernes rett til å kreve og motta utbyttebetalinger fra Utstederen er etterstilt kravene til alle innehavere av</p>	



	ikke-etterstilte forpliktelser hos Utstederen. I en likvidasjon av Utstederen vil Tokenholderne kun bli betalt hvis og etter at alle Utstederens seniorforpliktelser er innfridd.
<b>AVSNITT 4 - NØKKELINFORMASJON OM TILBUDET AV VERDIPAPIRER TIL ALLMENNHETEN</b>	
<b>4.1</b>	<b>Under hvilke betingelser og etter hvilken tidsplan kan jeg investere i dette verdipapiret?</b>
	<p><b>Land hvor verdipapirene tilbys</b> Tilbudet består av offentlige tilbud i Belgia, Bulgaria, Danmark, Estland, Finland, Frankrike, Hellas, Irland, Island, Italia, Kroatia, Latvia, Liechtenstein, Litauen, Luxembourg, Malta, Nederland, Norge, Polen, Portugal, Romania, Slovakia, Slovenia, Spania, Sveits, Sverige, Tsjekkia, Tyskland, Ungarn, Østerrike, Polen, Portugal, Romania, Slovakia, Slovenia, Sverige, Sveits og Kypros, samt private plasseringer i visse jurisdiksjoner utenfor disse landene.</p> <p><b>Land der verdipapirene ikke tilbys</b> Utstederens AWEARE Global Tokens er ikke og vil ikke bli registrert i henhold til bestemmelsene i United States Securities Act av 1933, med endringer, eller hos verdipapirtilsynsmyndighetene i noen delstat i USA, eller i Australia, Japan eller Canada. Følgelig vil de ikke bli tilbudt, solgt eller levert direkte eller indirekte til allmennheten, unntatt i henhold til et unntak fra registreringskravene. Dette Prospektet utgjør ikke et tilbud om å selge eller en oppfordring til å kjøpe AWEARE Global Tokens i USA, Australia, Japan og Canada, og kan ikke distribueres der. I tillegg utgjør dette Prospektet ikke et tilbud om å selge eller en oppfordring til å kjøpe AWEARE Global Tokens i Russland, Iran, Nord-Korea, Hviterussland, Syria eller noen territorier der. Og kan ikke distribueres der.</p> <p><b>Budgivning</b> Tegningsprosessen for AWEARE Global Tokens vil foregå online på <a href="https://kyc.awearetech.li/">https://kyc.awearetech.li/</a> ("Dashboard").</p> <p><b>Tilbudsperiode</b> Perioden hvor investorer kan inngi tilbud om kjøp av AWEARE Global Tokens begynner på datoen for godkjenning av Prospektet og avsluttes ett år senere ("<b>Tilbudsperioden</b>"). På den siste dagen i Tilbudsperioden kan det inngis tilbud frem til kl. 12:00 norsk tid.</p> <p><b>Budpris</b> Budprisen for ett AWEARE Token er <b>USD 12,00</b> ("<b>Budprisen</b>").</p> <p>For å oppmuntre til tidlig investering er følgende rabatter tilgjengelige:</p> <p>For investeringer mellom 10 000 USDC og 49 999,99 USDC vil investorer få en rabatt på 10 %, slik at prisen per AWEARE Token blir 10,80 USD.</p> <p>For investeringer på 50 000 USDC eller mer vil investorer få en rabatt på 15 %, slik at prisen per AWEARE Token blir 10,20 USD.</p> <p><b>Tilgjengelighet av rabatter Rabattene</b> ovenfor er tilgjengelige <b>frem til en av følgende hendelser inntreffer, avhengig av hva som kommer først:</b></p> <ul style="list-style-type: none"> <li>• når et samlet investeringsvolum på 5 000 000 USDC, eller</li> <li>• utløpet av tre måneder fra tilbudets start.</li> </ul> <p><b>Levering og oppgjør</b> Hver investor må fullføre den elektroniske tegningsprosessen på Dashboardet. AWEARE Global Tokens vil bli allokert off-chain som en post i Utsteders database, som kan sees via Dashboardet, mot betaling av Budprisen. AWEARE Global Tokens vil bli allokert on-chain i Smart Contract senest innen to måneder etter utløpet av Tilbudsperioden. Når det totale tilbudet av AWEARE Global Tokens (etter å ha nådd målet for deltakerkapital) er avsluttet og Utsteder har besluttet å ferdigstille Smart Contract, vil AWEARE Global Tokens bli levert til investorens kryptolommebok.</p> <p><b>Fortynning</b> Siden den lovbestemte tegningsretten til alle deltakerne er utelukket i tilfelle en kapitalforhøyelse i forbindelse med dette tilbudet, vil deltakerne i dette tilbudet ikke bli utvannet.</p> <p><b>Samlet nettoproveny og estimerte emisjonskostnader</b> Det totale nettoprovenyet av tilbudet over 1 400 000 AWEARE Global Tokens kan beløpe seg til ca. <b>USD 15 000 000</b>, tilsvarende gjennomføringen av kapitalinnhenting. De forventede totale kostnadene ved tilbudet vil beløpe seg til ca. <b>USD 1 500 000</b> og vil bli belastet fra provenyet.</p>
<b>4.2</b>	<b>Hvorfor utarbeides dette prospektet?</b>
<b>4.2.1</b>	a) Det anslåtte nettoprovenyet fra utstedelsen av verdipapirene vil primært bli brukt til forskning og utvikling og beskyttelse av immaterielle rettigheter. Det kan bli nødvendig å flytte opptil 50 % av et tildelt budsjett til en annen stilling om nødvendig.

	<ul style="list-style-type: none"> <li>i) 10 % av kostnaden for økningen</li> <li>ii) 11% Generelt og administrativt</li> <li>iii) 41 % Forskning og utvikling</li> <li>iv) 17 % Juridisk (global beskyttelse av immaterielle rettigheter)</li> <li>v) 21 % Bus Dev, salg og markedsføring</li> </ul> <p>b) De nåværende aksjonærene i AWEARE Technologies Inc. og Global Innovation Partners Limited inkluderer Mahesh Reddy og Dr. Daniel Hyman. Mahesh Reddy og Dr. Daniel Hyman er også styremedlemmer og minoritetsaksjonærer i Utstederen.</p> <p>c) Equanimity AG mottar et transaksjonsgebyr på 3 % av de totale kryptovalutaene og fiat-betalingene som påløper. Marcel Füssinger, som er en av styremedlemmene i utstederen, er også styremedlem og eier av Equanimity AG.</p> <p>d) <b>Samlet nettoproveny og estimerte emisjonskostnader</b>  Det totale nettoprovenyet av tilbudet over 1 400 000 AWEARE Global Tokens kan beløpe seg til ca. <b>USD 15 000 000</b> tilsvarende gjennomføringen av kapitalinnhenting. De forventede totale kostnadene ved tilbudet vil beløpe seg til ca. <b>USD 1 500 000</b> og vil bli belastet fra provenyet.</p> <p>e) <b>Underwriting-ordninger</b>  Tilbudet er ikke underlagt en fast garantiavtale. Det foreligger ingen avtale som forplikter en garantist til å garantere for usolgte tokens. Det er derfor ingen garanti for at hele tilbudet vil bli plassert.</p>
--	--

## XVII. PODSUMOWANIE PROSPEKTU EMISYJNEGO

Niniejsze podsumowanie zawiera wszystkie elementy wymagane w podsumowaniu dla tego typu papierów wartościowych i emitenta.

SEKCJA 1 - WPROWADZENIE		
1.1	Nazwa i ISIN papierów wartościowych	1 400 000 nowych publicznych certyfikatów uczestnictwa to certyfikaty na okaziciela AWEARE Global AG bez prawa głosu. Nazwa tych certyfikatów uczestnictwa to "AWEARE Global Tokens". Numer ISIN to LI1363014385.
1.2	Dane identyfikacyjne i kontaktowe emitenta, w tym jego identyfikator podmiotu prawnego (LEI)	<b>AWEARE Global AG ("Emitent")</b> c/o Revalier Aktiengesellschaft Pradafant 11, 9490 Vaduz, Księstwo Tel: +423 237 63 47 E-mail: <a href="mailto:info@awearetech.li">info@awearetech.li</a> LEI to: 391200PTNEZNXGJW1C39
1.3	Właściwy organ	<b>Urząd Nadzoru nad Rynkiem Finansowym ("FMA")</b> Landstrasse 109, 9490 Vaduz, Księstwo Liechtensteinu Tel: +423 236 73 73 Faks: +423 236 73 74 E-mail: <a href="mailto:info@fma-li.li">info@fma-li.li</a>
1.4	Data zatwierdzenia prospektu emisyjnego	05/12/2024
1.5	Ostrzeżenia	
1.5.1	<ul style="list-style-type: none"> <li>a) Podsumowanie należy traktować jako wprowadzenie do niniejszego Prospektu. Inwestor powinien podjąć decyzję o zainwestowaniu w papiery wartościowe na podstawie całości Prospektu.</li> <li>b) Inwestor może stracić całość lub część zainwestowanego kapitału.</li> <li>c) W przypadku wniesienia do sądu roszczenia dotyczącego informacji zawartych w prospekcie emisyjnym, powodowy inwestor może, zgodnie z prawem krajowym, być zmuszony do poniesienia kosztów tłumaczenia prospektu emisyjnego przed wszczęciem postępowania sądowego.</li> <li>d) Odpowiedzialność cywilna dotyczy tylko tych osób, które przedstawiły podsumowanie, w tym jego tłumaczenie, ale tylko wtedy, gdy podsumowanie wprowadza w błąd, jest niedokładne lub niespójne, gdy jest czytane łącznie z innymi częściami Prospektu Emisyjnego, lub nie zawiera, gdy jest czytane łącznie z innymi częściami Prospektu Emisyjnego, kluczowych informacji mających pomóc inwestorom w podjęciu decyzji o zainwestowaniu w papiery wartościowe.</li> </ul>	
SEKCJA 2 - KLUCZOWE INFORMACJE O EMITENCIE		

2.1	<b>Kto jest emitentem papierów wartościowych?</b>																														
2.1.1	<b>Informacje o emitencie</b>																														
	<p>a) Prawną i handlową nazwą Emitenta jest "AWEARE Global AG". Emitent jest spółką akcyjną zarejestrowaną w Księstwie Liechtensteinu i podlegającą prawu Księstwa Liechtensteinu. Emitent ma siedzibę w Vaduz, Księstwo Liechtensteinu i jest zarejestrowany w Urzędzie Sprawiedliwości / Rejestrze Handlowym Księstwa Liechtensteinu pod numerem rejestracyjnym FL-0002.714.015-4.</p> <p>b) Celem Emitenta jest rozwój i monetyzacja technologii czujników i sztucznej inteligencji dla pojazdów autonomicznych i innych zastosowań.</p> <p>c) Głównymi akcjonariuszami Emitenta są:</p> <ul style="list-style-type: none"> <li>• Global Innovation Partners Limited z siedzibą na Brytyjskich Wyspach Dziewiczych, której większościami udziałowcami są dr Daniel Hyman, Mahesh Reddy, dr Reginald Tang i Mark Hyman.</li> </ul> <p>d) W skład Rady Dyrektorów Emitenta wchodzi:</p> <ul style="list-style-type: none"> <li>• Dr Daniel Hyman, Narodowość: Stany Zjednoczone, Adres do korespondencji: Long Beach, Kalifornia, USA</li> <li>• Mahesh Reddy, Narodowość: Stany Zjednoczone, Adres do korespondencji: Irvine, Kalifornia, USA</li> <li>• Marcel Füssinger, Narodowość: Austria, Adres do korespondencji: 160009, Singapur</li> <li>• Revalier AG reprezentowany przez Reinholda Wohlwenda, Obywatelstwo: Liechtenstein, Adres do korespondencji: 9490, Vaduz, Liechtenstein</li> </ul> <p>e) Audytorem jest: Lucas Tihanyi, członek Liechtenstein Association of Auditors and EXPERTsuisse, Industriering 14, 9491 Ruggell, Liechtenstein</p>																														
2.2	<b>Jakie są kluczowe informacje finansowe dotyczące emitenta?</b>																														
2.2.1	<p>Emitent został założony w dniu 30.11.2023 r. poprzez wpis do rejestru handlowego Księstwa Liechtensteinu. Zgodnie z oświadczeniem Rady Dyrektorów z dnia 25 października 2023 r. Emitent nie podlega zwykłemu audytowi ani przeglądowi audytowemu. Jednakże roczne sprawozdanie finansowe na dzień 31 grudnia 2023 r. oraz śródroczne sprawozdanie finansowe na dzień 15 lipca 2023 r. zostały zbadane przez Audytora.</p> <p>Poniższe kluczowe informacje finansowe zostały sporządzone zgodnie z przepisami Liechtenstein Persons and Companies Law ("PCL"), w szczególności art. 1024 i nast. 1024 i nast.</p> <p style="text-align: center;"><b>Rachunek zysków i strat</b></p> <table border="1" style="margin-left: auto; margin-right: auto;"> <thead> <tr> <th></th> <th style="text-align: center;">31/12/2023</th> <th style="text-align: center;">15/07/2024</th> </tr> </thead> <tbody> <tr> <td><b>Całkowity przychód</b></td> <td style="text-align: center;">0 USD</td> <td style="text-align: center;">0 USD</td> </tr> <tr> <td><b>Zysk/strata z działalności operacyjnej</b></td> <td style="text-align: center;">USD -2'473.03</td> <td style="text-align: center;">USD -30'150.54</td> </tr> <tr> <td><b>Zysk/strata netto</b></td> <td style="text-align: center;">USD -2'473.03</td> <td style="text-align: center;">USD -30'150.54</td> </tr> </tbody> </table> <p style="text-align: center;"><b>Bilans</b></p> <table border="1" style="margin-left: auto; margin-right: auto;"> <thead> <tr> <th></th> <th style="text-align: center;">31/12/2023</th> <th style="text-align: center;">15/07/2024</th> </tr> </thead> <tbody> <tr> <td><b>Aktywa ogółem</b></td> <td style="text-align: center;">50'184,35 USD</td> <td style="text-align: center;">75'244,30 USD</td> </tr> <tr> <td><b>Całkowity kapitał własny</b></td> <td style="text-align: center;">47 526,97 USD</td> <td style="text-align: center;">19'849.46 USD</td> </tr> <tr> <td><b>Zadłużenie finansowe netto (zadłużenie długoterminowe plus zadłużenie krótkoterminowe minus środki pieniężne)</b></td> <td style="text-align: center;">0 USD</td> <td style="text-align: center;">0 USD</td> </tr> </tbody> </table> <p style="text-align: center;"><b>Rachunek przepływów pieniężnych</b></p> <table border="1" style="margin-left: auto; margin-right: auto;"> <thead> <tr> <th></th> <th style="text-align: center;">31/12/2023</th> <th style="text-align: center;">15/07/2024</th> </tr> </thead> <tbody> <tr> <td><b>Przepływy pieniężne netto z działalności operacyjnej</b></td> <td style="text-align: center;">0 USD</td> <td style="text-align: center;">0 USD</td> </tr> </tbody> </table>		31/12/2023	15/07/2024	<b>Całkowity przychód</b>	0 USD	0 USD	<b>Zysk/strata z działalności operacyjnej</b>	USD -2'473.03	USD -30'150.54	<b>Zysk/strata netto</b>	USD -2'473.03	USD -30'150.54		31/12/2023	15/07/2024	<b>Aktywa ogółem</b>	50'184,35 USD	75'244,30 USD	<b>Całkowity kapitał własny</b>	47 526,97 USD	19'849.46 USD	<b>Zadłużenie finansowe netto (zadłużenie długoterminowe plus zadłużenie krótkoterminowe minus środki pieniężne)</b>	0 USD	0 USD		31/12/2023	15/07/2024	<b>Przepływy pieniężne netto z działalności operacyjnej</b>	0 USD	0 USD
	31/12/2023	15/07/2024																													
<b>Całkowity przychód</b>	0 USD	0 USD																													
<b>Zysk/strata z działalności operacyjnej</b>	USD -2'473.03	USD -30'150.54																													
<b>Zysk/strata netto</b>	USD -2'473.03	USD -30'150.54																													
	31/12/2023	15/07/2024																													
<b>Aktywa ogółem</b>	50'184,35 USD	75'244,30 USD																													
<b>Całkowity kapitał własny</b>	47 526,97 USD	19'849.46 USD																													
<b>Zadłużenie finansowe netto (zadłużenie długoterminowe plus zadłużenie krótkoterminowe minus środki pieniężne)</b>	0 USD	0 USD																													
	31/12/2023	15/07/2024																													
<b>Przepływy pieniężne netto z działalności operacyjnej</b>	0 USD	0 USD																													

	<table border="1"> <tr> <td><b>Przepływy pieniężne netto z działalności inwestycyjnej</b></td> <td>0 USD</td> <td>0 USD</td> </tr> <tr> <td><b>Przepływy pieniężne netto z działalności finansowej</b></td> <td>0 USD</td> <td>0 USD</td> </tr> </table> <p>Perspektywy Emitenta nie uległy znaczącemu pogorszeniu od dnia sporządzenia śródrocznego bilansu na dzień 15.07.2024 r. Od dnia sporządzenia śródrocznego bilansu na dzień 15.07.2024 r. nie wystąpiły żadne istotne zmiany w sytuacji finansowej lub handlowej Emitenta.</p>	<b>Przepływy pieniężne netto z działalności inwestycyjnej</b>	0 USD	0 USD	<b>Przepływy pieniężne netto z działalności finansowej</b>	0 USD	0 USD
<b>Przepływy pieniężne netto z działalności inwestycyjnej</b>	0 USD	0 USD					
<b>Przepływy pieniężne netto z działalności finansowej</b>	0 USD	0 USD					
<b>2.3</b>	<b>Jakie są kluczowe ryzyka specyficzne dla emitenta?</b>						
<b>2.3.1</b>	<p><b>Niski kapitał</b> Celem Emitenta jest komercjalizacja technologii AWEARE. Kapitał własny Emitenta jest ograniczony do 50.000,00 USD, przy czym minimalny kapitał wymagany zgodnie z prawem Liechtensteinu wynosi 50.000,00 USD. Ponieważ Emitent został utworzony w dniu 30.11.2023 r., nie są dostępne żadne istotne historyczne dane finansowe ani kluczowe dane liczbowe, inne niż historyczne informacje finansowe, o których mowa w punkcie 2.2.1 niniejszego podsumowania, umożliwiające ocenę sytuacji finansowej Emitenta w odniesieniu do lat ubiegłych. Emitent nie podlega zwyktemu badaniu przez biegłego rewidenta ani przeglądowi przez biegłego rewidenta. Emitent nie był oceniany przez agencję ratingową. Niski kapitał własny stanowi zwiększone ryzyko dla inwestora, ponieważ jego funkcja jako kapitału odpowiedzialnego jest odpowiednio ograniczona.</p> <p><b>Ryzyko niewypłacalności</b> W przypadku wszczęcia postępowania upadłościowego w stosunku do aktywów Emitenta, Emitent będzie czasowo lub trwale ograniczony w rozporządzaniu swoimi aktywami lub rozporządzanie aktywami Emitenta zostanie przejęte przez wyznaczonego przez sąd syndyka masy upadłościowej. Może to mieć negatywny wpływ na sytuację finansową i działalność gospodarczą Emitenta. Przypadek taki może mieć miejsce nawet wówczas, gdy wnioski o ogłoszenie upadłości zostały złożone nieprawidłowo. W przypadku niewypłacalności Emitenta Uczestnicy ponoszą odpowiedzialność za zainwestowany kapitał. Zainwestowany kapitał należy traktować jako kapitał własny i dlatego jest on kwalifikowany podporządkowany.</p> <p><b>Finansowanie działalności</b> Nie ma minimalnego kapitału do pozyskania. Nie ma gwarancji plasowania, ale raczej ryzyko, że globalne tokeny AWEARE nie zostaną w pełni subskrybowane (ryzyko plasowania). Jeśli Emitentowi nie uda się pozyskać pożądanego wolumenu emisji, Emitent będzie mógł zainwestować mniej. Istnieje ryzyko niedoboru kapitału dla Emitenta. Ponadto pozostaną koszty emisji, które są niezależne od wielkości pozyskanego kapitału, co spowoduje wzrost wskaźnika kosztów w stosunku do całości pozyskanego kapitału inwestycyjnego. Istnieje ryzyko, że w takim przypadku Emitent nie osiągnie zamierzonych celów inwestycyjnych i nie będzie w stanie wywiązać się ze swoich zobowiązań wynikających z Globalnych Tokenów AWEARE.</p> <p><b>Zarządzanie, technologia, zależność od zewnętrznych dostawców usług, konkurencja i ramy czasowe rozwoju</b> Jednym z kluczowych atutów Emitenta jest umiejętne wykorzystanie najnowszych technologii radarowych. Jednakże przewaga techniczna w branży technologii informacyjnych i komunikacyjnych może być krótkotrwała. W związku z powyższym, powodzenie emisji będzie częściowo zależało od zdolności Emitenta do zarządzania i rozszerzania zakresu świadczonych usług oraz powiększania bazy użytkowników, a tym samym generowania przychodów w odpowiedzi na zmieniające się technologie, wymagania użytkowników i zewnętrznych dostawców usług oraz presję konkurencyjną. Niepowodzenie lub opóźnienia w tym zakresie mogą mieć negatywny wpływ na sukces Emitenta.</p> <p><b>Błąd ludzki w inteligentnych kontraktach</b> Emitent nie ponosi żadnej odpowiedzialności i nie składa żadnych oświadczeń ani zapewnień co do funkcjonalności projektu Emitenta lub jakichkolwiek inteligentnych kontraktów, które mogą zostać zaprogramowane lub wykorzystane do rozliczenia oferty zgodnie z niniejszym Prospektem w najszerszym tego słowa znaczeniu. W rezultacie inwestorzy mogą ponieść straty lub ogólnie ponieść całkowitą stratę. Jednak w takich scenariuszach mogą mieć zastosowanie mechanizmy prawne chroniące inwestora przed stratą.</p>						
<b>SEKCJA 3 - KLUCZOWE INFORMACJE NA TEMAT PAPIERÓW WARTOŚCIOWYCH</b>							
<b>3.1</b>	<b>Jakie są główne cechy papierów wartościowych?</b>						
<b>3.1.1</b>	<b>Informacje o papierach wartościowych</b>						
<b>a)</b>	<p><b>Opis rodzaju i klasy papierów wartościowych</b></p> <p><b>1.400.000</b> nowych certyfikatów uczestnictwa oferowanych publicznie przez Emitenta to certyfikaty uczestnictwa na okaziciela bez prawa głosu, każdy o wartości nominalnej <b>0,01 USD</b> kapitału zakładowego ("<b>Globalne Tokeny AWEARE</b>"), pochodzące z nowej emisji kapitału zakładowego uchwalonej przez Nadzwyczajne Walne Zgromadzenie w dniu 18/07/2024. Posiadacze Globalnych Tokenów AWEARE nazywani są "<b>Uczestnikami</b>" lub "<b>Posiadaczami Tokenów</b>".</p>						

b)	<b>Waluta emisji papierów wartościowych</b>	Dolar amerykański ("USD" lub "\$"). Okres ważności AWEARE Global Token jest nieograniczony.
c)	<b>Opis praw związanych z papierami wartościowymi</b>	<p><b>Prawo do głosowania</b> Globalne Tokeny AWEARE są certyfikatami uczestnictwa bez prawa głosu i nie uprawniają Uczestnika do głosowania, zwoływania i uczestniczenia w Walnym Zgromadzeniu Emitenta. Ponadto Globalne Tokeny AWEARE nie przyznają prawa do informacji, prawa wglądu ani prawa do złożenia wniosku. Jednakże pisemny wniosek o udzielenie informacji, przeprowadzenie kontroli lub wszczęcie urzędowej kontroli może zostać złożony na Walnym Zgromadzeniu.</p> <p><b>Ogłoszenie o zwołaniu i uchwały Walnego Zgromadzenia</b> Uczestnicy muszą zostać powiadomieni o zwołaniu Walnego Zgromadzenia wraz z podaniem punktów porządku obrad i wniosków. Każda uchwała Walnego Zgromadzenia musi być niezwłocznie udostępniona Uczestnikom do wglądu w siedzibie Emitenta. Uczestnicy zostaną o tym poinformowani w zawiadomieniu.</p> <p><b>Prawo do dywidendy i udział w zyskach z likwidacji</b> Globalne Tokeny AWEARE mają pełne prawo do dywidendy od daty ważnego nabycia i uprawniają ich posiadaczy do udziału w przychodach z likwidacji proporcjonalnie do ich udziału w kapitale zakładowym. Emitent nie planuje obecnie wypłaty dywidendy w najbliższej przyszłości. Emitent nie planuje obecnie wypłaty dywidendy w najbliższej przyszłości. Pomimo istnienia rozszczenia o wypłatę dywidendy wynikającego ze Statutu, nie przewiduje się wypłaty dywidendy w przyszłości. Emitent zamierza reinwestować zyski w dalszy wzrost i rozwój spółki.</p> <p><b>Forma i sekurytyzacja</b> Tokeny AWEARE Global będą emitowane jako tokeny. Tokeny to prawa do wartości, które są emitowane w zdecentralizowanej bazie danych (Blockchain) i tam przenoszone. Blockchain używany do tego celu to Ethereum Blockchain.</p> <p><b>Wyłączenie praw poboru i praw uczestnictwa</b> Do czasu osiągnięcia docelowego kapitału partycypacyjnego w wysokości 50.000 USD, prawa uprzywilejowane zgodnie z art. 304d, 304f i 304g PCL, w szczególności prawa subskrypcji i prawa uczestnictwa Uczestników, są wyłączone.</p> <p><b>Zbywalność papierów wartościowych</b> Przeniesienie (takie jak przeniesienie w wąskim znaczeniu, zastawienie, dziedziczenie) Globalnych Tokenów AWEARE wymaga zgody Zarządu Emitenta. Zbywalność jest zatem ograniczona do pewnego stopnia. W każdym razie przeniesienie globalnych tokenów AWEARE jest niedozwolone, jeśli byłyby one wówczas w posiadaniu osoby w kraju, w którym globalne tokeny AWEARE nie mogą być oferowane. Uznaje się również, że przeniesienie w powyższym znaczeniu ma miejsce, jeśli posiadacz tokena przenosi swoje miejsce zamieszkania do kraju, w którym globalne tokeny AWEARE nie mogą być oferowane.</p>
d)	<b>Względne uprzywilejowanie papierów wartościowych w strukturze kapitałowej emitenta w przypadku niewypłacalności</b>	W przypadku niewypłacalności Emitenta, Uczestnicy odpowiadają swoim zainwestowanym kapitałem. Zainwestowany kapitał należy traktować jako kapitał własny i dlatego jest on kwalifikowanie podporządkowany.
e)	<b>Opis polityki dywidendowej</b>	Dotychczas nie wypłacono żadnej dywidendy. Emitent nie sporządza żadnych prognoz ani szacunków zysków, w związku z czym opis polityki dywidendowej nie jest sporządzany. Ewentualne dywidendy będą wypłacane w USD. Emitent zastrzega sobie prawo do wypłaty dywidendy również w innej walucie lub kryptowalucie. Wszelkie uchwały o wypłacie dywidendy będą podejmowane zgodnie z obowiązującymi przepisami prawa i będą uzależnione m.in. od wyników działalności Emitenta, jego sytuacji finansowej, ograniczeń umownych i wymogów kapitałowych. W każdym przypadku 5% zysku netto będzie przeznaczane na ustawowe kapitały rezerwowe, aż do osiągnięcia kwoty 10% wpłaconego kapitału zakładowego.
<b>3.2</b>	<b>Gdzie papiery wartościowe będą przedmiotem obrotu?</b>	
<b>3.2.1</b>	Globalne Tokeny AWEARE nie są dopuszczone do obrotu na rynku regulowanym. Emitent zastrzega sobie prawo do ubiegania się o dopuszczenie do obrotu na rynku regulowanym.	
<b>3.4</b>	<b>Jakie są kluczowe ryzyka specyficzne dla papierów wartościowych?</b>	
<b>3.4.1</b>	<b>Ryzyko związane z portfelem inwestorów i kluczami prywatnymi</b>	

	<p>Inwestor sam ponosi ryzyko wyboru portfela lub lokalizacji klucza prywatnego. Jeśli używany jest niekompatybilny portfel lub klucz prywatny zostanie utracony, dostęp do globalnych tokenów AWEARE jest zwykle niemożliwy. Konsekwencje, takie jak całkowita utrata inwestycji, muszą być ponoszone wyłącznie przez inwestora.</p> <p><b>Ryzyko zbywalności, płynności i realizacji</b> Nie ma pewności, że rozwinie się płynny rynek dla globalnych tokenów AWEARE. W rezultacie globalne tokeny AWEARE nie mogą być sprzedawane na rynku wtórnym, co stwarza ryzyko płynności dla inwestora.</p> <p><b>Ryzyko zmienności</b> Istnieje ryzyko związane ze zmiennością ceny akcji. Jeśli tokeny AWEARE Global zostaną sprzedane i zostaną złapane w gwałtowne wahania cen w dół, posiadacz tokena może ponieść straty, z których niektóre mogą być znaczne, w wyniku sprzedaży.</p> <p><b>Utrata żetonów</b> Tokeny mogą zostać utracone lub stać się niedostępne, w szczególności jeśli posiadacz tokena utraci odpowiedni klucz prywatny do dysponowania swoimi globalnymi tokenami AWEARE lub z powodu nieprawidłowego działania e-portfela, w którym przechowywane są globalne tokeny AWEARE. Może to spowodować utratę Tokenów. Wyłączną odpowiedzialnością posiadaczy tokenów jest bezpieczne przechowywanie i ochrona klucza prywatnego, który umożliwia dostęp do e-portfela. Tokeny mogą stać się niedostępne również w przypadku śmierci posiadacza Tokena, jeśli nie dokonał on ustaleń dotyczących takich przypadków. Ani Emitent, ani żaden inny organ lub instytucja nie będzie w stanie przywrócić dostępu do portfela Tokenholder dla następców Tokenholder. Utrata kluczy prywatnych może ponadto ograniczyć dostępność różnych funkcjonalności STO i AWEARE Global Tokens. W szczególności może być niemożliwe wydanie globalnych tokenów AWEARE subskrybentom lub uczynienie ich zbywalnymi, w którym to przypadku pozostaną one wstrzymane na czas nieokreślony. Ponadto wypłata dywidendy może być niemożliwa. Wreszcie istnieje ryzyko, że atakujący może wybić globalne tokeny AWEARE dla adresów, które nie wniosły wkładu, zmienić status potwierdzenia, wnieść niekontrolowane kwoty do STO lub umożliwić atakującemu wycofanie nieodebranych wypłat dywidendy.</p> <p><b>Ograniczone prawa posiadaczy Tokenów</b> Globalne Tokeny AWEARE są certyfikatami uczestnictwa bez prawa głosu i nie uprawniają posiadaczy Tokenów do głosowania, zwoływania i uczestniczenia w Walnym Zgromadzeniu Emitenta. Ponadto Globalne Tokeny AWEARE nie dają prawa do informacji, prawa wglądu i prawa do składania wniosków. Walne Zgromadzenie Emitenta może zatem podejmować uchwały, które mogą niekorzystnie wpływać na prawa posiadaczy Tokenów. Posiadacze Tokenów nie mają możliwości kontrolowania wykorzystania wpływów z emisji Globalnych Tokenów AWEARE. Przeniesienie (takie jak przeniesienie w wąskim znaczeniu, zastawienie, dziedziczenie) Globalnych Tokenów AWEARE wymaga zgody Rady Dyrektorów Emitenta. W każdym przypadku przeniesienie globalnych tokenów AWEARE jest niedozwolone, jeśli byłyby one następnie w posiadaniu osoby w kraju, w którym globalne tokeny AWEARE nie mogą być oferowane. Uznaje się również, że przeniesienie w powyższym znaczeniu ma miejsce, jeśli posiadacz tokena przenosi swoje miejsce zamieszkania do kraju, w którym globalne tokeny AWEARE nie mogą być oferowane. Ustawowe prawo subskrypcji posiadaczy tokenów w przypadku podwyższenia kapitału w ramach niniejszej oferty jest wyłączone.</p> <p><b>Roszczenia posiadaczy Tokenów są podporządkowane</b> Prawa posiadaczy Tokenów do roszczeń i otrzymywania wypłat dywidendy od Emitenta są podporządkowane roszczeniom wszystkich posiadaczy niepodporządkowanych zobowiązań Emitenta. W przypadku likwidacji Emitenta, Posiadacze Tokenów otrzymają wypłatę tylko wtedy, gdy wszystkie uprzywilejowane zobowiązania Emitenta zostaną spłacone.</p>
<b>SEKCJA 4 - KLUCZOWE INFORMACJE DOTYCZĄCE PUBLICZNEJ OFERTY PAPIERÓW WARTOŚCIOWYCH</b>	
<b>4.1</b>	<b>Na jakich warunkach i zgodnie z jakim harmonogramem mogę zainwestować w ten papier wartościowy?</b>
<p><b>Kraje, w których oferowane są papiery wartościowe</b> Oferta obejmuje oferty publiczne w Austrii, Belgii, Bułgarii, Chorwacji, na Cyprze, w Czechach, Danii, Estonii, Finlandii, Francji, Niemczech, Grecji, na Węgrzech, w Islandii, Irlandii, Włoszech, na Łotwie, w Liechtensteinie, na Litwie, w Luksemburgu, na Malcie, w Holandii, Norwegii, Polsce, Portugalii, Rumunii, Słowacji, Słowenii, Hiszpanii, Szwecji i Szwajcarii, a także oferty prywatne w niektórych jurysdykcjach poza tymi krajami.</p> <p><b>Kraje, w których papiery wartościowe nie są oferowane</b> Globalne Tokeny AWEARE Emitenta nie są i nie będą rejestrowane zgodnie z przepisami amerykańskiej ustawy o papierach wartościowych z 1933 r., z późniejszymi zmianami, ani w organach regulacyjnych ds. papierów wartościowych jakiegokolwiek stanu Stanów Zjednoczonych Ameryki, Australii, Japonii lub Kanady. W związku z tym nie będą one oferowane, sprzedawane ani dostarczane bezpośrednio lub pośrednio do publicznej wiadomości, chyba że na podstawie zwolnienia z wymogów rejestracyjnych. W szczególności niniejszy Prospekt Emisyjny nie stanowi oferty sprzedaży ani zaproszenia do złożenia oferty zakupu Globalnych Tokenów AWEARE w Stanach Zjednoczonych Ameryki, Australii, Japonii i Kanadzie i nie może być tam dystrybuowany. Ponadto niniejszy Prospekt nie stanowi ani nie stanowi oferty sprzedaży ani zaproszenia do złożenia oferty zakupu Globalnych Tokenów AWEARE w Rosji, Iranie, Korei Północnej, Białorusi, Syrii ani na żadnym z ich terytoriów. I nie może być tam dystrybuowany.</p> <p><b>Licytacja</b> Proces subskrypcji globalnych tokenów AWEARE odbędzie się online na stronie <a href="https://kyc.awearetech.li/">https://kyc.awearetech.li/</a> ("Dashboard").</p>	

**Okres obowiązywania oferty**

Okres, w którym inwestorzy mogą składać oferty zakupu globalnych tokenów AWEARE, rozpoczyna się w dniu zatwierdzenia Prospektu i kończy rok później ("**Okres Oferty**"). W ostatnim dniu Okresu Oferty oferty mogą być składane do godziny 12:00 czasu obowiązującego w Liechtensteinie.

**Cena oferty**

Cena ofertowa jednego tokena AWEARE wynosi **12,00 USD** ("**Cena ofertowa**").

Aby zachęcić do wczesnych inwestycji, dostępne są następujące zniżki:

W przypadku inwestycji w wysokości od 10 000 USDC do 49 999,99 USDC inwestorzy otrzymają rabat w wysokości 10%, dzięki czemu cena za token AWEARE wyniesie 10,80 USD.

W przypadku inwestycji w wysokości 50 000 USDC lub więcej, inwestorzy otrzymają rabat w wysokości 15%, dzięki czemu cena za token AWEARE wyniesie 10,20 USD.

**Dostępność zniżek**

Powyższe zniżki są dostępne **do momentu wystąpienia jednej z poniższych okoliczności, w zależności od tego, która z nich wystąpi wcześniej:**

- **osiągnięcie całkowitego wolumenu inwestycji w wysokości 5 000 000 USDC**, lub
- **po upływie trzech miesięcy od rozpoczęcia oferty.**

**Dostawa i rozliczenie**

Każdy inwestor musi ukończyć proces subskrypcji online na Dashboardzie. Globalne Tokeny AWEARE zostaną przydzielone poza łańcuchem jako zapis w bazie danych Emitenta, który może być widoczny za pośrednictwem Dashboardu, po uiszczeniu Ceny Oferty. Globalne tokeny AWEARE zostaną przydzielone w łańcuchu w inteligentnym kontrakcie najpóźniej w ciągu dwóch miesięcy po zakończeniu okresu oferty. Po zakończeniu całkowitej oferty globalnych tokenów AWEARE (po osiągnięciu docelowego kapitału partycypacyjnego) i podjęciu przez Emitenta decyzji o sfinalizowaniu inteligentnego kontraktu, globalne tokeny AWEARE zostaną dostarczone do portfela kryptograficznego inwestora.

**Rozcieńczenie**

Ponieważ ustawowe prawo subskrypcji wszystkich uczestników jest wyłączone w przypadku podwyższenia kapitału w kontekście tej oferty, uczestnicy tej oferty nie zostaną rozwodnieni.

**Łączne wpływy netto i szacunkowe koszty emisji**

Łączne wpływy netto z oferty ponad 1 400 000 globalnych tokenów AWEARE mogą wynieść około **15 000 000 USD**, co odpowiada realizacji pozyskania środków. Oczekiwane całkowite koszty oferty wynoszą około **1 500 000 USD** i zostaną pobrane z wpływów.

<b>4.2</b>	<b>Dlaczego przygotowywany jest ten prospekt?</b>
<b>4.2.1</b>	<p>a) Szacowane wpływy netto z emisji papierów wartościowych zostaną wykorzystane przede wszystkim na badania i rozwój oraz ochronę własności intelektualnej. W razie potrzeby konieczne może być przesunięcie do 50% przydzielonego budżetu na inną pozycję.</p> <ul style="list-style-type: none"> <li>i) 10% Koszt podwyżki</li> <li>ii) 11% Ogólne i administracyjne</li> <li>iii) 41% Badania i rozwój</li> <li>iv) 17% Prawne (globalna ochrona własności intelektualnej)</li> <li>v) 21% Rozwój biznesu, sprzedaż i marketing</li> </ul> <p>b) Obecni akcjonariuszami AWEARE Technologies Inc. i Global Innovation Partners Limited są Mahesh Reddy i dr Daniel Hyman. Mahesh Reddy i dr Daniel Hyman są również dyrektorami i akcjonariuszami mniejszościowymi Emitenta.</p> <p>c) Equanimity AG otrzymuje opłatę transakcyjną w wysokości 3% wszystkich naliczonych płatności kryptowalutowych i fiat. Marcel Füssinger, który jest jednym z dyrektorów Emitenta, jest również dyrektorem i właścicielem Equanimity AG.</p> <p>d) <b>Łączne wpływy netto i szacunkowe koszty emisji</b> Całkowite wpływy netto z oferty ponad 1 400 000 globalnych tokenów AWEARE mogą wynieść około <b>15 000 000 USD</b>, co odpowiada realizacji pozyskania funduszy. Oczekiwane całkowite koszty oferty wynoszą około <b>1 500 000 USD</b> i zostaną pobrane z wpływów.</p> <p>e) <b>Ustalenia dotyczące gwarantowania emisji</b> Oferta nie jest przedmiotem wiążącej umowy subemisji. Nie istnieje żadna umowa, na mocy której subemitent byłby zobowiązany do gwarantowania niesprzedanych tokenów. W związku z tym nie ma gwarancji, że cała oferta zostanie uplasowana.</p>

## XVIII. RESUMO DO PROSPECTO

O presente resumo contém todos os elementos que devem ser incluídos num resumo para este tipo de valores mobiliários e de emitente.

SECÇÃO 1 - INTRODUÇÃO		
1.1	Nome e ISIN dos títulos	Os <b>1.400.000</b> novos certificados de participação pública são certificados de participação ao portador sem direito de voto da AWEARE Global AG. O nome destes certificados de participação é " <b>AWEARE Global Tokens</b> ". O ISIN é LI1363014385.
1.2	Identidade e dados de contacto do emitente, incluindo o seu identificador de entidade jurídica (LEI)	<b>AWEARE Global AG</b> (o "Emissor") c/o Revalier Aktiengesellschaft Pradafant 11, 9490 Vaduz, Principado de Tel: +423 237 63 47 Correio eletrónico: <a href="mailto:info@awearetech.li">info@awearetech.li</a> O LEI é: 391200PTNEZNXGJW1C39
1.3	Autoridade competente	<b>Autoridade do Mercado Financeiro</b> (a "FMA") Landstrasse 109, 9490 Vaduz, Principado do Liechtenstein Tel: +423 236 73 73 Fax: +423 236 73 74 Correio eletrónico: <a href="mailto:info@fma-li.li">info@fma-li.li</a>
1.4	Data de aprovação do prospeto	05/12/2024
1.5	Avisos	
1.5.1	<p>a) O resumo deve ser lido como uma introdução a este Prospeto. Qualquer decisão de investimento nos valores mobiliários deve basear-se na análise do Prospeto na sua globalidade pelo investidor.</p> <p>b) O investidor pode perder a totalidade ou parte do capital investido.</p> <p>c) Se for apresentada em tribunal uma queixa relacionada com a informação contida no prospeto, o investidor queixoso poderá, ao abrigo da legislação nacional, ter de suportar os custos de tradução do prospeto antes do início do processo judicial.</p> <p>d) A responsabilidade civil só é aplicável às pessoas que tenham apresentado o sumário, incluindo qualquer tradução do mesmo, mas apenas se o sumário for enganador, inexato ou incoerente, quando lido em conjunto com as outras partes do Prospeto, ou se não fornecer, quando lido em conjunto com as outras partes do Prospeto, informações fundamentais para ajudar os investidores a ponderar se devem investir nos valores mobiliários.</p>	
SECÇÃO 2 - INFORMAÇÕES FUNDAMENTAIS SOBRE O EMITENTE		
2.1	Quem é o emitente dos títulos?	
2.1.1	Informações sobre o emitente	
	<p>a) O nome legal e comercial do Emissor é "AWEARE Global AG". O Emissor é uma sociedade anónima constituída no Principado do Liechtenstein e regida pelas leis do Principado do Liechtenstein. O Emissor tem a sua sede social em Vaduz, no Principado do Liechtenstein e está registado no Gabinete de Justiça / Registo Comercial do Principado do Liechtenstein com o número de registo FL-0002.714.015-4.</p> <p>b) O objetivo do Emitente é desenvolver e rentabilizar tecnologias de sensores e inteligência artificial para veículos autónomos e outras aplicações.</p> <p>c) Os principais acionistas do Emitente são:</p> <ul style="list-style-type: none"><li>• Global Innovation Partners Limited, Ilhas Virgens Britânicas, com os acionistas maioritários Dr. Daniel Hyman, Mahesh Reddy, Dr. Reginald Tang e Mark Hyman</li></ul> <p>d) O Conselho de Administração do Emitente é composto por:</p> <ul style="list-style-type: none"><li>• Dr. Daniel Hyman, nacionalidade: Estados Unidos, endereço postal: Long Beach, Califórnia, EUA</li><li>• Mahesh Reddy, nacionalidade: Estados Unidos, Endereço para correspondência: Irvine, Califórnia, EUA</li><li>• Marcel Füssinger, nacionalidade: Áustria, endereço postal: 160009, Singapura</li><li>• Revalier AG, representada por Reinhold Wohlwend, nacionalidade: Liechtenstein, endereço postal: 9490, Vaduz, Liechtenstein</li></ul> <p>e) O auditor é: Lucas Tihanyi, Membro da Associação de Auditores do Liechtenstein e EXPERTsuisse, Industriering 14, 9491 Ruggell, Liechtenstein</p>	



2.2	<b>Quais são as principais informações financeiras relativas ao emitente?</b>																																				
2.2.1	<p>O Emissor foi fundado em 30/11/2023 por inscrição no registo comercial do Principado do Liechtenstein. De acordo com a declaração do Conselho de Administração datada de 25 de outubro de 2023, o Emitente não está sujeito a uma auditoria ordinária e não está sujeito a uma revisão de auditoria. No entanto, as demonstrações financeiras anuais a 31 de dezembro de 2023 e as demonstrações financeiras intercalares a 15 de julho de 2023 foram auditadas pelo Auditor.</p> <p>A informação financeira fundamental que se segue foi preparada de acordo com as disposições da Lei das Pessoas e das Sociedades do Liechtenstein ("PCL"), em particular o Art. 1024 e seguintes.</p> <p style="text-align: center;"><b>Demonstração de resultados</b></p> <table border="1" data-bbox="403 528 1251 779"> <thead> <tr> <th></th> <th>31/12/2023</th> <th>15/07/2024</th> </tr> </thead> <tbody> <tr> <td><b>Receitas totais</b></td> <td>0 USD</td> <td>0 USD</td> </tr> <tr> <td><b>Lucro/perda operacional</b></td> <td>USD -2'473.03</td> <td>USD -30'150.54</td> </tr> <tr> <td><b>Lucro/perda líquida</b></td> <td>USD -2'473.03</td> <td>USD -30'150.54</td> </tr> </tbody> </table> <p style="text-align: center;"><b>Balanco</b></p> <table border="1" data-bbox="403 878 1251 1155"> <thead> <tr> <th></th> <th>31/12/2023</th> <th>15/07/2024</th> </tr> </thead> <tbody> <tr> <td><b>Total do ativo</b></td> <td>50'184.35 USD</td> <td>75'244.30 USD</td> </tr> <tr> <td><b>Total do capital próprio</b></td> <td>USD 47.526,97</td> <td>19'849.46 USD</td> </tr> <tr> <td><b>Dívida financeira líquida (dívida de longo prazo mais dívida de curto prazo menos caixa)</b></td> <td>0 USD</td> <td>0 USD</td> </tr> </tbody> </table> <p style="text-align: center;"><b>Demonstração dos fluxos de caixa</b></p> <table border="1" data-bbox="403 1254 1251 1547"> <thead> <tr> <th></th> <th>31/12/2023</th> <th>15/07/2024</th> </tr> </thead> <tbody> <tr> <td><b>Fluxos de caixa líquidos relevantes das actividades operacionais</b></td> <td>0 USD</td> <td>0 USD</td> </tr> <tr> <td><b>Fluxos de caixa líquidos relevantes das actividades de investimento</b></td> <td>0 USD</td> <td>0 USD</td> </tr> <tr> <td><b>Líquido relevante Fluxos de caixa das actividades de financiamento</b></td> <td>0 USD</td> <td>0 USD</td> </tr> </tbody> </table> <p>As perspetivas do Emitente não se deterioraram significativamente desde a data do balanço intercalar em 15/07/2024. Não se registaram alterações significativas na situação financeira ou na posição comercial do Emitente desde a data de apresentação do balanço intercalar em 15/07/2024.</p>		31/12/2023	15/07/2024	<b>Receitas totais</b>	0 USD	0 USD	<b>Lucro/perda operacional</b>	USD -2'473.03	USD -30'150.54	<b>Lucro/perda líquida</b>	USD -2'473.03	USD -30'150.54		31/12/2023	15/07/2024	<b>Total do ativo</b>	50'184.35 USD	75'244.30 USD	<b>Total do capital próprio</b>	USD 47.526,97	19'849.46 USD	<b>Dívida financeira líquida (dívida de longo prazo mais dívida de curto prazo menos caixa)</b>	0 USD	0 USD		31/12/2023	15/07/2024	<b>Fluxos de caixa líquidos relevantes das actividades operacionais</b>	0 USD	0 USD	<b>Fluxos de caixa líquidos relevantes das actividades de investimento</b>	0 USD	0 USD	<b>Líquido relevante Fluxos de caixa das actividades de financiamento</b>	0 USD	0 USD
	31/12/2023	15/07/2024																																			
<b>Receitas totais</b>	0 USD	0 USD																																			
<b>Lucro/perda operacional</b>	USD -2'473.03	USD -30'150.54																																			
<b>Lucro/perda líquida</b>	USD -2'473.03	USD -30'150.54																																			
	31/12/2023	15/07/2024																																			
<b>Total do ativo</b>	50'184.35 USD	75'244.30 USD																																			
<b>Total do capital próprio</b>	USD 47.526,97	19'849.46 USD																																			
<b>Dívida financeira líquida (dívida de longo prazo mais dívida de curto prazo menos caixa)</b>	0 USD	0 USD																																			
	31/12/2023	15/07/2024																																			
<b>Fluxos de caixa líquidos relevantes das actividades operacionais</b>	0 USD	0 USD																																			
<b>Fluxos de caixa líquidos relevantes das actividades de investimento</b>	0 USD	0 USD																																			
<b>Líquido relevante Fluxos de caixa das actividades de financiamento</b>	0 USD	0 USD																																			
2.3	<b>Quais são os principais riscos específicos do emitente?</b>																																				
2.3.1	<p><b>Capital reduzido</b> O objetivo do Emissor é a comercialização da tecnologia da AWEARE. O capital social da Emissora é limitado a USD 50.000,00, sendo que o capital mínimo exigido pela legislação do Liechtenstein é de USD 50.000,00. Dado que o Emissor foi constituído em 30/11/2023, não existem dados financeiros históricos significativos ou números-chave, para além da informação financeira histórica referida na secção 2.2.1 do presente resumo, para avaliar a situação financeira do Emissor em relação aos últimos anos. O Emitente não está sujeito a uma auditoria ordinária e não tem uma revisão de auditoria. O Emitente não foi avaliado por uma agência de notação. Um capital próprio reduzido representa um risco acrescido para o investidor, uma vez que a função de capital de garantia é correspondentemente reduzida.</p> <p><b>Risco de insolvência</b> Em caso de abertura de um processo de insolvência sobre os activos do Emitente, este ficará temporária ou permanentemente limitado na alienação dos seus activos, ou a alienação dos activos do Emitente será assumida</p>																																				

	<p>por um administrador de insolvência nomeado pelo tribunal. Esta situação pode ter um impacto negativo na situação financeira e nas actividades comerciais do Emitente. Este caso pode ocorrer mesmo que os pedidos de insolvência tenham sido apresentados incorretamente. Em caso de insolvência do Emitente, os Participantes são responsáveis pelo capital investido. O capital investido deve ser tratado como capital próprio e está, por conseguinte, qualificado como subordinado.</p> <p><b>Financiamento das empresas</b></p> <p>Não há capital mínimo a ser levantado. Não há garantia de colocação, mas sim o risco de que os AWEARE Global Tokens não sejam totalmente subscritos (risco de colocação). Se o Emissor não conseguir solicitar o volume de emissão desejado, o Emissor poderá investir menos. Existe o risco de um défice de capital para o Emissor. Além disso, os custos de emissão, que são independentes do montante de capital angariado, manter-se-ão, o que aumentará o rácio de despesas em relação ao capital de investimento total angariado. Existe o risco de, neste caso, o Emissor não atingir os objectivos de investimento pretendidos e não conseguir cumprir as suas obrigações ao abrigo dos AWEARE Global Tokens.</p> <p><b>Gestão, tecnologia, dependência de fornecedores de serviços terceiros, concorrência e prazos de desenvolvimento</b></p> <p>Um dos principais pontos fortes do Emitente é a sua utilização astuta da mais recente tecnologia de radar. No entanto, as vantagens técnicas no sector das tecnologias da informação e da comunicação podem ser de curta duração. Assim, o sucesso da emissão dependerá, em parte, da sua capacidade para gerir e expandir os serviços do Emissor e aumentar a base de utilizadores da sua atividade e, por conseguinte, gerar receitas em resposta à evolução das tecnologias, às exigências dos utilizadores e dos prestadores de serviços terceiros e às pressões da concorrência. O insucesso ou os atrasos neste domínio podem ter um impacto negativo no sucesso da Emissora.</p> <p><b>Erro humano com contratos inteligentes</b></p> <p>O Emitente não assume qualquer responsabilidade e não faz declarações ou garantias quanto à funcionalidade do projeto do Emitente ou de quaisquer contratos inteligentes que possam ser programados ou utilizados para a liquidação da oferta, em conformidade com o presente Prospeto no sentido mais lato. Os investidores podem sofrer prejuízos em resultado disso ou, em geral, enfrentar uma perda total. No entanto, em tais cenários, podem aplicar-se mecanismos legais para proteger um investidor de perdas.</p>
<b>SECÇÃO 3 - PRINCIPAIS INFORMAÇÕES SOBRE OS VALORES MOBILIÁRIOS</b>	
3.1	Quais são as principais características dos títulos?
3.1.1	Informações sobre os títulos
a)	<p><b>Descrição do tipo e categoria dos valores mobiliários</b></p> <p>Os <b>1.400.000</b> novos certificados de participação oferecidos publicamente pelo Emissor são certificados de participação ao portador sem direito a voto, cada um com um valor nominal de <b>USD0,01</b> do capital de participação (os "<b>AWEARE Global Tokens</b>"), provenientes de uma nova emissão de capital de participação resolvida por uma Assembleia Geral extraordinária em 18/07/2024. Os detentores de AWEARE Global Tokens são chamados de "<b>Participantes</b>" ou "<b>Tokenholders</b>".</p>
b)	<p><b>Moeda da emissão de títulos</b></p> <p>Dólar dos Estados Unidos ("<b>USD</b>" ou "<b>\$</b>"). O prazo de validade do AWEARE Global Token é ilimitado.</p>
c)	<p><b>Descrição dos direitos inerentes aos valores mobiliários</b></p> <p><b>Direito de voto</b> Os AWEARE Global Tokens são certificados de participação sem direito a voto e não dão direito ao Participante de votar, convocar e participar na Assembleia Geral do Emissor. Além disso, os AWEARE Global Tokens não concedem o direito à informação, o direito de inspeção e o direito de apresentar um pedido. No entanto, um pedido escrito de informação ou inspeção ou para o início de uma auditoria oficial pode ser apresentado à Assembleia Geral.</p> <p><b>Anúncio da convocação e deliberações da Assembleia Geral</b> Os Participantes devem ser notificados da convocação da Assembleia Geral, juntamente com os pontos da ordem de trabalhos e as moções. Todas as deliberações da Assembleia Geral devem ser disponibilizadas sem demora para consulta pelos Participantes na sede social do Emitente. Os Participantes serão informados deste facto na convocatória.</p> <p><b>Direito a dividendos e parte do produto da liquidação</b> Os AWEARE Global Tokens têm direito a dividendos totais a partir da data de aquisição válida e dão direito a uma parte do produto da liquidação proporcional à sua participação no capital de participação. Embora exista um direito a dividendos nos termos dos Estatutos, não são feitas previsões relativamente a futuras distribuições de dividendos. O Emissor tenciona reinvestir os lucros no crescimento e desenvolvimento da empresa.</p> <p><b>Forma e titularização</b></p>

		<p>Os AWEARE Global Tokens serão emitidos como tokens. Os tokens são direitos de valor que são emitidos numa base de dados descentralizada (Blockchain) e transferidos para lá. A cadeia de blocos utilizada para este efeito é a cadeia de blocos Ethereum.</p> <p><b>Exclusão dos direitos de subscrição e dos direitos de participação</b> Até ser atingido o objetivo de participação de 50 000 USD, os direitos preferenciais previstos nos artigos 304º-D, 304º-F e 304º-G da LPC, nomeadamente os direitos de subscrição e os direitos de participação dos Participantes, são excluídos.</p> <p><b>Transferibilidade dos títulos</b> A transferência (tal como a transferência no sentido estrito, penhor, herança) de AWEARE Global Tokens requer a aprovação do Conselho de Administração do Emissor. A transferibilidade é, portanto, limitada até certo ponto. Em qualquer caso, uma transferência de AWEARE Global Tokens não é permitida se eles forem mantidos por uma pessoa num país em que os AWEARE Global Tokens não podem ser oferecidos. Considera-se também que ocorre uma transferência no sentido acima referido se um detentor de tokens mudar o seu local de residência para um país no qual os AWEARE Global Tokens não podem ser oferecidos.</p>
d)	<b>Antiguidade relativa dos títulos na estrutura de capital do emitente em caso de insolvência</b>	Em caso de insolvência do Emitente, os Participantes são responsáveis pelo capital investido. O capital investido deve ser tratado como capital próprio, sendo, por conseguinte, qualificado como subordinado.
e)	<b>Descrição da política de dividendos</b>	Até à data, não foram pagos quaisquer dividendos. O Emitente não efectua quaisquer previsões ou estimativas de lucros, pelo que não é feita uma descrição da política de dividendos. Os dividendos, caso existam, serão pagos em USD. O Emitente reserva-se o direito de pagar dividendos também noutra moeda ou criptomoeda. Qualquer decisão de pagamento de dividendos será tomada de acordo com a legislação aplicável e dependerá, entre outros factores, dos resultados operacionais, da situação financeira, das restrições contratuais e das necessidades de capital do Emitente. Em qualquer caso, 5% do lucro líquido será afetado às reservas estatutárias até que estas atinjam o montante de 10% do capital social realizado.
<b>3.2</b>	<b>Onde serão transaccionados os títulos?</b>	
<b>3.2.1</b>	Os AWEARE Global Tokens não estão admitidos à negociação num mercado regulamentado. O Emissor reserva-se o direito de solicitar a admissão à negociação num mercado regulamentado.	
<b>3.4</b>	<b>Quais são os principais riscos específicos dos títulos?</b>	
<b>3.4.1</b>	<p><b>Risco da carteira de investidores e da chave privada</b> O investidor é o único que assume o risco da seleção da carteira ou da localização da chave privada. Se for utilizada uma carteira incompatível ou se a chave privada for perdida, o acesso aos AWEARE Global Tokens é normalmente impossível. As consequências, como a perda total do investimento, devem ser suportadas exclusivamente pelo investidor.</p> <p><b>Risco de alienabilidade, liquidez e risco de realização</b> Não há certeza de que um mercado líquido se desenvolverá para os AWEARE Global Tokens. Como resultado, os AWEARE Global Tokens não poderiam ser vendidos num mercado secundário, criando um risco de liquidez para o investidor.</p> <p><b>Risco de volatilidade</b> Existem riscos relacionados com a volatilidade do preço das acções. Se os AWEARE Global Tokens fossem vendidos e fossem apanhados numa forte flutuação de preços, o detentor do Token poderia sofrer perdas, algumas das quais poderiam ser substanciais, como resultado da venda.</p> <p><b>Perda de fichas</b> Os Tokens podem ser perdidos ou ficar inacessíveis, em particular se o detentor do Token perder a respectiva chave privada para dispor dos seus AWEARE Global Tokens ou devido a um mau funcionamento da carteira eletrónica em que os AWEARE Global Tokens estão armazenados. Isto pode resultar na perda de Tokens. É da exclusiva responsabilidade dos titulares de tokens armazenar e proteger com segurança a chave privada que permite o acesso à carteira eletrónica. Os Tokens podem tornar-se inacessíveis também em caso de morte de um Tokenholder, se este não tiver tomado medidas para esse efeito. Nem o Emitente nem qualquer outro organismo ou instituição poderão restabelecer o acesso à carteira eletrónica do detentor do Token Cartão para os sucessores do detentor do Token Cartão. A perda de chaves privadas pode, além disso, reduzir a disponibilidade de várias funcionalidades da OST e dos AWEARE Global Tokens. Em particular, pode ser impossível emitir AWEARE Global Tokens para os subscritores ou torná-los transferíveis, caso em que permaneceriam em pausa indefinidamente. Além disso, pode ser impossível efetuar pagamentos de dividendos. Finalmente, existe o risco de um atacante poder cunhar AWEARE Global Tokens para endereços que não contribuam, alterar o estado de confirmação,</p>	

	<p>contribuir com montantes não controlados para a OST ou permitir que o atacante retire pagamentos de dividendos não reclamados.</p> <p><b>Direitos limitados dos detentores de tokens</b> Os Tokens Globais AWEARE são certificados de participação sem direito a voto e não dão direito aos detentores de tokens de votar, convocar e participar na Assembleia Geral do Emissor. Além disso, os Tokens Globais AWEARE não concedem o direito à informação, o direito de inspeção e o direito de apresentar um pedido. A Assembleia Geral do Emissor pode, por conseguinte, adotar resoluções que podem afetar negativamente os direitos dos detentores de tokens. Os detentores de tokens não têm a possibilidade de controlar a utilização das receitas da emissão de AWEARE Global Tokens. A transferência (como a transferência no sentido estrito, penhor, herança) dos Tokens Globais AWEARE requer a aprovação do Conselho de Administração do Emissor. Em qualquer caso, uma transferência de AWEARE Global Tokens não é permitida se eles forem mantidos por uma pessoa num país onde os AWEARE Global Tokens não podem ser oferecidos. Uma transferência no sentido acima também é considerada como ocorrendo se um detentor de token mudar seu local de residência para um país no qual os tokens globais da AWEARE não podem ser oferecidos. O direito estatutário de subscrição dos detentores de tokens no caso de um aumento de capital no âmbito desta oferta está excluído.</p> <p>Os direitos dos Tokenholders a reclamar e receber pagamentos de dividendos do Emissor são <b>subordinados</b> aos direitos de todos os detentores de obrigações não subordinadas do Emissor. Numa liquidação do Emitente, os Tokenholders só serão pagos se e depois de todas as obrigações sénior do Emitente terem sido liquidadas.</p>
<b>SECÇÃO 4 - INFORMAÇÃO FUNDAMENTAL SOBRE A OFERTA DE VALORES MOBILIÁRIOS AO PÚBLICO</b>	
4.1	<b>Em que condições e prazos posso investir neste título?</b>
<p><b>Países em que os títulos são oferecidos</b> A oferta consiste em ofertas públicas na Áustria, Bélgica, Bulgária, Croácia, Chipre, República Checa, Dinamarca, Estónia, Finlândia, França, Alemanha, Grécia, Hungria, Islândia, Irlanda, Itália, Letónia, Liechtenstein, Lituânia, Luxemburgo, Malta, Países Baixos, Noruega, Polónia, Portugal, Roménia, Eslováquia, Eslovénia, Espanha, Suécia e Suíça, bem como em colocações privadas em certas jurisdições fora destas.</p> <p><b>Países em que os valores mobiliários não são oferecidos</b> Os AWEARE Global Tokens do Emissor não estão e não serão registados ao abrigo das disposições do United States Securities Act de 1933, conforme alterado, ou com as autoridades reguladoras de títulos de qualquer estado dos Estados Unidos da América, ou na Austrália, Japão ou Canadá. Por conseguinte, não serão oferecidas, vendidas ou entregues direta ou indiretamente ao público, exceto nos termos de uma isenção dos requisitos de registo. Em particular, este Prospeto não constitui ou constitui uma oferta de venda ou a solicitação de uma oferta de compra de Tokens Globais AWEARE nos Estados Unidos da América, Austrália, Japão e Canadá e não pode ser distribuído nesses países. Além disso, este Prospeto não constitui ou constitui uma oferta de venda ou a solicitação de uma oferta de compra de AWEARE Global Tokens na Rússia, Irão, Coreia do Norte, Bielorrússia, Síria ou quaisquer territórios dos mesmos. E não pode ser distribuído nesses territórios.</p> <p><b>Licitação</b> O processo de subscrição dos AWEARE Global Tokens terá lugar online em <a href="https://kyc.awearetech.li/">https://kyc.awearetech.li/</a> (o "Dashboard").</p> <p><b>Período da oferta</b> O período durante o qual os investidores podem submeter as suas ofertas de compra de AWEARE Global Tokens deverá começar na data de aprovação do Prospeto e terminar um ano depois (o "<b>Período de Oferta</b>"). No último dia do Período de Oferta, as ofertas podem ser efectuadas até às 12:00 horas, hora do Liechtenstein.</p> <p><b>Preço da proposta</b> O preço de oferta de um Token AWEARE é de <b>USD 12,00</b> (o "<b>Preço de Oferta</b>").</p> <p>Para incentivar o investimento antecipado, estão disponíveis os seguintes descontos:</p> <p>Para investimentos entre 10.000 USDC e 49.999,99 USDC, os investidores receberão um desconto de 10%, fazendo com que o preço por Token AWEARE seja de 10,80 USD.</p> <p>Para investimentos de 50.000 USDC ou mais, os investidores receberão um desconto de 15%, fazendo com que o preço por token AWEARE seja de 10,20 USD.</p> <p><b>Disponibilidade dos descontos</b> Os descontos acima referidos estão disponíveis <b>até que ocorra uma das seguintes situações, consoante o que ocorrer primeiro</b>:</p> <ul style="list-style-type: none"> <li>• <b>atingir um volume de investimento total de 5 000 000 USDC, ou</b></li> <li>• <b>prazo de três meses a contar do início da oferta.</b></li> </ul> <p><b>Entrega e liquidação</b> Cada investidor deve completar o processo de subscrição online no Dashboard. Os AWEARE Global Tokens serão alocados off-chain como um registo na base de dados do Emissor, que pode ser visível através do Dashboard, contra o pagamento do Preço de Oferta. Os Tokens Globais AWEARE serão alocados on-chain no Contrato Inteligente, o mais tardar dentro de dois</p>	

meses após o final do Período de Oferta. Uma vez que a oferta total de AWEARE Global Tokens (após atingir o capital de participação alvo) tenha terminado e o Emissor tenha decidido finalizar o Contrato Inteligente, os AWEARE Global Tokens serão entregues à carteira criptográfica do investidor.

#### Diluição

Uma vez que o direito legal de subscrição de todos os Participantes está excluído em caso de aumento de capital no contexto desta oferta, os Participantes desta oferta não serão diluídos.

#### Total das receitas líquidas e custos estimados de emissão

O total das receitas líquidas da oferta de mais de 1.400.000 AWEARE Global Tokens pode ascender a cerca de **15.000.000 dólares americanos**, correspondentes à implementação da angariação de fundos. Os custos totais esperados da oferta são de aproximadamente **USD 1.500.000** e serão cobrados a partir das receitas.

<b>4.2</b>	<b>Porque é que este prospeto está a ser elaborado?</b>
<b>4.2.1</b>	<p>a) As receitas líquidas estimadas da emissão dos títulos serão utilizadas principalmente para a investigação e desenvolvimento e para a proteção da propriedade intelectual. Poderá ser necessário transferir até 50% de um orçamento afetado para outra posição, se necessário.</p> <ul style="list-style-type: none"> <li>i) 10% Custo do aumento</li> <li>ii) 11% Geral e administrativo</li> <li>iii) 41% Investigação e desenvolvimento</li> <li>iv) 17% Jurídico (proteção global da PI)</li> <li>v) 21% Desenvolvimento de negócios, vendas e marketing</li> </ul> <p>b) Os actuais acionistas da AWEARE Technologies Inc. e da Global Innovation Partners Limited incluem Mahesh Reddy e o Dr. Daniel Hyman. Mahesh Reddy e o Dr. Daniel Hyman são também diretores e acionistas minoritários do Emissor.</p> <p>c) A Equanimity AG recebe uma taxa de transação de 3% do total de moedas criptográficas e pagamentos fiduciários acumulados. Marcel Füssinger, que é um dos diretores do Emissor, é também o diretor e proprietário da Equanimity AG.</p> <p>d) <b>Total das receitas líquidas e custos estimados de emissão</b> O total das receitas líquidas da oferta de mais de 1.400.000 AWEARE Global Tokens pode ascender a cerca de <b>15.000.000 dólares americanos</b>, correspondentes à implementação da angariação de fundos. Os custos totais esperados da oferta são de aproximadamente <b>USD 1.500.000</b> e serão cobrados a partir dos recursos.</p> <p>e) <b>Acordos de subscrição</b> A oferta não está sujeita a um acordo de subscrição firme. Não existe qualquer acordo nos termos do qual um subscritor seja obrigado a subscrever tokens não vendidos. Por conseguinte, não existe qualquer garantia de que a totalidade da oferta será colocada.</p>

## XIX. REZUMATUL PROSPECTULUI

Acest rezumat conține toate elementele necesare pentru a fi incluse într-un rezumat pentru acest tip de valori mobiliare și emitent.

SECȚIUNEA 1 - INTRODUCERE		
<b>1.1</b>	<b>Denumirea și ISIN ale valorilor mobiliare</b>	Cele <b>1 400 000</b> de noi certificate de participare emise public sunt certificate de participare la purtător fără drept de vot ale AWEARE Global AG. Denumirea acestor certificate de participare este " <b>AWEARE Global Tokens</b> ". ISIN este LI1363014385.
<b>1.2</b>	<b>Identitatea și datele de contact ale emitentului, inclusiv identificatorul entității sale juridice (LEI)</b>	<b>AWEARE Global AG ("Emitentul")</b> c/o Revalier Aktiengesellschaft Pradafant 11, 9490 Vaduz, Principatul Tel: +423 237 63 47 E-mail: info@awearetech.li LEI este: 391200PTNEZNXGJW1C39
<b>1.3</b>	<b>Autoritatea competentă</b>	<b>Autoritatea pieței financiare ("FMA")</b> Landstrasse 109, 9490 Vaduz, Principatul Liechtenstein Tel: +423 236 73 73

		Fax: +423 236 73 74 E-mail: <a href="mailto:info@fma-li.li">info@fma-li.li</a>												
1.4	<b>Data aprobării prospectului</b>	05/12/2024												
1.5	<b>Avertismente</b>													
1.5.1	<p>a) Rezumatul trebuie citit ca o introducere la prezentul Prospect. Orice decizie de a investi în valorile mobiliare trebuie să se bazeze pe examinarea Prospectului în ansamblu de către investitor.</p> <p>b) Investitorul ar putea pierde tot sau o parte din capitalul investit.</p> <p>c) În cazul în care o cerere referitoare la informațiile conținute în prospect este înaintată unei instanțe, investitorul reclamant ar putea, în conformitate cu legislația națională, să fie nevoit să suporte costurile de traducere a prospectului înainte de inițierea procedurilor judiciare.</p> <p>d) Răspunderea civilă se aplică numai persoanelor care au prezentat rezumatul, inclusiv orice traducere a acestuia, dar numai în cazul în care rezumatul este înșelător, inexact sau inconsecvent, atunci când este citit împreună cu celelalte părți ale prospectului sau nu furnizează, atunci când este citit împreună cu celelalte părți ale prospectului, informații esențiale pentru a ajuta investitorii să decidă dacă să investească în valorile mobiliare.</p>													
<b>SECȚIUNEA 2 - INFORMAȚII CHEIE PRIVIND EMITENTUL</b>														
2.1	<b>Cine este emitentul valorilor mobiliare?</b>													
2.1.1	<b>Informații despre emitent</b>													
	<p>a) Denumirea juridică și comercială a emitentului este "AWEARE Global AG". Emitentul este o societate pe acțiuni constituită în Principatul Liechtenstein și guvernată de legile Principatului Liechtenstein. Emitentul are sediul social în Vaduz, Principatul Liechtenstein și este înregistrat la Oficiul de Justiție / Registrul Comerțului din Principatul Liechtenstein sub numărul de înregistrare FL-0002.714.015-4.</p> <p>b) Scopul emitentului este de a dezvolta și de a valorifica tehnologiile senzoriale și inteligența artificială pentru vehicule autonome și alte aplicații.</p> <p>c) Principalii acționari ai emitentului sunt:</p> <ul style="list-style-type: none"> <li>• Global Innovation Partners Limited, Insulele Virgine Britanice, cu acționari majoritari Dr. Daniel Hyman, Mahesh Reddy, Dr. Reginald Tang și Mark Hyman</li> </ul> <p>d) Consiliul de administrație al emitentului este format din:</p> <ul style="list-style-type: none"> <li>• Dr. Daniel Hyman, Naționalitate: Statele Unite, Adresa poștală: Long Beach, California, SUA</li> <li>• Mahesh Reddy, Naționalitate: Statele Unite, Adresa poștală: Irvine, California, SUA</li> <li>• Marcel Füssinger, Naționalitate: Austria, Adresa poștală: 160009, Singapore</li> <li>• Revalier AG reprezentată de Reinhold Wohlwend, naționalitate: Liechtenstein: Liechtenstein, adresa poștală: 9490, Vadwend: 9490, Vaduz, Liechtenstein</li> </ul> <p>e) Auditorul este: Lucas Tihanyi, membru al Asociației Auditorilor din Liechtenstein și EXPERTsuisse, Industriering 14, 9491 Ruggell, Liechtenstein</p>													
2.2	<b>Care sunt principalele informații financiare referitoare la emitent?</b>													
2.2.1	<p>Emitentul a fost înființat la 30.11.2023 prin înscrierea în registrul comerțului din Principatul Liechtenstein. În conformitate cu declarația Consiliului de administrație din data de 25 octombrie 2023, Emitentul nu face obiectul unui audit obișnuit și nu face obiectul unei revizuiri de audit. Cu toate acestea, situațiile financiare anuale la 31 decembrie 2023 și situațiile financiare interimare la 15 iulie 2023 au fost auditate de auditor.</p> <p>Următoarele informații financiare esențiale au fost întocmite în conformitate cu dispozițiile Legii din Liechtenstein privind persoanele și societățile ("PCL"), în special articolul 1024 și următoarele. 1024 et seq.</p> <p style="text-align: center;"><b>Situația veniturilor</b></p> <table border="1" style="margin-left: auto; margin-right: auto;"> <thead> <tr> <th></th> <th style="text-align: center;">31/12/2023</th> <th style="text-align: center;">15/07/2024</th> </tr> </thead> <tbody> <tr> <td><b>Venituri totale</b></td> <td style="text-align: center;">USD 0</td> <td style="text-align: center;">USD 0</td> </tr> <tr> <td><b>Profit/pierdere din exploatare</b></td> <td style="text-align: center;">USD -2'473.03</td> <td style="text-align: center;">USD -30'150.54</td> </tr> <tr> <td><b>Profit net/pierdere netă</b></td> <td style="text-align: center;">USD -2'473.03</td> <td style="text-align: center;">USD -30'150.54</td> </tr> </tbody> </table> <p style="text-align: center;"><b>Bilanț</b></p>			31/12/2023	15/07/2024	<b>Venituri totale</b>	USD 0	USD 0	<b>Profit/pierdere din exploatare</b>	USD -2'473.03	USD -30'150.54	<b>Profit net/pierdere netă</b>	USD -2'473.03	USD -30'150.54
	31/12/2023	15/07/2024												
<b>Venituri totale</b>	USD 0	USD 0												
<b>Profit/pierdere din exploatare</b>	USD -2'473.03	USD -30'150.54												
<b>Profit net/pierdere netă</b>	USD -2'473.03	USD -30'150.54												

	31/12/2023	15/07/2024
<b>Total active</b>	50'184.35 USD	75'244.30 USD
<b>Total capitaluri proprii</b>	47,526.97 USD	USD 19'849.46
<b>Datorie financiară netă (datorie pe termen lung plus datorie pe termen scurt minus numerar)</b>	USD 0	USD 0

#### Situația fluxurilor de numerar

	31/12/2023	15/07/2024
<b>Fluxuri de numerar nete relevante din activități de exploatare</b>	USD 0	USD 0
<b>Relevant net Fluxuri de numerar din activități de investiții</b>	USD 0	USD 0
<b>Relevant net Fluxuri de numerar din activități de finanțare</b>	USD 0	USD 0

Perspectivile emitentului nu s-au deteriorat semnificativ de la data bilanțului intermediar la 15/07/2024. Nu au avut loc modificări semnificative ale poziției financiare sau ale poziției comerciale a emitentului de la data raportării bilanțului intermediar la 15/07/2024.

### 2.3 Care sunt principalele riscuri specifice emitentului?

**2.3.1 Capital redus**  
Scopul emitentului este comercializarea tehnologiei AWEARE. Capitalul propriu al emitentului este limitat la 50 000,00 USD, capitalul minim prevăzut de legislația din Liechtenstein fiind de 50 000,00 USD. Întrucât Emitentul a fost constituit la 30.11.2023, nu sunt disponibile date financiare istorice semnificative sau cifre-cheie, altele decât informațiile financiare istorice menționate la secțiunea 2.2.1 din prezentul rezumat, pentru a evalua situația financiară a Emitentului în raport cu ultimii ani. Emitentul nu face obiectul unui audit obișnuit și nu face obiectul unei revizuirii de audit. Emitentul nu a fost evaluat de o agenție de rating. Capitalurile proprii reduse reprezintă un risc crescut pentru investitor, deoarece funcția de capital de răspundere este redusă în mod corespunzător.

**Riscul de insolvabilitate**  
În cazul deschiderii procedurii de insolvență cu privire la activele Emitentului, Emitentul va fi limitat temporar sau permanent în ceea ce privește înstrăinarea activelor sale, sau înstrăinarea activelor Emitentului va fi preluată de un administrator judiciar desemnat în vederea insolvenței. Acest lucru poate avea un impact negativ asupra poziției financiare și a activităților comerciale ale Emitentului. Acest caz poate apărea chiar dacă cererile de insolvență au fost depuse incorect. În caz de insolvență a emitentului, participanții răspund cu capitalul lor investit. Capitalul investit trebuie tratat ca capital propriu și, prin urmare, este subordonat în mod calificat.

**Finanțarea întreprinderilor**  
Nu există un capital minim care să fie strâns. Nu există nicio garanție de plasament, ci mai degrabă riscul ca AWEARE Global Tokens să nu fie subscrise integral (riscul de plasament). Dacă Emitentul nu reușește să solicite volumul de emisiune dorit, Emitentul va putea investi mai puțin. Există riscul unui deficit de capital pentru emitent. În plus, costurile de emisie, care sunt independente de valoarea capitalului mobilizat, vor rămâne, ceea ce va crește rata cheltuielilor în raport cu capitalul total de investiții mobilizat. Există riscul ca, în acest caz, emitentul să nu își atingă obiectivele de investiții prevăzute și să nu își poată îndeplini obligațiile în temeiul AWEARE Global Tokens.

**Management, tehnologie, dependența de furnizori de servicii terți, concurență și termene de dezvoltare**  
Unul dintre principalele puncte forte ale emitentului este utilizarea inteligentă a celor mai recente tehnologii radar. Cu toate acestea, avantajele tehnice din industria tehnologiei informației și comunicațiilor pot fi de scurtă durată. În consecință, succesul emisiunii va depinde, în parte, de capacitatea sa de a gestiona și extinde serviciile emitentului și de a crește baza de utilizatori a activității sale și, prin urmare, de a genera venituri ca răspuns la tehnologiile în schimbare, la cererile utilizatorilor și ale furnizorilor de servicii terți și la presiunile concurenței. Eșecul sau întârzierile în acest sens pot avea un impact negativ asupra succesului emitentului.

**Eroarea umană cu contractele inteligente**  
Emitentul nu își asumă nicio răspundere și nu face nicio declarație sau garanție cu privire la funcționalitatea proiectului emitentului sau a oricărui contracte inteligente care pot fi programate sau utilizate pentru decontarea ofertei în conformitate cu prezentul prospect în sensul cel mai larg. Investitorii pot suferi în consecință deprecieri sau, în general, se pot confrunta cu o pierdere totală. Cu toate acestea, în astfel de scenarii, se pot aplica mecanisme juridice pentru a proteja un investitor de pierderi.

SECȚIUNEA 3 - INFORMAȚII ESENȚIALE PRIVIND VALORILE MOBILIARE		
3.1	Care sunt principalele caracteristici ale valorilor mobiliare?	
3.1.1	Informații privind valorile mobiliare	
a)	Descrierea tipului și clasei de valori mobiliare	Cele <b>1 400 000</b> de noi certificate de participare oferite public de emitent sunt certificate de participare la purtător fără drept de vot, fiecare cu o valoare nominală de <b>0,01 USD</b> din capitalul de participare (" <b>AWEARE Global Tokens</b> ")., dintr-o nouă emisiune de capital de participare decisă de o adunare generală extraordinară la 18/07/2024. Deținătorii de AWEARE Global Tokens sunt denumiți " <b>participanți</b> " sau " <b>deținători de tokenuri</b> ".
b)	Moneda de emisiune a valorilor mobiliare	Dolarul Statelor Unite (" <b>USD</b> " sau " <b>\$</b> "). Termenul de valabilitate al AWEARE Global Token este nelimitat.
c)	Descrierea drepturilor aferente valorilor mobiliare	<p><b>Dreptul la vot</b> AWEARE Global Tokens sunt certificate de participare fără drept de vot și nu conferă participantului dreptul de a vota, de a convoca și de a participa la adunarea generală a emitentului. În plus, AWEARE Global Tokens nu acordă dreptul la informare, dreptul de inspecție și dreptul de a depune o cerere. Cu toate acestea, o cerere scrisă de informare sau de inspecție sau de inițiere a unui audit oficial poate fi depusă la adunarea generală.</p> <p><b>Anunț de convocare și rezoluții ale adunării generale</b> Participanții trebuie să fie notificați cu privire la convocarea adunării generale, precum și cu privire la punctele de pe ordinea de zi și la moțiuni. Fiecare hotărâre a adunării generale trebuie să fie pusă fără întârziere la dispoziția participanților la sediul social al emitentului pentru a fi consultată. Participanții sunt informați în acest sens în convocare.</p> <p><b>Dreptul la dividende și partea din veniturile din lichidare</b> AWEARE Global Tokens conferă drepturi depline la dividende de la data achiziției valabile și dau dreptul deținătorilor lor la o parte din veniturile din lichidare proporțional cu participarea lor la capitalul de participare. Emitentul nu intenționează în prezent să distribuie dividende în viitorul apropiat. Deși există un drept la dividende în temeiul statutului, nu se fac previziuni cu privire la distribuțiile viitoare de dividende. Emitentul intenționează să reinvestească profiturile în creșterea și dezvoltarea viitoare a societății.</p> <p><b>Forma și securitizarea</b> AWEARE Global Tokens vor fi emise sub formă de jetoane. Jetoanele sunt drepturi valorice care sunt emise într-o bază de date descentralizată (Blockchain) și transferate acolo. Blockchain-ul utilizat în acest scop este Ethereum Blockchain.</p> <p><b>Excluderea drepturilor de subscriere și a drepturilor de participare</b> Până la atingerea capitalului de participare țintă de 50 000 USD, drepturile preferențiale în conformitate cu articolele 304d, 304f și 304g din PCL, în special drepturile de subscriere și de participare ale participanților, sunt excluse.</p> <p><b>Transferabilitatea valorilor mobiliare</b> Transferul (cum ar fi transferul în sens restrâns, gajarea, moștenirea) de AWEARE Global Tokens necesită aprobarea Consiliului de administrație al emitentului. Prin urmare, transferabilitatea este limitată într-o anumită măsură. În orice caz, un transfer de AWEARE Global Tokens nu este permis dacă acestea ar fi apoi deținute de o persoană dintr-o țară în care AWEARE Global Tokens nu pot fi oferite. De asemenea, se consideră că are loc un transfer în sensul de mai sus în cazul în care un deținător de jetoane își mută locul de reședință într-o țară în care nu pot fi oferite jetoane globale AWEARE.</p>
d)	Prioritatea relativă a valorilor mobiliare în structura de capital a emitentului în caz de insolvență	În caz de insolvență a emitentului, participanții răspund cu capitalul lor investit. Capitalul investit trebuie tratat ca capital propriu și, prin urmare, este subordonat în mod calificat.
e)	Descrierea politicii în materie de dividende	Până în prezent nu au fost plătite dividende. Emitentul nu face previziuni sau estimări ale profitului și, prin urmare, nu se face o descriere a politicii privind dividendele. Dividendele, dacă există, vor fi plătite în USD. Emitentul își rezervă dreptul de a plăti dividende și în altă monedă sau criptomonedă. Orice decizie de plată a dividendelor va fi luată în conformitate cu legislația aplicabilă și va depinde, printre altele, de rezultatele operațiunilor, poziția financiară, restricțiile contractuale și cerințele de capital ale emitentului. În orice caz, 5% din profitul net va fi alocat



		rezervelor statutare până când acestea vor atinge valoarea de 10% din capitalul social vărsat.
<b>3.2</b>	<b>Unde vor fi tranzacționate valorile mobiliare?</b>	
<b>3.2.1</b>	AWEARE Global Tokens nu sunt admise la tranzacționare pe o piață reglementată. Emitentul își rezervă dreptul de a solicita admiterea la tranzacționare pe o piață reglementată.	
<b>3.4</b>	<b>Care sunt principalele riscuri specifice valorilor mobiliare?</b>	
<b>3.4.1</b>	<p><b>Portofelul investitorilor și riscul cheii private</b> Investitorul suportă singur riscul selecției portofelului sau al localizării cheii private. În cazul în care se utilizează un portofel incompatibil sau în cazul pierderii cheii private, accesul la jetoanele globale AWEARE este în mod normal imposibil. Consecințele, cum ar fi pierderea totală a investiției, trebuie să fie suportate exclusiv de către investitor.</p> <p><b>Risc de vandabilitate, risc de lichiditate și de realizare</b> Nu există nicio certitudine că se va dezvolta o piață lichidă pentru AWEARE Global Tokens. Prin urmare, AWEARE Global Tokens nu ar putea fi vândute pe o piață secundară, creând un risc de lichiditate pentru investitor.</p> <p><b>Riscul de volatilitate</b> Există riscuri legate de volatilitatea prețului acțiunilor. În cazul în care token-urile AWEARE Global ar fi vândute și ar fi prinse într-o fluctuație bruscă a prețului, deținătorul de token-uri ar putea suferi pierderi, dintre care unele ar putea fi substanțiale, ca urmare a vânzării.</p> <p><b>Pierderea de jetoane</b> Tokenurile pot fi pierdute sau pot deveni inaccesibile, în special în cazul în care deținătorul de tokenuri pierde cheia privată respectivă pentru a dispune de tokenurile sale AWEARE Global sau din cauza funcționării defectuoase a portofelului electronic în care sunt stocate tokenurile AWEARE Global. Acest lucru ar putea duce la pierderea token-urilor. Este responsabilitatea exclusivă a deținătorilor de jetoane să păstreze și să protejeze în siguranță cheia privată care permite accesul la portofelul electronic. Token-urile pot deveni inaccesibile și în cazul decesului unui deținător de token-uri, dacă acesta nu a luat măsuri în astfel de cazuri. Nici emitentul, nici un alt organism sau instituție nu va fi în măsură să restabilească accesul la portofelul deținătorului de jetoane pentru succesorii deținătorului de jetoane. În plus, pierderea cheilor private ar putea reduce disponibilitatea diferitelor funcționalități ale OST și ale AWEARE Global Tokens. În special, ar putea fi imposibil să se emită jetoane globale AWEARE către abonați sau să se facă transferabile, caz în care acestea ar rămâne neutilizate pe termen nelimitat. În plus, poate fi imposibil să se efectueze plăți de dividende. În cele din urmă, există riscul ca un atacator să falsifice AWEARE Global Tokens pentru adrese care nu contribuie, să modifice statutul confirmării, să contribuie cu sume necontrolate la OST sau să permită atacatorului să retragă plățile de dividende nerevendicate.</p> <p><b>Drepturile limitate ale deținătorilor de jetoane</b> AWEARE Global Tokens sunt certificate de participare fără drept de vot și nu conferă deținătorilor de jetoane dreptul de a vota, de a convoca și de a participa la adunarea generală a emitentului. În plus, AWEARE Global Tokens nu acordă dreptul la informare, dreptul de inspecție și dreptul de a depune o cerere. Prin urmare, adunarea generală a emitentului poate adopta hotărâri care pot afecta în mod negativ drepturile deținătorilor de jetoane. Deținătorii de jetoane nu au posibilitatea de a controla utilizarea încasărilor din emisiunea de jetoane AWEARE Global. Transferul (cum ar fi transferul în sens restrâns, gajarea, moștenirea) de AWEARE Global Tokens necesită aprobarea Consiliului de administrație al emitentului. În orice caz, un transfer de AWEARE Global Tokens nu este permis dacă acestea ar fi apoi deținute de o persoană dintr-o țară în care AWEARE Global Tokens nu pot fi oferite. De asemenea, se consideră că are loc un transfer în sensul de mai sus în cazul în care un deținător de jetoane își mută locul de reședință într-o țară în care nu pot fi oferite jetoane globale AWEARE. Dreptul legal de subscriere al deținătorilor de jetoane în cazul unei majorări de capital în cadrul prezentei oferte este exclus.</p> <p><b>Creanțele deținătorilor de jetoane sunt subordonate</b> Drepturile deținătorilor de jetoane de a pretinde și de a primi plata dividendelor de la emitent sunt subordonate creanțelor tuturor deținătorilor de obligații nesubordonate ale emitentului. În cazul unei lichidări a emitentului, deținătorii de jetoane vor fi plătiți numai dacă și după ce toate obligațiile de rang superior ale emitentului au fost stinse.</p>	
<b>SECȚIUNEA 4 - INFORMAȚII ESENȚIALE PRIVIND OFERTA PUBLICĂ DE VALORI MOBILIARE</b>		
<b>4.1</b>	<b>În ce condiții și în ce calendar pot investi în acest titlu?</b>	
	<p><b>Țările în care sunt oferite valorile mobiliare</b> Oferta constă în oferte publice în Austria, Belgia, Bulgaria, Croația, Cipru, Republica Cehă, Danemarca, Estonia, Finlanda, Franța, Germania, Grecia, Ungaria, Islanda, Irlanda, Italia, Letonia, Liechtenstein, Lituania, Luxemburg, Malta, Olanda, Norvegia, Polonia, Portugalia, România, Slovacia, Slovenia, Spania, Suedia, Elveția, precum și plasamente private în anumite jurisdicții din afara acestora.</p> <p><b>Țări în care valorile mobiliare nu sunt oferite</b> Tokenurile globale AWEARE ale emitentului nu sunt și nu vor fi înregistrate în conformitate cu dispozițiile United States Securities Act din 1933, astfel cum a fost modificată, sau la autoritățile de reglementare a valorilor mobiliare din orice stat al</p>	

Statelor Unite ale Americii, sau în Australia, Japonia sau Canada. În consecință, acestea nu vor fi oferite, vândute sau livrate direct sau indirect publicului, cu excepția cazului în care se aplică o derogare de la cerințele de înregistrare. În special, prezentul Prospect nu constituie sau nu reprezintă o ofertă de vânzare sau de solicitare a unei oferte de cumpărare a AWEARE Global Tokens în Statele Unite ale Americii, Australia, Japonia și Canada și nu poate fi distribuit în aceste țări. În plus, prezentul Prospect nu constituie sau nu reprezintă o ofertă de vânzare sau de solicitare a unei oferte de cumpărare a AWEARE Global Tokens în Rusia, Iran sau Coreea de Nord, Belarus, Siria sau în orice teritoriu al acestora. Și nu poate fi distribuit în aceste teritorii.

#### Licitație

Procesul de subscriere pentru AWEARE Global Tokens va avea loc online la <https://kyc.awearetech.li/> (denumit în continuare "tabloul de bord").

#### Perioada ofertei

Perioada în care investitorii își pot depune ofertele de cumpărare pentru AWEARE Global Tokens va începe la data aprobării prospectului și se va încheia un an mai târziu ("perioada de ofertă"). În ultima zi a perioadei de ofertă, ofertele pot fi depuse până la ora 12:00, ora Liechtensteinului.

#### Prețul ofertei

Prețul de ofertă al unui jeton AWEARE este de **12,00 USD** (denumit în continuare "prețul de ofertă").

Pentru a încuraja investițiile timpurii, sunt disponibile următoarele reduceri:

Pentru investițiile cuprinse între 10 000 USDC și 49 999,99 USDC, investitorii vor beneficia de o reducere de 10%, ceea ce face ca prețul per jeton AWEARE să fie de 10,80 USD.

Pentru investiții de 50 000 USDC sau mai mult, investitorii vor beneficia de o reducere de 15%, ceea ce face ca prețul per jeton AWEARE să fie de 10,20 USD.

#### Disponibilitatea reducerilor

Reduceri de mai sus sunt disponibile **până când intervine una dintre următoarele situații, oricare dintre acestea intervine prima:**

- atingerea unui volum total de investiții de 5.000.000 USDC sau
- expirarea termenului de trei luni de la începutul ofertei.

#### Livrare și decontare

Fiecare investitor trebuie să finalizeze procesul de subscriere online la Dashboard. AWEARE Global Tokens vor fi alocate în afara lanțului ca o înregistrare în baza de date a emitentului, care poate fi vizibilă prin intermediul Tabloului de bord, în schimbul plății prețului de ofertă. AWEARE Global Tokens vor fi alocate on-chain în contractul inteligent cel târziu în termen de două luni de la sfârșitul perioadei de ofertă. Odată ce oferta totală de AWEARE Global Tokens (după atingerea capitalului țintă de participare) s-a încheiat și emitentul a decis să finalizeze contractul inteligent, AWEARE Global Tokens vor fi livrate în portofelul criptografic al investitorului.

#### Diluarea

Deoarece dreptul legal de subscriere al tuturor participanților este exclus în cazul unei majorări de capital în contextul acestei oferte, participanții la această ofertă nu vor fi diluați.

#### Total încasări nete și costuri de emisiune estimate

Veniturile nete totale ale ofertei de peste 1 400 000 de jetoane AWEARE Global se pot ridica la aproximativ **15 000 000 USD**, corespunzătoare implementării străngerii de fonduri. Costurile totale preconizate ale ofertei se ridică la aproximativ **1 500 000 USD** și vor fi decontate din încasări.

<b>4.2</b>	<b>De ce este elaborat acest prospect?</b>
<b>4.2.1</b>	<p>a) Veniturile nete estimate din emisiunea de titluri vor fi utilizate în principal pentru cercetare și dezvoltare și pentru protecția proprietății intelectuale. Ar putea fi necesar să se transfere până la 50% dintr-un buget alocat către o altă poziție, dacă este necesar.</p> <ul style="list-style-type: none"> <li>i) 10% Costul majorării</li> <li>ii) 11% General și administrativ</li> <li>iii) 41% Cercetare și dezvoltare</li> <li>iv) 17% Juridic (protecția globală a proprietății intelectuale)</li> <li>v) 21% Dezvoltarea afacerilor, vânzări și marketing</li> </ul> <p>b) Acționarii actuali ai AWEARE Technologies Inc. și Global Innovation Partners Limited sunt Mahesh Reddy și Dr. Daniel Hyman. Mahesh Reddy și Dr. Daniel Hyman sunt, de asemenea, directori și acționari minoritari ai emitentului.</p> <p>c) Equanimity AG primește un comision de tranzacție de 3% din totalul plăților în criptomonede și fiat acumulate. Marcel Füssinger, care este unul dintre directorii emitentului, este și director și proprietar al Equanimity AG.</p> <p>d) <b>Total încasări nete și costuri de emisiune estimate</b></p>

	<p>Venituri nete totale ale ofertei de peste 1 400 000 de jetoane AWEARE Global Tokens se pot ridica la aproximativ <b>15 000 000 USD</b>, corespunzător punerii în aplicare a străngerii de fonduri. Costurile totale preconizate ale ofertei se ridică la aproximativ <b>1 500 000 USD</b> și vor fi decontate din încasări.</p> <p>e) <b>Acorduri de subscriere</b> Oferta nu face obiectul unui contract ferm de subscriere. Nu există niciun acord în temeiul căruia un subscriitor să fie obligat să subscrie jetoane nevândute. Prin urmare, nu există nicio garanție că întreaga ofertă va fi plasată.</p>
--	--

## XX. ZHRNUTIE PROSPEKTU

Tento súhrn obsahuje všetky prvky, ktoré sa vyžadujú v súhrne pre tento typ cenných papierov a emitenta.

ČASŤ 1 - ÚVOD		
1.1	Názov a ISIN cenných papierov	1 400 000 nových verejne dostupných podielových listov sú podielové listy na doručiteľa bez hlasovacieho práva spoločnosti AWEARE Global AG. Názov týchto podielových listov je "AWEARE Global Tokens". ISIN je LI1363014385.
1.2	totožnosť a kontaktné údaje emitenta vrátane identifikátora právnickej osoby (LEI)	<b>AWEARE Global AG ("Emitent")</b> c/o Revalier Aktiengesellschaft Pradafant 11, 9490 Vaduz, Kniežatstvo Tel: +423 237 63 47 E-mail: <a href="mailto:info@awearetech.li">info@awearetech.li</a> LEI je: 391200PTNEZNXGJW1C39
1.3	Príslušný orgán	<b>Úrad pre finančný trh</b> (ďalej len "FMA") Landstrasse 109, 9490 Vaduz, Lichtenštajnské kniežatstvo Tel: +423 236 73 73 Fax: +423 236 73 74 E-mail: <a href="mailto:info@fma-li.li">info@fma-li.li</a>
1.4	Dátum schválenia prospektu	05/12/2024
1.5	Upozornenia	
1.5.1		<p>a) Zhrnutie by sa malo čítať ako úvod k tomuto prospektu. Akékoľvek rozhodnutie investovať do cenných papierov by malo vychádzať z posúdenia Prospektu ako celku zo strany investora.</p> <p>b) Investor môže prísť o celý investovaný kapitál alebo o jeho časť.</p> <p>c) Ak sa na súde podá žaloba týkajúca sa informácií obsiahnutých v prospekte, žalujúci investor môže byť podľa vnútroštátneho práva povinný znášať náklady na preklad prospektu pred začatím súdneho konania.</p> <p>d) Občianskoprávna zodpovednosť sa vzťahuje len na tie osoby, ktoré predložili súhrn vrátane jeho prekladu, ale len v prípade, ak je súhrn zavádzajúci, nepresný alebo nekonzistentný, ak sa číta spolu s ostatnými časťami prospektu alebo ak neposkytuje, ak sa číta spolu s ostatnými časťami prospektu, kľúčové informácie s cieľom pomôcť investorom pri zvažovaní, či investovať do cenných papierov.</p>
ODDIEL 2 - KLÚČOVÉ INFORMÁCIE O EMITENTOVI		
2.1	Kto je emitentom cenných papierov?	
2.1.1	Informácie o emitentovi	
		<p>a) Právny a obchodný názov Emitenta je "AWEARE Global AG". Emitent je akciová spoločnosť založená v Lichtenštajnskom kniežatstve a riadi sa právom Lichtenštajnskeho kniežatstva. Emitent má sídlo vo Vaduze, Lichtenštajnské kniežatstvo, a je zapísaný na Úrade spravodlivosti/obchodnom registri Lichtenštajnskeho kniežatstva pod registračným číslom FL-0002.714.015-4.</p> <p>b) Cieľom Emitenta je vyvíjať a speňažiť technológie senzorov a umelej inteligencie pre autonómne vozidlá a iné aplikácie.</p> <p>c) Hlavnými akcionármi Emitenta sú: <ul style="list-style-type: none"> <li>• Global Innovation Partners Limited, Britské Panenské ostrovy s väčšinovými akcionármi Dr. Danielom Hymanom, Maheshom Reddym, Dr. Reginaldom Tangom a Markom Hymanom</li> </ul> </p>

	<p>d) Predstavenstvo Emitenta sa skladá z:</p> <ul style="list-style-type: none"> <li>• Dr. Daniel Hyman, štátna príslušnosť: Spojené štáty, poštová adresa: Long Beach, Kalifornia, USA</li> <li>• Mahesh Reddy, štátna príslušnosť: Spojené štáty, poštová adresa: Adresa: Irvine, Kalifornia, USA</li> <li>• Marcel Füssinger, štátna príslušnosť: Rakúsko, poštová adresa: 160009, Singapur</li> <li>• Revalier AG v zastúpení: Reinhold Wohlwend, štátna príslušnosť: Lichtenštajnsko, korešpondenčná adresa: Lichtenštajnsko: 9490, Vaduz, Lichtenštajnsko</li> </ul> <p>e) Audítora je: Lucas Tihanyi, člen Lichtenštajnskej asociácie audítora a EXPERTsuisse, Industriering 14, 9491 Ruggell, Lichtenstein</p>																																				
<b>2.2</b>	<b>Aké sú kľúčové finančné informácie týkajúce sa emitenta?</b>																																				
<b>2.2.1</b>	<p>Emitent bol založený 30.11.2023 zápisom do obchodného registra Lichtenštajnského kniežatstva. Podľa vyhlásenia predstavenstva zo dňa 25. 10. 2023 Emitent nepodlieha bežnému auditu a nie je predmetom audítorskej kontroly. Ročná účtovná závierka k 31. decembru 2023 a priebežná účtovná závierka k 15. júlu 2023 však boli overené audítormi.</p> <p>Nasledujúce kľúčové finančné informácie boli vypracované v súlade s ustanoveniami lichtenštajnského zákona o osobách a spoločnostiach ("PCL"), najmä s čl. 1024 a nasl.</p> <p style="text-align: center;"><b>Výkaz ziskov a strát</b></p> <table border="1" style="margin-left: auto; margin-right: auto;"> <thead> <tr> <th></th> <th style="text-align: center;">31/12/2023</th> <th style="text-align: center;">15/07/2024</th> </tr> </thead> <tbody> <tr> <td><b>Celkové príjmy</b></td> <td style="text-align: center;">USD 0</td> <td style="text-align: center;">USD 0</td> </tr> <tr> <td><b>Prevádzkový zisk/strata</b></td> <td style="text-align: center;">USD -2'473,03</td> <td style="text-align: center;">USD -30'150.54</td> </tr> <tr> <td><b>Čistý zisk/strata</b></td> <td style="text-align: center;">USD -2'473,03</td> <td style="text-align: center;">USD -30'150.54</td> </tr> </tbody> </table> <p style="text-align: center;"><b>Súvaha</b></p> <table border="1" style="margin-left: auto; margin-right: auto;"> <thead> <tr> <th></th> <th style="text-align: center;">31/12/2023</th> <th style="text-align: center;">15/07/2024</th> </tr> </thead> <tbody> <tr> <td><b>Aktíva spolu</b></td> <td style="text-align: center;">50'184,35 USD</td> <td style="text-align: center;">75'244,30 USD</td> </tr> <tr> <td><b>Vlastné imanie spolu</b></td> <td style="text-align: center;">47 526,97 USD</td> <td style="text-align: center;">19'849,46 USD</td> </tr> <tr> <td><b>Čistý finančný dlh (dlhodobý dlh plus krátkodobý dlh mínus hotovosť)</b></td> <td style="text-align: center;">USD 0</td> <td style="text-align: center;">USD 0</td> </tr> </tbody> </table> <p style="text-align: center;"><b>Výkaz peňažných tokov</b></p> <table border="1" style="margin-left: auto; margin-right: auto;"> <thead> <tr> <th></th> <th style="text-align: center;">31/12/2023</th> <th style="text-align: center;">15/07/2024</th> </tr> </thead> <tbody> <tr> <td><b>Príslušné čisté peňažné toky z prevádzkovej činnosti</b></td> <td style="text-align: center;">USD 0</td> <td style="text-align: center;">USD 0</td> </tr> <tr> <td><b>Príslušné čisté peňažné toky z investičnej činnosti</b></td> <td style="text-align: center;">USD 0</td> <td style="text-align: center;">USD 0</td> </tr> <tr> <td><b>Príslušné čisté Peňažné toky z finančných činností</b></td> <td style="text-align: center;">USD 0</td> <td style="text-align: center;">USD 0</td> </tr> </tbody> </table> <p>Výhľad Emitenta sa od dátumu priebežnej súvahy k 15. 7. 2024 výrazne nezhoršil. Od dátumu zostavenia priebežnej súvahy k 15.7.2024 nedošlo k žiadnym významným zmenám vo finančnej situácii alebo obchodnej pozícii Emitenta.</p>		31/12/2023	15/07/2024	<b>Celkové príjmy</b>	USD 0	USD 0	<b>Prevádzkový zisk/strata</b>	USD -2'473,03	USD -30'150.54	<b>Čistý zisk/strata</b>	USD -2'473,03	USD -30'150.54		31/12/2023	15/07/2024	<b>Aktíva spolu</b>	50'184,35 USD	75'244,30 USD	<b>Vlastné imanie spolu</b>	47 526,97 USD	19'849,46 USD	<b>Čistý finančný dlh (dlhodobý dlh plus krátkodobý dlh mínus hotovosť)</b>	USD 0	USD 0		31/12/2023	15/07/2024	<b>Príslušné čisté peňažné toky z prevádzkovej činnosti</b>	USD 0	USD 0	<b>Príslušné čisté peňažné toky z investičnej činnosti</b>	USD 0	USD 0	<b>Príslušné čisté Peňažné toky z finančných činností</b>	USD 0	USD 0
	31/12/2023	15/07/2024																																			
<b>Celkové príjmy</b>	USD 0	USD 0																																			
<b>Prevádzkový zisk/strata</b>	USD -2'473,03	USD -30'150.54																																			
<b>Čistý zisk/strata</b>	USD -2'473,03	USD -30'150.54																																			
	31/12/2023	15/07/2024																																			
<b>Aktíva spolu</b>	50'184,35 USD	75'244,30 USD																																			
<b>Vlastné imanie spolu</b>	47 526,97 USD	19'849,46 USD																																			
<b>Čistý finančný dlh (dlhodobý dlh plus krátkodobý dlh mínus hotovosť)</b>	USD 0	USD 0																																			
	31/12/2023	15/07/2024																																			
<b>Príslušné čisté peňažné toky z prevádzkovej činnosti</b>	USD 0	USD 0																																			
<b>Príslušné čisté peňažné toky z investičnej činnosti</b>	USD 0	USD 0																																			
<b>Príslušné čisté Peňažné toky z finančných činností</b>	USD 0	USD 0																																			
<b>2.3</b>	<b>Aké sú kľúčové riziká, ktoré sú špecifické pre emitenta?</b>																																				
<b>2.3.1</b>	<p><b>Nízky kapitál</b> Cieľom Emitenta je komercializácia technológie AWEARE. Vlastný kapitál Emitenta je obmedzený na 50 000,00 USD, pričom minimálny kapitál požadovaný podľa lichtenštajnského práva je 50 000,00 USD. Keďže Emitent bol založený 30.11.2023, nie sú k dispozícii žiadne významné historické finančné údaje alebo kľúčové hodnoty, okrem</p>																																				

<p>historických finančných informácií uvedených v časti 2.2.1 tohto zhrnutia, ktoré by umožnili posúdiť finančnú situáciu Emitenta vo vzťahu k minulým rokom. Emitent nepodlieha bežnému auditu a nemá vykonanú auditorskú kontrolu. Emitent nebol hodnotený ratingovou agentúrou. Nízky vlastný kapitál predstavuje pre investora zvýšené riziko, pretože funkcia ako ručiteľského kapitálu je primerane znížená.</p> <p><b>Riziko platobnej neschopnosti</b></p> <p>V prípade začatia konkurzného konania na majetok Emitenta bude Emitent dočasne alebo trvalo obmedzený v nakladaní so svojím majetkom, alebo nakladanie s majetkom Emitenta prevezme súdom určený konkurzný správca. To môže mať negatívny vplyv na finančnú situáciu a podnikateľskú činnosť Emitenta. Tento prípad môže nastať aj v prípade, že insolvenčné návrhy boli podané nesprávne. V prípade platobnej neschopnosti Emitenta sú účastníci zodpovední svojím investovaným kapitálom. Investovaný kapitál sa považuje za vlastný kapitál, a preto je kvalifikovane podriadený.</p> <p><b>Financovanie podnikania</b></p> <p>Minimálny kapitál, ktorý je potrebné získať, nie je stanovený. Neexistuje žiadna záruka umiestnenia, ale skôr riziko, že globálne tokeny AWEARE nebudú plne upísané (riziko umiestnenia). Ak sa Emitentovi nepodarí získať požadovaný objem emisie, Emitent bude môcť investovať menej. Existuje riziko, že Emitentovi bude chýbať kapitál. Okrem toho zostanú zachované emisné náklady, ktoré sú nezávislé od výšky získaného kapitálu, čo zvýši pomer nákladov k celkovému získanému investičnému kapitálu. V takom prípade existuje riziko, že Emitent nedosiahne zamýšľané investičné ciele a nebude schopný plniť svoje záväzky vyplývajúce z globálnych tokenov AWEARE.</p> <p><b>Riadenie, technológia, závislosť od poskytovateľov služieb tretích strán, hospodárska súťaž a časové rámce vývoja</b></p> <p>Jednou z kľúčových predností Emitenta je dômyselné využívanie najnovšej radarovej technológie. Technické výhody v odvetví informačných a komunikačných technológií však môžu byť krátkodobé. Úspech Emisie bude preto čiastočne závisieť od jej schopnosti riadiť a rozširovať služby Emitenta a rozširovať používateľskú základňu jeho podnikania, a teda generovať príjmy v reakcii na meniace sa technológie, požiadavky používateľov a poskytovateľov služieb tretích strán a konkurenčné tlaky. Neúspech alebo oneskorenie v tomto smere môže mať negatívny vplyv na úspech Emitenta.</p> <p><b>Ľudská chyba pri inteligentných zmluvách</b></p> <p>Emitent nepreberá žiadnu zodpovednosť a neposkytuje žiadne vyhlásenia ani záruky, pokiaľ ide o funkčnosť projektu Emitenta alebo akýchkoľvek inteligentných kontraktov, ktoré môžu byť naprogramované alebo použité na vyrovnanie ponuky v súlade s týmto Prospektom v najširšom zmysle. Investori môžu v dôsledku toho utrpieť znehodnotenie alebo všeobecne čeliť úplnej strate. V takýchto scenároch sa však môžu uplatniť právne mechanizmy na ochranu investora pred stratou.</p>			
<b>ODDIEL 3 - KĹÚČOVÉ INFORMÁCIE O CENNÝCH PAPIEROCH</b>			
<b>3.1</b>	<b>Aké sú hlavné vlastnosti cenných papierov?</b>		
<b>3.1.1</b>	<b>Informácie o cenných papieroch</b>		
<b>a)</b>	<table border="1"> <tr> <td><b>Opis druhu a triedy cenných papierov</b></td> <td>1 400 000 nových podielových listov verejne ponúkaných Emitentom sú podielové listy na doručiteľa bez hlasovacieho práva, každý s nominálnou hodnotou <b>0,01 USD</b> podielového kapitálu ("<b>Globálne tokeny AWEARE</b>"), z novej emisie podielového kapitálu, o ktorej rozhodlo mimoriadne valné zhromaždenie dňa 18.7.2024. Držitelia globálnych žetónov AWEARE sa nazývajú "<b>účastníci</b>" alebo "<b>držitelia žetónov</b>".</td> </tr> </table>	<b>Opis druhu a triedy cenných papierov</b>	1 400 000 nových podielových listov verejne ponúkaných Emitentom sú podielové listy na doručiteľa bez hlasovacieho práva, každý s nominálnou hodnotou <b>0,01 USD</b> podielového kapitálu (" <b>Globálne tokeny AWEARE</b> "), z novej emisie podielového kapitálu, o ktorej rozhodlo mimoriadne valné zhromaždenie dňa 18.7.2024. Držitelia globálnych žetónov AWEARE sa nazývajú " <b>účastníci</b> " alebo " <b>držitelia žetónov</b> ".
<b>Opis druhu a triedy cenných papierov</b>	1 400 000 nových podielových listov verejne ponúkaných Emitentom sú podielové listy na doručiteľa bez hlasovacieho práva, každý s nominálnou hodnotou <b>0,01 USD</b> podielového kapitálu (" <b>Globálne tokeny AWEARE</b> "), z novej emisie podielového kapitálu, o ktorej rozhodlo mimoriadne valné zhromaždenie dňa 18.7.2024. Držitelia globálnych žetónov AWEARE sa nazývajú " <b>účastníci</b> " alebo " <b>držitelia žetónov</b> ".		
<b>b)</b>	<table border="1"> <tr> <td><b>Mena emisie cenných papierov</b></td> <td>Americký dolár ("<b>USD</b>" alebo "\$"). Doba platnosti globálneho tokenu AWEARE je neobmedzená.</td> </tr> </table>	<b>Mena emisie cenných papierov</b>	Americký dolár (" <b>USD</b> " alebo "\$"). Doba platnosti globálneho tokenu AWEARE je neobmedzená.
<b>Mena emisie cenných papierov</b>	Americký dolár (" <b>USD</b> " alebo "\$"). Doba platnosti globálneho tokenu AWEARE je neobmedzená.		
<b>c)</b>	<table border="1"> <tr> <td><b>Opis práv spojených s cennými papiermi</b></td> <td> <p><b>Právo voliť</b></p> <p>Globálne tokeny AWEARE sú podielové listy bez hlasovacieho práva a neopravňujú Účastníka hlasovať na valnom zhromaždení Emitenta, zvolávať ho a zúčastňovať sa na ňom. Globálne tokeny AWEARE okrem toho nezakladajú právo na informácie, právo na nahliadnutie a právo podať žiadosť. Na Valnom zhromaždení však možno podať písomnú žiadosť o informácie alebo o nahliadnutie alebo o začatie úradného auditu.</p> <p><b>Oznámenie o zvolaní a uzneseniach valného zhromaždenia</b></p> <p>Účastníci musia byť informovaní o zvolaní valného zhromaždenia spolu s bodmi programu a návrhmi. Každé uznesenie valného zhromaždenia musí byť Účastníkom bezodkladne k dispozícii na nahliadnutie v sídle Emitenta. Účastníci sú o tom informovaní v oznámení.</p> <p><b>Nárok na dividendu a podiel na likvidačných výnosoch</b></p> <p>Globálne tokeny AWEARE nesú plné právo na dividendu od dátumu ich platného nadobudnutia a oprávňujú ich držiteľov na podiel na likvidačnom zisku v pomere k ich podielu na základnom imaní. Emitent v súčasnosti neplánuje v blízkej budúcnosti vyplácať dividendy. Hoci nárok na dividendy podľa stanov existuje, v</p> </td> </tr> </table>	<b>Opis práv spojených s cennými papiermi</b>	<p><b>Právo voliť</b></p> <p>Globálne tokeny AWEARE sú podielové listy bez hlasovacieho práva a neopravňujú Účastníka hlasovať na valnom zhromaždení Emitenta, zvolávať ho a zúčastňovať sa na ňom. Globálne tokeny AWEARE okrem toho nezakladajú právo na informácie, právo na nahliadnutie a právo podať žiadosť. Na Valnom zhromaždení však možno podať písomnú žiadosť o informácie alebo o nahliadnutie alebo o začatie úradného auditu.</p> <p><b>Oznámenie o zvolaní a uzneseniach valného zhromaždenia</b></p> <p>Účastníci musia byť informovaní o zvolaní valného zhromaždenia spolu s bodmi programu a návrhmi. Každé uznesenie valného zhromaždenia musí byť Účastníkom bezodkladne k dispozícii na nahliadnutie v sídle Emitenta. Účastníci sú o tom informovaní v oznámení.</p> <p><b>Nárok na dividendu a podiel na likvidačných výnosoch</b></p> <p>Globálne tokeny AWEARE nesú plné právo na dividendu od dátumu ich platného nadobudnutia a oprávňujú ich držiteľov na podiel na likvidačnom zisku v pomere k ich podielu na základnom imaní. Emitent v súčasnosti neplánuje v blízkej budúcnosti vyplácať dividendy. Hoci nárok na dividendy podľa stanov existuje, v</p>
<b>Opis práv spojených s cennými papiermi</b>	<p><b>Právo voliť</b></p> <p>Globálne tokeny AWEARE sú podielové listy bez hlasovacieho práva a neopravňujú Účastníka hlasovať na valnom zhromaždení Emitenta, zvolávať ho a zúčastňovať sa na ňom. Globálne tokeny AWEARE okrem toho nezakladajú právo na informácie, právo na nahliadnutie a právo podať žiadosť. Na Valnom zhromaždení však možno podať písomnú žiadosť o informácie alebo o nahliadnutie alebo o začatie úradného auditu.</p> <p><b>Oznámenie o zvolaní a uzneseniach valného zhromaždenia</b></p> <p>Účastníci musia byť informovaní o zvolaní valného zhromaždenia spolu s bodmi programu a návrhmi. Každé uznesenie valného zhromaždenia musí byť Účastníkom bezodkladne k dispozícii na nahliadnutie v sídle Emitenta. Účastníci sú o tom informovaní v oznámení.</p> <p><b>Nárok na dividendu a podiel na likvidačných výnosoch</b></p> <p>Globálne tokeny AWEARE nesú plné právo na dividendu od dátumu ich platného nadobudnutia a oprávňujú ich držiteľov na podiel na likvidačnom zisku v pomere k ich podielu na základnom imaní. Emitent v súčasnosti neplánuje v blízkej budúcnosti vyplácať dividendy. Hoci nárok na dividendy podľa stanov existuje, v</p>		

		<p>súvislosti s budúcim vyplácaním dividend sa nepredpokladajú žiadne prognózy. Emitent má v úmysle reinvestovať zisk do ďalšieho rastu a rozvoja spoločnosti.</p> <p><b>Forma a sekuritizácia</b> Tokeny AWEARE Global budú vydané ako žetóny. Tokeny sú hodnotové práva, ktoré sa vydávajú v decentralizovanej databáze (Blockchain) a prenášajú sa tam. Na tento účel sa používa Blockchain Ethereum Blockchain.</p> <p><b>Vylúčenie práv na upisovanie a práv na účasť</b> Až do dosiahnutia cieľového základného imania vo výške 50 000 USD sú prednostné práva podľa článkov 304d, 304f a 304g ZCP, najmä upisovacie práva a práva na účasť účastníkov, vylúčené.</p> <p><b>Prevoditeľnosť cenných papierov</b> Prevod (napríklad prevod v užšom zmysle slova, založenie, dedenie) globálnych žetónov AWEARE si vyžaduje súhlas predstavenstva Emitenta. Prevoditeľnosť je preto do určitej miery obmedzená. V každom prípade nie je prevod Globálnych Tokenov AWEARE povolený, ak by ich potom vlastnila osoba v krajine, v ktorej Globálne Tokeny AWEARE nesmú byť ponúkané. Za prevod vo vyššie uvedenom zmysle sa považuje aj prípad, ak Držiteľ Tokenov zmení svoje bydlisko do krajiny, v ktorej sa Globálne Tokeny AWEARE nesmú ponúkať.</p>
d)	<b>Relatívna nadradenosť cenných papierov v kapitálovej štruktúre emitenta v prípade platobnej neschopnosti</b>	V prípade platobnej neschopnosti emitenta sú účastníci zodpovední svojím investovaným kapitálom. S investovaným kapitálom sa má zaobchádzať ako s vlastným kapitálom, a preto je kvalifikovane podriadený.
e)	<b>Opis dividendovej politiky</b>	Doteraz neboli vyplatené žiadne dividendy. Emitent nerobí žiadne prognózy ani odhady zisku, a preto sa neuvádza popis dividendovej politiky. Prípadné dividendy budú vyplatené v USD. Emitent si vyhradzuje právo vyplatiť dividendy aj v inej mene alebo kryptomene. Akékoľvek rozhodnutie o výplate dividend bude prijaté v súlade s platnými právnymi predpismi a bude závisieť okrem iného od výsledkov hospodárenia Emitenta, jeho finančnej situácie, zmluvných obmedzení a kapitálových požiadaviek. V každom prípade sa 5 % čistého zisku pridelí do zákonných rezerv, kým nedosiahne výšku 10 % splateného základného imania.
<b>3.2</b>	<b>Kde sa bude s cennými papiermi obchodovať?</b>	
<b>3.2.1</b>	Tokeny AWEARE Global nie sú prijaté na obchodovanie na regulovanom trhu. Emitent si vyhradzuje právo požiadať o prijatie na obchodovanie na regulovanom trhu.	
<b>3.4</b>	<b>Aké sú kľúčové riziká, ktoré sú špecifické pre cenné papiere?</b>	
<b>3.4.1</b>	<p><b>Riziko peňaženky investorov a súkromného kľúča</b> Riziko výberu peňaženky alebo umiestnenia súkromného kľúča nesie investor sám. Ak sa použije nekompatibilná peňaženka alebo ak sa stratí súkromný kľúč, prístup ku globálnym tokenom AWEARE je zvyčajne nemožný. Dôsledky, ako napríklad úplná strata investície, musí znášať výlučne investor.</p> <p><b>Riziko predajnosti, riziko likvidity a riziko realizácie</b> Neexistuje žiadna istota, že sa pre tokeny AWEARE Global vytvorí likvidný trh. V dôsledku toho by sa tokeny AWEARE Global Tokens nemohli predávať na sekundárnom trhu, čím by pre investora vzniklo riziko likvidity.</p> <p><b>Riziko volatility</b> V súvislosti s volatilitou ceny akcií existujú riziká. Ak by došlo k predaju tokenov AWEARE Global a tieto by sa dostali do prudkého výkyvu ceny smerom nadol, držiteľ tokenov by mohol v dôsledku predaja utpieť straty, z ktorých niektoré by mohli byť značné.</p> <p><b>Strata žetónov</b> Tokeny sa môžu stratiť alebo stať nedostupnými, najmä ak Držiteľ Tokenov stratí príslušný súkromný kľúč na nakladanie so svojimi AWEARE Global Tokenmi alebo z dôvodu poruchy elektronickej peňaženky, v ktorej sú AWEARE Global Tokeny uložené. To by mohlo mať za následok stratu Tokenov. Za bezpečné uloženie a ochranu súkromného kľúča, ktorý umožňuje prístup do elektronickej peňaženky, sú zodpovední výlučne držiteľia Tokenov. Tokeny sa môžu stať nedostupnými aj v prípade úmrtia držiteľa Tokenov, ak sa pre takéto prípady nepripravil. Emitent ani žiadny iný orgán alebo inštitúcia nebudú schopní obnoviť prístup k peňaženke držiteľa tokenov pre nástupcov držiteľa tokenov. Strata súkromných kľúčov môže ďalej znížiť dostupnosť rôznych funkcií STO a globálnych tokenov AWEARE. Predovšetkým môže byť nemožné vydávať AWEARE Global Tokeny účastníkom alebo ich umožniť prenos, v takom prípade by zostali pozastavené na neurčitú dobu. Okrem toho môže byť nemožné vyplácať dividendy. Napokon, existuje riziko, že útočník môže raziť AWEARE Global Tokeny pre adresy, ktoré neprispievajú, meniť stav potvrdenia, prispievať nekontrolovanými sumami do STO alebo umožniť útočníkovi vybrať nevyzdvihnuté platby dividend.</p> <p><b>Obmedzené práva Majiteľov Tokenov</b> Globálne Tokeny AWEARE sú podielové listy bez hlasovacieho práva a neopravňujú Majiteľov Tokenov hlasovať</p>	

na Valnom zhromaždení Emitenta, zvolávať ho a zúčastňovať sa na ňom. Globálne tokeny AWEARE okrem toho neposkytujú právo na informácie, právo na nahliadnutie a právo podať žiadosť. Valné zhromaždenie Emitenta preto môže prijať uznesenia, ktoré môžu mať nepriaznivý vplyv na práva Majiteľov Tokenov. Majitelia tokenov nemajú možnosť kontrolovať použitie výnosov z emisie globálnych tokenov AWEARE. Prevod (napr. prevod v užšom zmysle, záložné právo, dedenie) Globálnych žetónov AWEARE si vyžaduje súhlas predstavenstva Emitenta. V žiadnom prípade nie je povolený prevod AWEARE Global Tokens, ak by ich potom vlastnila osoba v krajine, v ktorej sa AWEARE Global Tokens nesmú ponúkať. Za prevod vo vyššie uvedenom zmysle sa považuje aj prípad, ak Držiteľ Tokenov zmení svoje bydlisko do krajiny, v ktorej sa Globálne Tokeny AWEARE nesmú ponúkať. Zákonné právo Držiteľov Tokenov na úpis v prípade navýšenia kapitálu v rámci tejto ponuky je vylúčené.

**Pohľadávky Majiteľov tokenov sú podriadené**

Práva Majiteľov tokenov na uplatnenie nárokov a výplatu dividend od Emitenta sú podriadené nárokom všetkých držiteľov nepodriadených záväzkov Emitenta. V prípade likvidácie Emitenta budú Majitelia tokenov vyplatení len vtedy a až po splnení všetkých nadriadených záväzkov Emitenta.

**ODDIEL 4 - KLÚČOVÉ INFORMÁCIE O VEREJNEJ PONUKE CENNÝCH PAPIEROV**

**4.1 Za akých podmienok a v akom časovom rozvrhu môžem investovať do tohto cenného papiera?**

**Krajiny, v ktorých sa cenné papiere ponúkajú**

Ponuka pozostáva z verejných ponúk v Belgicku, Bulharsku, Českej republike, Dánsku, Estónsku, Fínsku, Francúzsku, Grécku, Holandsku, Chorvátsku, Írsku, Islande, Lichtenštajnsku, Litve, Lotyšsku, Luxembursku, Maďarsku, Malte, Nemecku, Nórsku, Poľsku, Portugalsku, Rakúsku, Rumunsku, na Slovensku, v Slovinsku, Španielsku, Švajčiarsku, Švédsku a Taliansku, ako aj z neverejných ponúk v niektorých jurisdikciách mimo týchto krajín.

**Krajiny, v ktorých sa cenné papiere neponúkajú**

Globálne tokeny AWEARE Emitenta nie sú a nebudú registrované podľa ustanovení Zákona o cenných papieroch Spojených štátov amerických z roku 1933 v platnom znení ani u regulačných orgánov cenných papierov žiadneho štátu Spojených štátov amerických, Austrálie, Japonska alebo Kanady. V súlade s tým nebudú ponúkané, predávané ani dodávané priamo alebo nepriamo verejnosti, s výnimkou prípadov, keď sa na ne vzťahuje výnimka z registračných požiadaviek. Tento Prospekt najmä nepredstavuje ani nezakladá ponuku na predaj alebo výzvu na predloženie ponuky na kúpu globálnych žetónov AWEARE v Spojených štátoch amerických, Austrálii, Japonsku a Kanade a nesmie byť v nich distribuovaný. Okrem toho tento Prospekt nepredstavuje ani nezakladá ponuku na predaj alebo výzvu na predloženie ponuky na kúpu AWEARE Global Tokens v Rusku, Iráne alebo Severnej Kórei, Bielorusku, Sýrii alebo na akýchkoľvek ich územiach. A nesmie sa v nich distribuovať.

**Ponuka**

Proces predplatenia AWEARE Global Tokens sa uskutoční online na stránke <https://kyc.awearetech.li/> ("Dashboard").

**Obdobie ponuky**

Obdobie, počas ktorého môžu investori predkladať svoje ponuky na kúpu globálnych tokenov AWEARE, sa začne v deň schválenia prospektu a skončí sa o rok neskôr ("obdobie ponuky"). V posledný deň Ponukového obdobia je možné predkladať ponuky do 12:00 lichtenštajnského času.

**Ponuková cena**

Ponuková cena jedného tokenu AWEARE je **12,00 USD** ("Ponuková cena").

Na podporu včasnej investície sú k dispozícii tieto zľavy:

Pri investíciách od 10 000 USDC do 49 999,99 USDC získajú investori zľavu 10 %, takže cena za jeden token AWEARE bude 10,80 USD.

Pri investícii 50 000 USDC alebo viac získajú investori zľavu 15 %, takže cena za jeden token AWEARE bude 10,20 USD.

**Dostupnosť zliav**

Vyššie uvedené zľavy sú k dispozícii, **kým nenastane jedna z nasledujúcich skutočností, podľa toho, ktorá nastane skôr:**

- dosiahnutie celkového objemu investícií vo výške 5 000 000 USDC alebo
- uplynutie troch mesiacov od začiatku ponuky.

**Dodanie a zúčtovanie**

Každý investor musí dokončiť proces online predplatného na informačnom paneli. Tokeny AWEARE Global budú pridelené mimo reťazca ako záznam v databáze emitenta, ktorý je viditeľný prostredníctvom Dashboardu, proti zaplateniu ponukovej ceny. Globálne tokeny AWEARE budú pridelené on-chain v inteligentnej zmluve najneskôr do dvoch mesiacov po skončení Ponukového obdobia. Po skončení celkovej ponuky AWEARE Global Tokens (po dosiahnutí cieľového základného imania) a po rozhodnutí Emitenta o finalizácii Smart Contract budú AWEARE Global Tokens doručené do krypto peňaženky investora.

**Riedenie**

Keďže zákonné právo na upísanie akcií všetkých účastníkov je v prípade zvýšenia kapitálu v rámci tejto ponuky vylúčené, nedôjde k zriadeniu účastníkov tejto ponuky.

**Celkové čisté výnosy a odhadované náklady na emisiu**

Celkový čistý výnos z ponuky nad 1 400 000 globálnych tokenov AWEARE môže predstavovať približne **15 000 000 USD**, čo zodpovedá realizácii navýšenia finančných prostriedkov. Očakávané celkové náklady ponuky predstavujú približne **1 500 000 USD** a budú hrazené z výnosov.

<b>4.2</b>	<b>Prečo sa tento prospekt pripravuje?</b>
<b>4.2.1</b>	<p>a) Odhadovaný čistý výnos z emisie cenných papierov sa použije predovšetkým na výskum a vývoj a ochranu duševného vlastníctva. V prípade potreby môže byť potrebné presunúť až 50 % prideleného rozpočtu na inú položku.</p> <ul style="list-style-type: none"> <li>i) 10% Náklady na zvýšenie</li> <li>ii) 11% Všeobecné a administratívne služby</li> <li>iii) 41 % Výskum a vývoj</li> <li>iv) 17% Právne služby (globálna ochrana duševného vlastníctva)</li> <li>v) 21% Rozvoj autobusovej dopravy, predaj a marketing</li> </ul> <p>b) Medzi súčasných akcionárov spoločností AWEARE Technologies Inc. a Global Innovation Partners Limited patria Mahesh Reddy a Dr. Daniel Hyman. Mahesh Reddy a Dr. Daniel Hyman sú zároveň riaditeľmi a menšinovými akcionármi Emitenta.</p> <p>c) Spoločnosť Equanimity AG dostáva transakčný poplatok vo výške 3 % z celkovej sumy naakumulovaných platieb v krypto menách a fiat menách. Marcel Füssinger, ktorý je jedným z riaditeľov Emitenta, je zároveň riaditeľom a vlastníkom spoločnosti Equanimity AG.</p> <p>d) <b>Celkové čisté výnosy a odhadované náklady na emisiu</b> Celkový čistý výnos z ponuky nad 1 400 000 globálnych tokenov AWEARE môže predstavovať približne <b>15 000 000 USD</b>, čo zodpovedá realizácii navýšenia finančných prostriedkov. Očakávané celkové náklady ponuky predstavujú približne <b>1 500 000 USD</b> a budú hrazené z výnosov.</p> <p>e) <b>Dohody o upisovaní</b> Ponuka nepodlieha záväznej dohode o upísaní. Neexistuje žiadna zmluva, na základe ktorej by bol upisovateľ povinný upísať nepredané tokeny. Preto neexistuje žiadna záruka, že bude umiestnená celá ponuka.</p>

## XXI. POVZETEK PROSPEKTA

Ta povzetek vsebuje vse elemente, ki jih je treba vključiti v povzetek za to vrsto vrednostnih papirjev in izdajatelja.

ODDELEK 1 - UVOD		
<b>1.1</b>	<b>Ime in ISIN vrednostnih papirjev</b>	<b>1.400.000</b> novih javno objavljenih potrdil o udeležbi so potrdila o udeležbi družbe AWEARE Global AG brez glasovalne pravice. Ime teh potrdil o udeležbi je <b>"AWEARE Global Tokens"</b> . ISIN je LI1363014385.
<b>1.2</b>	<b>Identiteta in kontaktni podatki izdajatelja, vključno z njegovim identifikatorjem pravnega subjekta (LEI).</b>	<b>AWEARE Global AG ("izdajatelj")</b> c/o Revalier Aktiengesellschaft Pradafant 11, 9490 Vaduz, Kneževina Telefon: +423 237 63 47 E-naslov: <a href="mailto:info@awearetech.li">info@awearetech.li</a> LEI je: 391200PTNEZNXGJW1C39
<b>1.3</b>	<b>Pristojni organ</b>	<b>Organ za finančni trg (FMA)</b> Landstrasse 109, 9490 Vaduz, Kneževina Lihtenštajn Telefon: +423 236 73 73 73 Faks: +423 236 73 74 E-naslov: <a href="mailto:info@fma-li.li">info@fma-li.li</a>
<b>1.4</b>	<b>Datum potrditve prospekta</b>	05/12/2024



<b>1.5</b>	<b>Opozorila</b>																		
<b>1.5.1</b>	<p>a) Povzetek je treba brati kot uvod v ta prospekt. Vlagatelj mora vsako odločitev o naložbi v vrednostne papirje sprejeti na podlagi preučitve prospekta kot celote.</p> <p>b) Vlagatelj lahko izgubi celoten vloženi kapital ali njegov del.</p> <p>c) Če je zahtevek v zvezi z informacijami iz prospekta vloženi na sodišču, bo moral vlagatelj tožnik v skladu z nacionalno zakonodajo morda kriti stroške prevoda prospekta pred začetkom sodnega postopka.</p> <p>d) Civilnopravno odgovarjajo le osebe, ki so predložile povzetek, vključno z njegovim prevodom, vendar le, če je povzetek zavajajoč, netočen ali neskladen, če se bere skupaj z drugimi deli prospekta, ali če skupaj z drugimi deli prospekta ne zagotavlja ključnih informacij, ki bi vlagateljem pomagale pri odločanju, ali naj vlagajo v vrednostne papirje.</p>																		
<b>ODDELEK 2 - KLJUČNI PODATKI O IZDAJATELJU</b>																			
<b>2.1</b>	<b>Kdo je izdajatelj vrednostnih papirjev?</b>																		
<b>2.1.1</b>	<b>Informacije o izdajatelju</b>																		
	<p>a) Pravno in poslovno ime izdajatelja je "AWEARE Global AG". Izdajatelj je delniška družba, ustanovljena v Kneževini Lihtenštajn, za katero velja zakonodaja Kneževine Lihtenštajn. Izdajatelj ima sedež v Vaduzu, Kneževina Lihtenštajn, in je registriran pri Uradu za pravosodje / Poslovnem registru Kneževine Lihtenštajn pod registrsko številko FL-0002.714.015-4.</p> <p>b) Namen izdajatelja je razvoj in monetizacija senzorskih tehnologij in umetne inteligence za avtonomna vozila in druge aplikacije.</p> <p>c) Glavni delničarji izdajatelja so:</p> <ul style="list-style-type: none"> <li>• Global Innovation Partners Limited, Britanski Deviški otoki, z večinskimi delničarji Dr. Danielom Hymanom, Maheshom Reddyjem, Dr. Reginaldom Tangom in Markom Hymanom</li> </ul> <p>d) Upravni odbor izdajatelja sestavljajo:</p> <ul style="list-style-type: none"> <li>• Dr. Daniel Hyman, državljanstvo: ZDA, Poštni naslov: ZDA: Hyman: Long Beach, Kalifornija, ZDA</li> <li>• Mahesh Reddy, državljanstvo: Poštni naslov: Združene države Amerike, Poštni naslov: Irvine, Kalifornija, ZDA</li> <li>• Marcel Füssinger, državljanstvo: Füssinger, matična številka: Avstrija, poštni naslov: Avstrija: 160009, Singapur</li> <li>• Revalier AG, ki ga zastopa Reinhold Wohlwend, državljanstvo: Liechtenstein, poštni naslov: Liechtenstein: 9490, Vaduz, Lihtenštajn</li> </ul> <p>e) Revizor je: Lucas Tihanyi, član Združenja revizorjev Lihtenštajna in EXPERTsuisse, Industriering 14, 9491 Ruggell, Liechtenstein</p>																		
<b>2.2</b>	<b>Katere so ključne finančne informacije o izdajatelju?</b>																		
<b>2.2.1</b>	<p>Izdajatelj je bil ustanovljen 30. 11. 2023 z vpisom v poslovni register Kneževine Lihtenštajn. V skladu z izjavo upravnega odbora z dne 25. oktobra 2023 izdajatelj ni predmet redne revizije in ni predmet revizijskega pregleda. Vendar je revizor revidiral letne računovodske izkaze na dan 31. decembra 2023 in vmesne računovodske izkaze na dan 15. julija 2023.</p> <p>Naslednje ključne finančne informacije so bile pripravljene v skladu z določbami lihtenštajnskega zakona o osebah in družbah ("PCL"), zlasti s čl. 1024 in naslednjih.</p> <p style="text-align: center;"><b>Izkaz poslovnega izida</b></p> <table border="1" style="width: 100%; border-collapse: collapse;"> <thead> <tr> <th style="width: 50%;"></th> <th style="width: 25%; text-align: center;">31/12/2023</th> <th style="width: 25%; text-align: center;">15/07/2024</th> </tr> </thead> <tbody> <tr> <td><b>Skupni prihodki</b></td> <td style="text-align: center;">USD 0</td> <td style="text-align: center;">USD 0</td> </tr> <tr> <td><b>Dobiček/izguba iz poslovanja</b></td> <td style="text-align: center;">USD -2'473,03</td> <td style="text-align: center;">USD -30'150,54</td> </tr> <tr> <td><b>Čisti dobiček/izguba</b></td> <td style="text-align: center;">USD -2'473,03</td> <td style="text-align: center;">USD -30'150,54</td> </tr> </tbody> </table> <p style="text-align: center;"><b>Bilanca stanja</b></p> <table border="1" style="width: 100%; border-collapse: collapse;"> <thead> <tr> <th style="width: 50%;"></th> <th style="width: 25%; text-align: center;">31/12/2023</th> <th style="width: 25%; text-align: center;">15/07/2024</th> </tr> </thead> <tbody> <tr> <td><b>Celotna sredstva</b></td> <td style="text-align: center;">50'184,35 USD</td> <td style="text-align: center;">75'244,30 USD</td> </tr> </tbody> </table>		31/12/2023	15/07/2024	<b>Skupni prihodki</b>	USD 0	USD 0	<b>Dobiček/izguba iz poslovanja</b>	USD -2'473,03	USD -30'150,54	<b>Čisti dobiček/izguba</b>	USD -2'473,03	USD -30'150,54		31/12/2023	15/07/2024	<b>Celotna sredstva</b>	50'184,35 USD	75'244,30 USD
	31/12/2023	15/07/2024																	
<b>Skupni prihodki</b>	USD 0	USD 0																	
<b>Dobiček/izguba iz poslovanja</b>	USD -2'473,03	USD -30'150,54																	
<b>Čisti dobiček/izguba</b>	USD -2'473,03	USD -30'150,54																	
	31/12/2023	15/07/2024																	
<b>Celotna sredstva</b>	50'184,35 USD	75'244,30 USD																	

	<table border="1"> <tr> <td><b>Lastniški kapital skupaj</b></td> <td>47.526,97 USD</td> <td>19'849,46 USD</td> </tr> <tr> <td><b>Neto finančni dolg (dolgoročni dolg plus kratkoročni dolg minus denar)</b></td> <td>USD 0</td> <td>USD 0</td> </tr> </table> <p style="text-align: center;"><b>Izkaz denarnih tokov</b></p> <table border="1"> <thead> <tr> <th></th> <th>31/12/2023</th> <th>15/07/2024</th> </tr> </thead> <tbody> <tr> <td><b>Ustrezni neto denarni tokovi iz poslovanja</b></td> <td>USD 0</td> <td>USD 0</td> </tr> <tr> <td><b>Ustrezni neto Denarni tokovi pri naložbenju</b></td> <td>USD 0</td> <td>USD 0</td> </tr> <tr> <td><b>Ustrezni neto Denarni tokovi pri financiranju</b></td> <td>USD 0</td> <td>USD 0</td> </tr> </tbody> </table> <p>Izdajateljevi obeti se od datuma vmesne bilance stanja na dan 15. 7. 2024 niso bistveno poslabšali. Od datuma poročanja vmesne bilance stanja na dan 15. 7. 2024 ni bilo bistvenih sprememb v finančnem položaju izdajatelja ali njegovem poslovnem položaju.</p>	<b>Lastniški kapital skupaj</b>	47.526,97 USD	19'849,46 USD	<b>Neto finančni dolg (dolgoročni dolg plus kratkoročni dolg minus denar)</b>	USD 0	USD 0		31/12/2023	15/07/2024	<b>Ustrezni neto denarni tokovi iz poslovanja</b>	USD 0	USD 0	<b>Ustrezni neto Denarni tokovi pri naložbenju</b>	USD 0	USD 0	<b>Ustrezni neto Denarni tokovi pri financiranju</b>	USD 0	USD 0
<b>Lastniški kapital skupaj</b>	47.526,97 USD	19'849,46 USD																	
<b>Neto finančni dolg (dolgoročni dolg plus kratkoročni dolg minus denar)</b>	USD 0	USD 0																	
	31/12/2023	15/07/2024																	
<b>Ustrezni neto denarni tokovi iz poslovanja</b>	USD 0	USD 0																	
<b>Ustrezni neto Denarni tokovi pri naložbenju</b>	USD 0	USD 0																	
<b>Ustrezni neto Denarni tokovi pri financiranju</b>	USD 0	USD 0																	
<b>2.3</b>	<b>Katera so ključna tveganja, značilna za izdajatelja?</b>																		
<b>2.3.1</b>	<p><b>Majhen kapital</b> Namen izdajatelja je komercializacija tehnologije družbe AWEARE. Lastniški kapital izdajatelja je omejen na 50.000,00 USD, pri čemer je minimalni kapital, ki se zahteva po lihtenštajnski zakonodaji, 50.000,00 USD. Ker je bil izdajatelj ustanovljen 30. 11. 2023, za oceno finančnega stanja izdajatelja v zvezi s preteklimi leti niso na voljo pomembni pretekli finančni podatki ali ključne številke, razen preteklih finančnih informacij iz poglavja 2.2.1 tega povzetka. Izdajatelj ni predmet redne revizije in nima revizijskega pregleda. Izdajatelja ni ocenila nobena bonitetna agencija. Nizek lastniški kapital predstavlja povečano tveganje za vlagatelja, saj je njegova funkcija jamstvenega kapitala ustrezno zmanjšana.</p> <p><b>Tveganje plačilne nesposobnosti</b> V primeru začetka postopka zaradi insolventnosti nad premoženjem izdajatelja bo izdajatelj začasno ali trajno omejen pri razpolaganju s svojim premoženjem ali pa bo razpolaganje s premoženjem izdajatelja prevzel sodno imenovani stečajni upravitelj. To lahko negativno vpliva na finančni položaj in poslovanje izdajatelja. Do tega primera lahko pride tudi, če so bile vloge za insolventnost vložene nepravilno. V primeru insolventnosti izdajatelja so udeleženci odgovorni s svojim vložnim kapitalom. Vloženi kapital je treba obravnavati kot lastniški kapital in je zato kvalificirano podrejen.</p> <p><b>Financiranje podjetij</b> Minimalnega kapitala, ki ga je treba zbrati, ni. Jamstva za plasiranje ni, temveč obstaja tveganje, da globalni žetoni AWEARE ne bodo v celoti vpisani (tveganje plasiranja). Če izdajatelju ne bo uspelo pridobiti želenega obsega izdaje, bo izdajatelj lahko vložil manj. Za izdajatelja obstaja tveganje, da bo prišlo do primanjkljaja kapitala. Poleg tega bodo stroški emisij, ki so neodvisni od višine zbranega kapitala, ostali, kar bo povečalo delež stroškov glede na celotni zbrani naložbeni kapital. Obstaja tveganje, da v tem primeru izdajatelj ne bo dosegel načrtovanih naložbenih ciljev in ne bo mogel izpolniti svojih obveznosti v okviru globalnih žetonov AWEARE.</p> <p><b>upravljanje, tehnologija, odvisnost od tretjih ponudnikov storitev, konkurenca in časovni okviri razvoja</b> Ena od izdajateljevih ključnih prednosti je spretna uporaba najnovejše radarske tehnologije. Vendar so tehnične prednosti v industriji informacijske in komunikacijske tehnologije lahko kratkotrajne. Zato bo uspeh izdaje deloma odvisen od njene sposobnosti upravljanja in širjenja izdajateljevih storitev ter povečevanja baze uporabnikov njegovega podjetja in s tem ustvarjanja prihodkov kot odziva na spreminjajoče se tehnologije, zahteve uporabnikov in tretjih ponudnikov storitev ter konkurenčne pritiske. Neuspeh ali zamude pri tem lahko negativno vplivajo na uspeh izdajatelja.</p> <p><b>Človeške napake pri pametnih pogodbah</b> Izdajatelj ne prevzema nobene odgovornosti in ne daje nobenih zagotovil ali jamstev glede funkcionalnosti izdajateljevega projekta ali pametnih pogodb, ki se lahko programirajo ali uporabljajo za poravnavo ponudbe v skladu s tem prospektom v najširšem smislu. Vlagatelji lahko zaradi tega utrpijo oslabitve ali se na splošno soočijo s popolno izgubo. Vendar se v takšnih scenarijih lahko uporabijo pravni mehanizmi za zaščito vlagatelja pred izgubo.</p>																		
<b>ODDELEK 3 - KLJUČNI PODATKI O VREDNOSTNIH PAPIRJIH</b>																			
<b>3.1</b>	<b>Katere so glavne značilnosti vrednostnih papirjev?</b>																		

3.1.1	<b>Informacije o vrednostnih papirjih</b>	
a)	<b>Opis vrste in razreda vrednostnih papirjev</b>	<b>1.400.000</b> novih potrdil o udeležbi, ki jih izdajatelj javno ponuja, so potrdila o udeležbi na prinosnika brez glasovalne pravice, vsako z nominalno vrednostjo <b>0,01 USD</b> udeležbenega kapitala (" <b>globalni žetoni AWEARE</b> ") iz nove izdaje udeležbenega kapitala, o kateri je odločila izredna skupščina delničarjev 18. 7. 2024. Imetniki globalnih žetonov AWEARE se imenujejo " <b>udeleženci</b> " ali " <b>imetniki žetonov</b> ".
b)	<b>Valuta izdaje vrednostnih papirjev</b>	Ameriški dolar (" <b>USD</b> " ali " <b>\$</b> "). Veljavnost globalnega žetona AWEARE je neomejena.
c)	<b>Opis pravic, ki izhajajo iz vrednostnih papirjev</b>	<p><b>Volilna pravica</b> Globalni žetoni AWEARE so potrdila o udeležbi brez glasovalne pravice in udeležencu ne dajejo pravice do glasovanja, sklica in udeležbe na skupščini izdajatelja. Poleg tega globalni žetoni AWEARE ne dajejo pravice do informacij, pravice do vpogleda in pravice do vložitve vloge. Vendar pa se lahko skupščini predloži pisna zahteva za informacije ali pregled ali za začetek uradne revizije.</p> <p><b>Obvestilo o sklicu in sklepih skupščine</b> Udeleženci morajo biti obveščeni o sklicu skupščine skupaj s točkami dnevnega reda in predlogi. Vsak sklep skupščine mora biti udeležencem nemudoma na voljo na vpogled na sedežu izdajatelja. Udeleženci morajo biti o tem obveščeni v obvestilu.</p> <p><b>Pravica do dividende in delež likvidacijskih prihodkov</b> Globalni žetoni AWEARE imajo polno pravico do dividend od datuma veljavne pridobitve in dajejo imetnikom pravico do deleža likvidacijskih prihodkov v sorazmerju z njihovim deležem v osnovnem kapitalu. Izdajatelj trenutno ne načrtuje izplačila dividend v bližnji prihodnosti. Čeprav v skladu s statutom obstaja pravica do dividend, se glede prihodnjih izplačil dividend ne predvideva ničesar. Izdajatelj namerava dobiček ponovno vložiti v nadaljnjo rast in razvoj družbe.</p> <p><b>Oblika in listinjenje</b> Žetoni AWEARE Global bodo izdani kot žetoni. Žetoni so vrednostne pravice, ki se izdajo v decentralizirani podatkovni zbirki (verigi blokov) in se vanjo prenesejo. Za ta namen se uporablja veriga blokov Ethereum Blockchain.</p> <p><b>Izključitev vpisnih pravic in pravic do udeležbe</b> Dokler ni dosežen ciljni osnovni kapital v višini 50.000 USD, so prednostne pravice v skladu s členi 304d, 304f in 304g PCL, zlasti vpisne pravice in pravice udeležencev do udeležbe, izključene.</p> <p><b>Prenosljivost vrednostnih papirjev</b> Za prenos (kot so prenos v ožjem smislu, zastava, dedovanje) globalnih žetonov AWEARE je potrebna odobritev izdajateljevega upravnega odbora. Prenosljivost je zato do določene mere omejena. V vsakem primeru prenos globalnih žetonov AWEARE ni dovoljen, če bi jih nato imela oseba v državi, v kateri se globalni žetoni AWEARE ne smejo ponujati. Za prenos v zgornjem smislu se šteje tudi, če imetnik žetonov premakne svoje prebivališče v državo, v kateri se globalni žetoni AWEARE ne smejo ponujati.</p>
d)	<b>Relativna nadrejenost vrednostnih papirjev v izdajateljevi kapitalski strukturi v primeru insolventnosti</b>	V primeru insolventnosti izdajatelja so udeleženci odgovorni s svojim vloženim kapitalom. Vloženi kapital se obravnava kot lastniški kapital in je zato kvalificirano podrejen.
e)	<b>Opis dividendne politike</b>	Do zdaj niso bile izplačane nobene dividende. Izdajatelj ne pripravlja nobenih napovedi ali ocen dobička, zato opis dividendne politike ni podan. Morebitne dividende bodo izplačane v ameriških dolarjih. Izdajatelj si pridržuje pravico, da dividende izplača tudi v drugi valuti ali kriptovaluti. Vsak sklep o izplačilu dividend bo sprejet v skladu z veljavno zakonodajo in bo med drugim odvisen od rezultatov poslovanja izdajatelja, njegovega finančnega položaja, pogodbenih omejitev in kapitalskih zahtev. V vsakem primeru bo 5 % čistega dobička namenjeno v zakonske rezerve, dokler ta ne bo dosegel višine 10 % vplačanega osnovnega kapitala.
3.2	<b>Kje se bo trgovalo z vrednostnimi papirji?</b>	
3.2.1	Z žetoni AWEARE Global se ne trguje na reguliranem trgu. Izdajatelj si pridržuje pravico, da zaprosi za uvrstitev v trgovanje na reguliranem trgu.	

3.4	<b>Katera so ključna tveganja, značilna za vrednostne papirje?</b>
3.4.1	<p><b>Tveganje vlagateljev v denarnico in zasebni ključ</b> Tveganje izbire denarnice ali lokacije zasebnega ključa nosi vlagatelj sam. Če je uporabljena nezdružljiva denarnica ali če je zasebni ključ izgubljen, je dostop do žetonov AWEARE Global praviloma nemogoč. Posledice, kot je popolna izguba naložbe, mora nositi izključno vlagatelj.</p> <p><b>Tveganje prodaje, likvidnostno tveganje in tveganje realizacije</b> Ni gotovo, da se bo za globalne žetone AWEARE razvil likviden trg. Zato globalnih žetonov AWEARE ni mogoče prodati na sekundarnem trgu, kar za vlagatelja pomeni likvidnostno tveganje.</p> <p><b>Tveganje nestanovitnosti</b> Obstajajo tveganja, povezana z nestanovitnostjo cene delnice. Če bi bili žetoni AWEARE Global prodani in bi jih zajelo močno nihanje cene navzdol, bi lahko imetnik žetonov zaradi prodaje utrpel izgube, od katerih bi lahko bile nekatere precejšnje.</p> <p><b>Izguba žetonov</b> Žetoni se lahko izgubijo ali postanejo nedostopni, zlasti če imetnik žetonov izgubi ustrezen zasebni ključ za razpolaganje s svojimi globalnimi žetoni AWEARE ali zaradi nepravilnega delovanja e-denarnice, v kateri so shranjeni globalni žetoni AWEARE. To lahko povzroči izgubo žetonov. Imetniki žetonov so sami odgovorni za varno hrambo in zaščito zasebnega ključa, ki omogoča dostop do e-denarnice. Žetoni lahko postanejo nedostopni tudi v primeru smrti imetnika žetonov, če ta ni poskrbel za takšne primere. Niti izdajatelj niti kateri koli drug organ ali institucija ne bosta mogla obnoviti dostopa do denarnice imetnika žetonov za naslednike imetnika žetonov. Izguba zasebnih ključev lahko poleg tega zmanjša razpoložljivost različnih funkcionalnosti STO in globalnih žetonov AWEARE. Zlasti se lahko zgodi, da naročnikom ne bo mogoče izdati globalnih žetonov AWEARE ali jih narediti prenosljive, v tem primeru pa bi ostali za nedoločen čas zamrznjeni. Poleg tega morda ne bo mogoče izplačati dividend. Nazadnje, obstaja tveganje, da lahko napadalec izdelava globalne žetone AWEARE za naslove, ki niso prispevali, spremeni status potrditve, prispeva nenadzorovane zneske v STO ali omogoči napadalcu, da umakne neprevzeta izplačila dividend.</p> <p><b>Omejene pravice imetnikov žetonov</b> Globalni žetoni AWEARE so potrdila o udeležbi brez glasovalne pravice in imetnikom žetonov ne dajejo pravice do glasovanja, sklica in udeležbe na skupščini izdajatelja. Poleg tega globalni žetoni AWEARE ne dajejo pravice do informacij, pravice do vpogleda in pravice do vložitve vloge. Skupščina izdajatelja lahko zato sprejme sklepe, ki lahko negativno vplivajo na pravice imetnikov žetonov. Imetniki žetonov nimajo možnosti nadzora nad uporabo prihodkov od izdaje globalnih žetonov AWEARE. Za prenos (kot so prenos v ožjem smislu, zastava, dedovanje) globalnih žetonov AWEARE je potrebna odobritev upravnega odbora izdajatelja. V vsakem primeru prenos globalnih žetonov AWEARE ni dovoljen, če bi jih nato imela oseba v državi, v kateri se globalni žetoni AWEARE ne smejo ponujati. Za prenos v zgornjem smislu se šteje tudi, če imetnik žetonov premakne svoje prebivališče v državo, v kateri se globalni žetoni AWEARE ne smejo ponujati. Zakonska pravica imetnikov žetonov do vpisa v primeru povečanja kapitala v okviru te ponudbe je izključena.</p> <p><b>Terjatve imetnikov žetonov so podrejene</b> Pravice imetnikov žetonov, da zahtevajo in prejmejo dividende od izdajatelja, so podrejene terjatvam vseh imetnikov nepodrejenih obveznosti izdajatelja. V primeru likvidacije izdajatelja bodo imetniki žetonov plačani le, če in ko bodo poravnane vse nadrejene obveznosti izdajatelja.</p>
<b>ODDELEK 4 - KLJUČNE INFORMACIJE O JAVNI PONUDBI VREDNOSTNIH PAPIRJEV</b>	
4.1	<b>Pod kakšnimi pogoji in v kakšnem časovnem okviru lahko vlagam v ta vrednostni papir?</b>
<p><b>Države, v katerih se ponujajo vrednostni papirji</b> Ponudbo sestavljajo javne ponudbe v Avstriji, Belgiji, Bolgariji, na Cipru, Češkem, Danskem, v Estoniji, na Finskem, v Franciji, Grčiji, na Hrvaškem, v Islandiji, na Irskem, v Italiji, na Madžarskem, v Lihtenštajnu, Litvi, Luksemburgu, na Malti, Nizozemskem, Norveškem, na Poljskem, Portugalskem, v Romuniji, na Slovaškem, v Sloveniji, Španiji, na Švedskem in v Švici ter zasebne ponudbe v nekaterih jurisdikcijah zunaj teh držav.</p> <p><b>Države, v katerih se vrednostni papirji ne ponujajo</b> Globalni žetoni AWEARE izdajatelja niso in ne bodo registrirani v skladu z določbami Zakona o vrednostnih papirjih Združenih držav Amerike iz leta 1933, kot je bil spremenjen, ali pri organih za nadzor vrednostnih papirjev katere koli države Združenih držav Amerike, Avstralije, Japonske ali Kanade. V skladu s tem ne bodo neposredno ali posredno ponujeni, prodani ali izročeni javnosti, razen na podlagi izvetja iz zahtev za registracijo. Zlasti ta prospekt ne predstavlja ali predstavlja ponudbe za prodajo ali poziv k oddaji ponudbe za nakup žetonov AWEARE Global Tokens v Združenih državah Amerike, Avstraliji, na Japonskem in v Kanadi ter se tam ne sme razširjati. Poleg tega ta prospekt ne predstavlja ponudbe za prodajo ali poziv k oddaji ponudbe za nakup globalnih žetonov AWEARE v Rusiji, Iranu ali Severni Koreji, Belorusiji, Siriji ali na katerih koli njihovih ozemljih. In se tam ne sme distribuirati.</p> <p><b>Ponudba</b> Postopek vpisa za globalne žetone AWEARE bo potekal na spletni strani <a href="https://kyc.awearetech.li/">https://kyc.awearetech.li/</a> ("nadzorna plošča").</p> <p><b>Obdobje ponudbe</b></p>	

Obdobje, v katerem lahko vlagatelji oddajo ponudbe za nakup globalnih žetonov AWEARE, se začne na dan potrditve prospekta in konča eno leto pozneje ("obdobje ponudbe"). Na zadnji dan obdobja ponudbe je ponudbe mogoče oddati do 12.00 po lihtenštajnskem času.

#### Ponudbena cena

Ponudbena cena enega žetona AWEARE je **12,00 USD** ("ponudbena cena").

Za spodbujanje zgodnje naložbe so na voljo naslednji popusti:

Za naložbe med 10.000 USDC in 49.999,99 USDC bodo vlagatelji prejeli 10-odstotni popust, tako da bo cena za žeton AWEARE 10,80 USD.

Za naložbe v višini 50.000 USDC ali več bodo vlagatelji prejeli 15-odstotni popust, tako da bo cena za žeton AWEARE 10,20 USD.

#### Razpoložljivost popustov

Zgoraj navedeni popusti so na voljo, **dokler ne nastopi ena od naslednjih okoliščin, karkoli nastopi prej:**

- doseganje skupnega obsega naložb v višini **5.000.000 USDC** ali
- tri mesece od začetka ponudbe.

#### Dostava in poravnava

Vsak vlagatelj mora opraviti postopek spletne naročnine na nadzorni plošči. Žetoni AWEARE Global bodo dodeljeni zunaj verige kot zapis v izdajateljevi podatkovni bazi, ki je viden prek nadzorne plošče, proti plačilu ponujene cene. Globalni žetoni AWEARE bodo dodeljeni na verigi v pametni pogodbi najpozneje v dveh mesecih po koncu obdobja ponudbe. Ko se bo celotna ponudba žetonov AWEARE Global (po doseganju ciljnega udeležbenega kapitala) končala in se bo izdajatelj odločil dokončati pametno pogodbo, bodo žetoni AWEARE Global dostavljeni v kripto denarnico vlagatelja.

#### Razredčenje

Ker je v primeru povečanja kapitala v okviru te ponudbe zakonska pravica do vpisa vseh udeležencev izključena, udeleženci te ponudbe ne bodo razredčeni.

#### Skupni neto iztržek in ocenjeni stroški izdaje

Skupni neto izkupiček od ponudbe nad 1.400.000 globalnih žetonov AWEARE lahko znaša približno **15.000.000 USD**, kar ustreza izvedbi zbiranja sredstev. Pričakovani skupni stroški ponudbe znašajo približno **1.500.000 USD** in bodo bremenili izkupiček.

<b>4.2</b>	<b>Zakaj je bil pripravljen ta prospekt?</b>
<b>4.2.1</b>	<p>a) Ocenjeni čisti prihodki od izdaje vrednostnih papirjev bodo uporabljeni predvsem za raziskave in razvoj ter zaščito intelektualne lastnine. Po potrebi bo morda treba do 50 % dodeljenega proračuna prenesti na drugo delovno mesto.</p> <ul style="list-style-type: none"><li>i) 10% Stroški povišanja</li><li>ii) 11 % Splošni in upravni stroški</li><li>iii) 41 % Raziskave in razvoj</li><li>iv) 17 % Pravno področje (globalna zaščita intelektualne lastnine)</li><li>v) 21 % Razvoj avtobusov, prodaja in trženje</li></ul> <p>b) Med sedanjimi delničarji družb AWEARE Technologies Inc. in Global Innovation Partners Limited sta Mahesh Reddy in Dr. Daniel Hyman. Mahesh Reddy in Dr. Daniel Hyman sta tudi direktorja in manjšinska delničarja izdajatelja.</p> <p>c) Družba Equanimity AG prejme pristojbino za transakcije v višini 3 % vseh obračunanih plačil v kriptovalutah in fiat valutah. Marcel Füssinger, ki je eden od direktorjev izdajatelja, je tudi direktor in lastnik družbe Equanimity AG.</p> <p>d) <b>Skupni neto iztržek in ocenjeni stroški izdaje</b> Skupni neto izkupiček od ponudbe nad 1.400.000 globalnih žetonov AWEARE lahko znaša približno <b>15.000.000 USD</b>, kar ustreza izvedbi zbiranja sredstev. Pričakovani skupni stroški ponudbe znašajo približno <b>1.500.000 USD</b> in bodo bremenili izkupiček.</p> <p>e) <b>Dogovori o zavarovanju</b> Ponudba ni predmet trdne pogodbe o prevzemu. Ne obstaja nobena pogodba, na podlagi katere bi bil izdajatelj obvezan prevzeti neprodane žetone. Zato ni zagotovila, da bo celotna ponudba plasirana.</p>

## XXII. SAMANTEKT Á LÝSINGARLÝSINGU

Þetta yfirlit inniheldur alla þá þætti sem þarf til að vera með í samantekt fyrir þessa tegund verðbréfa og útgefanda.

1. KAFLI – INNGANGUR		
1.1	Nafn og kennitala verðbréfanna	The <b>1.400.000</b> ný þáttökuskírteini opinberlega eru þáttökuskírteini AWEARE Global AG án atkvæðagreiðslu. Nafn þessara þáttökuskírteina er " <b>AWEARE Global Tokens</b> ". ISIN er LI1363014385.
1.2	Auðkenni og samskiptaupplýsingar útgefanda, þar á meðal lögaðila auðkenni hans (LEI)	<b>AWEARE Global AG</b> (það „Útgefandi“) c/o Revalier Aktiengesellschaft Pradafant 11, 9490 Vaduz, Furstadæmið Sími: +423 237 63 47 Netfang: info@awearetech.li LEI er: 391200PTNEZNXGJW1C39
1.3	Lögbært yfirvald	<b>Fjármálamarkaðseftirlitið</b> (það „FMA“) Landstrasse 109, 9490 Vaduz, Furstadæmið Liechtenstein Sími: +423 236 73 73 Fax: +423 236 73 74 Netfang: <a href="mailto:info@fma-li.li">info@fma-li.li</a>
1.4	Dagsetning samþykkis lýsingar	05/12/2024
1.5	Viðvaranir	
1.5.1		<p>a) Lesa skal samantektina sem inngang að þessari lýsingu. Sérhver ákvörðun um að fjárfesta í verðbréfunum ætti að byggjast á athugun fjárfestis á útboðslýsingu í heild sinni.</p> <p>b) Fjárfestirinn gæti tapað öllu eða hluta fjármagnsins sem fjárfest er.</p> <p>c) Hvar krafa sem tengist upplýsingum í lýsingu er lögð fyrir dómstóla gæti stefnandi fjárfestir, samkvæmt landslögum, þurft að bera kostnað við að þýða lýsingu áður en málsmeðferð er hafin.</p> <p>d) Skaðabótaábyrgð hvílir aðeins á þeim aðilum sem hafa lagt fram samantektina, þ. öðrum hlutum útboðslýsingarinnar, lykilupplýsingar til að aðstoða fjárfesta þegar þeir ihuga hvort þeir eigi að fjárfesta í verðbréfunum.</p>
2. HLUÐI – LYKILUPPLÝSINGAR UM ÚTGEFANDA		
2.1	Hver er útgefandi verðbréfanna?	
2.1.1	Upplýsingar um útgefanda	
		<p>a) Lagalegt og viðskiptaheiti útgefanda er „AWEARE Global AG“. Útgefandinn er hlutafélag sem er stofnað í Furstadæminu Liechtenstein og lýtur lögum Furstadæmisins Liechtenstein. Útgefandi er með skráða skrifstofu í Vaduz, Furstadæmi Liechtenstein og er skráður á skrifstofu dómsmála/viðskiptaskrár Furstadæmisins Liechtenstein undir skráningarnúmeri FL-0002.714.015-4.</p> <p>b) Tilgangur útgefanda er að þróa og afla tekna af skynjaratækni og gervigreind fyrir sjálfstýrð ökutæki og önnur forrit.</p> <p>c) Helstu hluthafar útgefanda eru:</p> <ul style="list-style-type: none"><li>Global Innovation Partners Limited, Bresku Jómfrúaeypjum með meirihluta hluthafa Dr. Daniel Hyman, Mahesh Reddy, Dr. Reginald Tang og Mark Hyman</li></ul> <p>d) Í stjórn útgefanda sitja:</p> <ul style="list-style-type: none"><li>Dr. Daniel Hyman, Þjóðerni: Bandaríkin, Póstfang: Long Beach, Kalifornía, Bandaríkin</li><li>Mahesh Reddy, Þjóðerni: Bandaríkin, Póstfang: Irvine, Kalifornía, Bandaríkin</li><li>Marcel Füssinger, Þjóðerni: Austurríki, Póstfang: 160009, Singapore</li><li>Revalier AG fulltrúi Reinhold Wohlwend, Þjóðerni: Liechtenstein, Póstfang: 9490, Vaduz, Liechtenstein</li></ul> <p>e) Endurskoðandi er: Lucas Tihanyi, meðlimur Liechtenstein Association of Auditors and EXPERTsuisse, Industriering 14, 9491 Ruggell, Liechtenstein</p>
2.2	Hverjar eru helstu fjárhagsupplýsingar varðandi útgefanda?	

Útgefandinn var stofnaður 30/11/2023 með færslu í viðskiptaskrá Furstadæmisins Liechtenstein. Samkvæmt yfirlýsingu stjórnar frá 25. október 2023 er útgefandi ekki háður venjulegri endurskoðun og ekki endurskoðað. Hins vegar voru ársreikningar 31. desember 2023 og árshlutareikningar 15. júlí 2023 endurskoðaðir af endurskoðanda.

Eftirfarandi lykilmjálfráttunir hafa verið unnar í samræmi við ákvæði Liechtensteins Persons and Companies Law („PCL“), einkum gr. 1024 o.fl.

### Rekstrarreikningur

	31/12/2023	15.07.2024
Heildartekjur	USD 0	USD 0
Rekstrarhagnaður/tap	USD -2'473,03	USD -30'150,54
Hreinn hagnaður/tap	USD -2'473,03	USD -30'150,54

### Efnahagsreikningur

	31/12/2023	15.07.2024
Heildareignir	USD 50.184,35	USD 75.244,30
Heildar eigið fé	USD 47.526,97	USD 19.849,46
Hreinar fjárskuldir (langtímaskuldir plús skammtímaskuldir að frádrögnum reiðufé)	USD 0	USD 0

### Sjóðstreymisyfirlit

	31/12/2023	15.07.2024
Viðeigandi nettó sjóðstreymi frá rekstri	USD 0	USD 0
Viðeigandi nettó sjóðstreymi frá fjárfestingarstarfsemi	USD 0	USD 0
Viðeigandi nettó sjóðstreymi frá fjármögnunarstarfsemi	USD 0	USD 0

Horfur útgefanda hafa ekki versnað verulega frá dagsetningu milliuppgjörs 15.07.2024. Engar marktækar breytingar hafa orðið á fjárhagsstöðu eða viðskiptastöðu útgefanda frá uppgjörsdegi milliefnahagsreiknings 15.07.2024.

### 2.3 Hver eru helstu áhættur sem eru sérstakar fyrir útgefandann?

**Lítið fjármagn**  
Tilgangur útgefanda er markaðsvæðing á tækni AWEARE. Eigið fé útgefanda er takmarkað við USD 50.000,00, þar sem lágmarksfjármagn sem krafist er samkvæmt lögum Liechtenstein er USD 50.000,00. Þar sem útgefandi var stofnað 30/11/2023 eru engar mikilvægar sögulegar fjárhagslegar upplýsingar eða lykiltölur, aðrar en sögulegar fjárhagsupplýsingar sem vísað er til í kafla 2.2.1 í þessari samantekt, tiltækar til að meta fjárhagsstöðu útgefanda í tengslum við til liðinna ára. Útgefandi er ekki háður venjulegri endurskoðun og hefur ekki endurskoðunarskoðun. Útgefandi hefur ekki verið metinn af matsfyrirtæki. Lágt eigið fé felur í sér aukna áhættu fyrir fjárfestirinn þar sem virkni sem ábyrgðarhluti minnkar að sama skapi.

### 2.3.1

#### Gjaldprottsáhætta

Komi til gjaldprotaskipta vegna eigna útgefanda verður útgefandi takmarkaður tímabundið eða varanlega við ráðstöfun eigna sinna, eða ráðstöfun eigna útgefanda verður tekin yfir af dómstóli sem skipaður er gjaldprotaskiptastjóri. Þetta getur haft neikvæð áhrif á fjárhagsstöðu og starfsemi útgefanda. Þetta tilvik getur komið upp þótt gjaldprottaumsóknir hafi verið ranglega settar inn. Komi til gjaldprotts útgefanda bera þátttakendur ábyrgð með fjárfestu fé sínu. Farið skal með fjárfest sem eigið fé og er því hæft víkjandi.

	<p><b>Fjármögnun fyrirtækja</b> Það er ekkert lágmarksfjármagn sem þarf að afla. Það er engin staðsetningarábyrgð, heldur hættan á að AWEARE Global Tokens verði ekki í fullri áskrift (staðsetningaráhætta). Ef útgefanda tekst ekki að sækja um æskilegt útgáfumagn, mun útgefandinn geta fjárfest minna. Hætta er á eiginfjárskorti hjá útgefanda. Að auki verður losunarkostnaður áfram, sem er óháður fjárhæð aflaðs fjármagns, sem hækkar kostnaðarlutfallið miðað við heildarfjárfestingarféð. Hætta er á að í þessu tilviki muni útgefandinn ekki ná ætluðum fjárfestingarmarkmiðum sínum og geti ekki staðið við skuldbindingar sínar samkvæmt AWEARE Global Tokens.</p> <p><b>Stjórnun, tækni, traust þriðja aðila þjónustuveitenda, samkeppni og þróunartímar</b> Einn af helstu styrkleikum útgefanda er skynsamleg notkun hans á nýjustu ratsjártækni. Hins vegar geta tæknilegir kostir í upplýsinga- og fjarskiptatækniöndunum verið skammvinnir. Samkvæmt því mun árangur útgáfunnar ráðast að hluta til af getu þess til að stjórna og auka þjónustu útgefandans og stækka notendahóp fyrirtækisins og afla því tekna til að bregðast við breyttri tækni, kröfum notenda og þriðja aðila þjónustuveitenda og samkeppnisþrýngi. Misbrestur eða tafir á því geta haft slæm áhrif á árangur útgefanda.</p> <p><b>Mannleg mistök með snjöllum samningum</b> Útgefandinn tekur enga ábyrgð og gefur enga yfirlýsingu eða ábyrgðir á virkni útgefendaverkefnisins eða snjallsamninga sem kunna að vera forritaðir eða notaðir við uppgjör útboðsins í samræmi við þessa útboðslýsingu í víðasta skilningi. Fjárfestar geta orðið fyrir virðisryrnun vegna þess eða almennt orðið fyrir algjöru tapi. Hins vegar, í slíkum tilfellum, geta lagaleg fyrirkomulag átt við til að vernda fjárfesti gegn tapi.</p>
<b>3. KAFLI – LYKILUPPLÝSINGAR UM VERÐBRÉFIN</b>	
3.1	Hver eru helstu eiginleikar verðbréfanna?
3.1.1	Upplýsingar um verðbréfin
a)	<p><b>Lýsing á gerð og flokki verðbréfanna</b></p> <p>The <b>1.400.000</b> ný hlutdeildarskírteini sem útgefandinn býður opinberlega eru hlutdeildarskírteini án atkvæðisréttar, hvert um sig að nafnvirði <b>USD 0,01</b> af hlutafé (þ. <b>AWEARE Global Tokens</b>), úr nýrri útgáfu á hlutdeildarfé sem samþykkt var á aukaaðalfundi þann 18/07/2024. Handhafar AWEARE Global Tokens eru kallaðir "<b>Þátttakendur</b>" eða "<b>Táknhafar</b>".</p>
b)	<p><b>Gjaldmiðill verðbréfaútgáfunnar</b></p> <p>Bandaríkjadalur ("<b>USD</b>" eða "<b>\$</b>"). Gildistími AWEARE Global Token er ótakmarkaður.</p>
c)	<p><b>Lýsing á réttindum sem fylgja verðbréfunum</b></p> <p><b>Kosningaréttur</b> AWEARE Global Tokens eru þáttökuskírteini án atkvæðagreiðslu og veita ekki þátttakanda rétt til að kjósa á, boða til og taka þátt í aðalfundi útgefanda. Ennfremur veita AWEARE Global Tokens ekki rétt til upplýsinga, rétt til skoðunar og rétt til að leggja fram umsókn. Þó er heimilt að leggja fyrir aðalfund skriflega beiðni um upplýsingar eða skoðun eða um að hefja opinbera endurskoðun.</p> <p><b>Auglýsing um boðun og samþykktir aðalfundar</b> Tilkynna þarf fundarmönnum um boðun aðalfundar ásamt dagskrárliðum og tillögugerð. Sérhver ályktun aðalfundar skal án tafar liggja frammi til sýnis fyrir þátttakendur á skrifstofu útgefanda. Þátttakendum skal tilkynnt um þetta í tilkynningu.</p> <p><b>Arðsréttur og hlutdeild í gjaldprotaskiptum</b> AWEARE Global Tokens bera fullan arðsrétt frá gildum yfirtökudegi og veita eigendum þeirra rétt á hlutdeild í gjaldproti í hlutfalli við hlutdeild þeirra í hlutafénu. Útgefandi ætlar ekki að úthluta arði í náinni framtíð. Þrátt fyrir að krafa um arð sé fyrir hendi samkvæmt samþykktum eru engar spár gerðar um framtíðarúthlutun arðs. Útgefandi hyggst endurfjárfesta hagnað í frekari vöxt og þróun félagsins.</p> <p><b>Form og verðbréfun</b> AWEARE Global Tokens verða gefin út sem tákn. Tákn eru gildisréttindi sem eru gefin út á dreifðan gagnagrunn (Blockchain) og flutt þangað. Blockchain sem notuð er í þessu skyni er Ethereum Blockchain.</p> <p><b>Útilokun áskriftar- og þáttökuréttar</b> Þar til hlutafjármarkmiði USD 50.000 er náð er forgangsréttur samkvæmt greinum 304d, 304f og 304g PCL, einkum áskriftar- og þáttökuréttur þátttakenda, undanskilinn.</p> <p><b>Framseljanleiki verðbréfanna</b> Flutningur (eins og framsal í þröngum skilningi, veðsetning, arfur) á AWEARE Global Tokens þarf samþykki stjórnar útgefanda. Framseljanleiki er því takmarkaður að vissu marki. Í öllum tilvikum er flutningur á AWEARE Global Tokens óheimil ef þau yrðu þá í vörslu einstaklings í landi þar sem AWEARE Global Tokens má ekki bjóða upp á. Flutningur í ofangreindum skilningi telst einnig</p>



		eiga sér stað ef auðkennishafi flytur búsetu sína til lands þar sem ekki er heimilt að bjóða AWEARE Global Tokens.
d)	<b>Hlutfallslegur starfsaldur verðbréfa í fjármagnsskipan útgefanda við gjaldprot</b>	Komi til gjaldprotts útgefanda bera þátttakendur ábyrgð með fjárfestu fé sínu. Farið skal með fjárfest sem eigið fé og er því hæft víkjandi.
og)	<b>Lýsing á arðgreiðslustefnu</b>	Enginn arður hefur verið greiddur til þessa. Útgefandi gerir engar hagnaðarspár eða áætlanir og því er ekki gerð lýsing á arðgreiðslustefnunni. Arður, ef einhver er, verður greiddur í USD. Útgefandi áskilur sér rétt til að greiða arð einnig í öðrum gjaldmiðli eða dulritunargjaldmiðli. Sérhver ákvörðun um að greiða út arð verður tekin í samræmi við gildandi lög og mun meðal annars ráðast af afkomu útgefanda, fjárhagsstöðu, samningsbundnum takmörkunum og eiginfjárkröfum. Í öllum tilvikum renna 5% af hreinum hagnaði til varasjóðs þar til hann hefur náð 10% af innborguðu hlutfé.
<b>3.2</b>	<b>Hvar verða viðskipti með verðbréfin?</b>	
<b>3.2.1</b>	AWEARE Global Tokens eru ekki tekin til viðskipta á skipulegum markaði. Útgefandi áskilur sér rétt til að sækja um töku til viðskipta á skipulegum verðbréfamarkaði.	
<b>3.4</b>	<b>Hverjar eru helstu áhættur sem eru sérstakar fyrir verðbréfin?</b>	
<b>3.4.1</b>	<p><b>Fjárfestaveski og einkalykiláhætta</b> Fjárfestirinn einn ber áhættuna af vali á veski eða staðsetningu einkalykils. Ef ósamhæft veski er notað eða ef einkalykillinn týnist er aðgangur að AWEARE Global Tokens venjulega ómögulegur. Afleiðingarnar, svo sem heildartap fjárfestingarinnar, verða eingöngu að bera á fjárfestinum.</p> <p><b>Áhætta á söluhæfni, lausafjárstöðu og innleiðingaráhættu</b> Það er engin viss um að fljótandi markaður muni þróast fyrir AWEARE Global Tokens. Þar af leiðandi var ekki hægt að selja AWEARE Global Tokens á eftirmarkaði, sem skapar lausafjárahættu fyrir fjárfestirinn.</p> <p><b>Óstöðugleikaáhætta</b> Það eru áhættur í tengslum við sveiflur á gengi hlutabréfa. Ef AWEARE Global Tokens yrðu seld og þau lentu í mikilli verðsveiflu til lækkunar gæti auðkennishafinn orðið fyrir tjóni, sem sumt gæti orðið verulegt, vegna sólunnar.</p> <p><b>Tap á táknum</b> Tákn geta týnst eða orðið óaðgengileg, sérstaklega ef auðkennishafi týnir viðkomandi einkalykli til að farga AWEARE Global táknum sínum eða vegna bilunar í rafveskinu sem AWEARE Global Tokens eru geymd í. Þetta gæti leitt til taps á táknum. Það er alfarið á ábyrgð táknhafa að geyma og vernda einkalykilinn sem veitir aðgang að rafveskinu á öruggan hátt. Tákn geta einnig orðið óaðgengileg ef táknhafi deyr ef hann eða hún gerði ekki ráðstafanir vegna slíkra mála. Hvorki útgefandinn né nokkur önnur stofnun eða stofnun mun geta endurheimt aðgang að veski auðkennishafa fyrir arftaka auðkennishafa. Tap einkalykla gæti ennfremur dregið úr framboði á ýmsum virkni STO og AWEARE Global Tokens. Sérstaklega gæti verið ómögulegt að gefa út AWEARE Global Tokens til áskrifenda eða gera þá framseljanlega í því tilviki sem þeir yrðu í biðstöðu um óákveðinn tíma. Ennfremur getur verið ómögulegt að greiða út arð. Að lokum er hættu á að árársarmaður geti slegið AWEARE Global Tokens fyrir heimilisföng sem ekki leggja fram, breytt staðfestingarstöðu, lagt óviðráðanlegar upphæðir til STO eða leyft árársarmanninum að afturkalla ósottar arðgreiðslur.</p> <p><b>Takmörkuð réttindi auðkennishafa</b> AWEARE Global Tokens eru þátttökuskírteini án atkvæðagreiðslu og gefa ekki auðkennishöfum rétt til að kjósa á, boða til og taka þátt í aðalfundi útgefanda. Ennfremur veita AWEARE Global Tokens ekki rétt til upplýsinga, rétt til skoðunar og rétt til að leggja fram umsókn. Aðalfundur útgefanda getur því samþykkt ályktanir sem geta haft slæm áhrif á réttindi táknhafa. Táknhafar hafa engan möguleika á að stjórna notkun ágóða af útgáfu AWEARE Global Tokens. Flutningur (eins og framsal í þröngum skilningi, veðsetning, arfur) á AWEARE Global Tokens þarf samþykki stjórnar útgefanda. Í öllum tilvikum er flutningur á AWEARE Global Tokens ekki leyfður ef þau yrðu þá í vörslu einstaklings í landi þar sem AWEARE Global Tokens má ekki bjóða upp á. Flutningur í ofangreindum skilningi telst einnig eiga sér stað ef auðkennishafi flytur búsetu sína til lands þar sem ekki er heimilt að bjóða AWEARE Global Tokens. Útilokaður er lögbundinn áskriftarréttur handhafa auðkennis ef um er að ræða hlutafjáraukningu samkvæmt þessu tilboði.</p> <p><b>Kröfur táknhafa eru víkjandi</b> Réttur auðkennishafa til að krefjast og taka við arðgreiðslum frá útgefanda er lægri en kröfur allra handhafa óvíkjandi skuldbindinga útgefanda. Við gjaldprotaskipti á útgefanda verða táknhafar aðeins greiddar ef og eftir að allar eldri skuldbindingar útgefanda hafa verið uppfylltar.</p>	
<b>4. KAFLI – LYKILUPPLÝSINGAR UM ÚTBOÐ VERÐABRÉFA TIL ALMENNINGS</b>		
<b>4.1</b>	<b>Við hvaða aðstæður og tímaáætlun get ég fjárfest í þessu öryggi?</b>	

#### Löndum þar sem verðbréfin eru boðin út

Útboðið samanstendur af almennum tilboðum í Austurríki, Belgíu, Búlgaríu, Króatíu, Kýpur, Tékklandi, Danmörku, Eistlandi, Finnlandi, Frakklandi, Þýskalandi, Grikklandi, Ungverjalandi, Íslandi, Írlandi, Ítalíu, Lettlandi, Liechtenstein, Litháen, Lúxemborg, Möltu., Holland, Noregur, Pólland, Portúgal, Rúmenía, Slóvakía, Slóvenía, Spánn, Svíþjóð, Sviss auk lokuð útboð í ákveðnum lögsagnarumdæmum utan þeirra.

#### Löndum þar sem verðbréfin eru ekki boðin

AWEARE Global Tokens útgefanda eru ekki og verða ekki skráð samkvæmt ákvæðum bandarískra verðbréfalaga frá 1933, með áorðnum breytingum, eða hjá verðbréfaeftirlitsyfirvöldum í neinu fylki í Bandaríkjunum, eða í Ástralíu, Japan eða Kanada. Samkvæmt því verða þær ekki boðnar, seldar eða afhentar almenningi beint eða óbeint, nema samkvæmt undanþágu frá skráningarskilyrðum. Sérstaklega felur þessi útboðslýsing ekki í sér eða felur í sér tilboð um að selja eða beiðni um kaup á AWEARE Global Tokens í Bandaríkjunum, Ástralíu, Japan og Kanada og má ekki dreifa henni þar. Að auki felur þessi útboðslýsing ekki í sér eða felur í sér tilboð um að selja eða beiðni um tilboð um kaup á AWEARE Global Tokens í Rússlandi, Íran eða Norður-Kóreu, Hvíta-Rússlandi, Sýrlandi eða einhverju svæði þar í landi. Og má ekki dreifa þar.

#### Boð

Áskriftarferlið fyrir AWEARE Global Tokens fer fram á netinu kl <https://kyc.awearetech.li/> (það "Mælaborð").

#### Tilboðstímabil

Tímabilið sem fjárfestar geta lagt fram kauptilboð sín á AWEARE Global Tokens á að hefjast á þeim degi sem lýsingin er samþykkt og lýkur einu ári síðar („Tilboðstímabil“). Á síðasta degi tilboðstímabilsins er hægt að gera tilboð til klukkan 12:00 á hádegi að Liechtensteintíma.

#### Tilboðsverð

Tilboðsverð eins AWEARE tákns er **USD 12,00** (það "Tilboðsverð").

Til að hvetja til snemma fjárfestingar eru eftirfarandi afslættir í boði:

Fyrir fjárfestingar á milli 10.000 USDC og 49.999,99 USDC munu fjárfestar fá 10% afslátt, sem gerir verðið á AWEARE Token USD 10,80.

Fyrir fjárfestingar upp á 50.000 USDC eða meira, munu fjárfestar fá 15% afslátt, sem gerir verð á AWEARE Token USD 10,20.

#### Framboð á afslætti

Ofangreindir afslættir eru í boði þar til eitt af eftirfarandi kemur upp, hvort sem kemur á undan:

- ná heildarfjárfestingarmagni upp á **5.000.000 USDC**, eða
- liðnir þrjú mánuðir frá upphafi tilboðs.

#### Afhending og uppgjör

Hver fjárfestir verður að ljúka áskriftarferlinu á netinu á mælaborðinu. AWEARE Global Tokens verður úthlutað utan keðju sem skrá í gagnagrunni útgefanda, sem hægt er að sjá í gegnum mælaborðið, gegn greiðslu tilboðsverðs. AWEARE Global Tokens verður úthlutað á keðju í snjallsamningnum í síðasta lagi innan tveggja mánaða eftir lok tilboðstímabilsins. Þegar heildarútboði AWEARE Global Tokens (eftir að hafa náð markmiðsþátttökufé) er lokið og útgefandi hefur ákveðið að ganga frá snjallsamningnum, verða AWEARE Global Tokens afhent í dulritunarveski fjárfestans.

#### Þynning

Þar sem lögbundinn áskriftarréttur allra þátttakenda er útilokaður ef um er að ræða hlutafjárukningu í tengslum við þetta tilboð verða þátttakendur þessa tilboðs ekki útpyntir.

#### Heildarhagnaður og áætlaður útgáfukostnaður

Heildarágóði tilboðsins yfir 1.400.000 AWEARE Global Tokens gæti numið u.þ.b. **USD 15.000.000** sem svarar til framkvæmda á sjóðsöfluninni. Áætlaður heildarkostnaður við tilboðið nemur u.þ.b **USD 1.500.000** og verður gjaldfært af ágóðanum.

#### 4.2 Hvers vegna er verið að útbúa þessa lýsingu?

a) Áætlaður hreinn ágóði af útgáfu verðbréfanna verður fyrst og fremst notaður til rannsókna og þróunar og til verndunar eignaréttinda. Það gæti verið nauðsynlegt að færa allt að 50% af úthlutaðri fjárveitingu í aðra stöðu ef þörf krefur.

#### 4.2.1

- i) 10% hækkunarkostnaður
- ii) 11% Almenn og stjórnunarlegt
- iii) 41% Rannsóknir og þróun
- iv) 17% löglegt (alþjóðleg IP vernd)
- v) 21% rútupróun, sala og markaðssetning

b) Meðal núverandi hluthafa AWEARE Technologies Inc. og Global Innovation Partners Limited eru Mahesh Reddy og Dr. Daniel Hyman. Mahesh Reddy og Dr. Daniel Hyman eru einnig stjórnarmenn og minnihlutaeigendur útgefandans.

	<p>c) Equanimity AG fær viðskiptaþóknun sem nemur 3% af heildar dulritunargjaldmiðlum og uppsöfnuðum fiat greiðslum. Marcel Füssinger, sem er einn af stjórnarmönnum útgefanda, er einnig forstjóri og eigandi Equanimity AG.</p> <p>d) <b>Heildarhagnaður og áætlaður útgáfukostnaður</b> Heildarágóði tilboðsins yfir 1.400.000 AWEARE Global Tokens gæti numið u.þ.b. <b>USD 15.000.000</b> sem svarar til framkvæmda á sjóðsöfluninni. Áætlaður heildarkostnaður við tilboðið nemur u.þ.b <b>USD 1.500.000</b> og verður gjaldfært af ágóðanum.</p> <p>e) <b>Fyrirkomulag sölutrygginga</b> Útboðið er ekki háð traustum sölutryggingarsamningi. Það er enginn samningur þar sem váttryggingafélagi er skylt að ábyrgjast óseld ták. Því er engin trygging fyrir því að allt útboðið verði sett.</p>
--	--

## XXIII. SAŽETAK PROSPEKTA

Ovaj sažetak sadrži sve elemente koji su potrebni za uključivanje u sažetak za ovu vrstu vrijednosnih papira i izdavaljea.

1. ODJELJAK – UVOD		
1.1	Naziv i ISIN vrijednosnih papira	The <b>1.400.000</b> nove potvrde o sudjelovanju javno su potvrde o sudjelovanju na nositelja bez prava glasa tvrtke AWEARE Global AG. Naziv ovih potvrda o sudjelovanju je "Globalni tokeni AWEARE". ISIN je L11363014385.
1.2	Identitet i podaci za kontakt izdavaljea, uključujući identifikator pravnog subjekta (LEI)	<b>AWEARE Global AG</b> („Izdavalje“) c/o Revalier Aktiengesellschaft Pradafant 11, 9490 Vaduz, Kneževina Tel: +423 237 63 47 E-pošta: info@awearetech.li LEI je: 391200PTNEZNXGJW1C39
1.3	Nadležno tijelo	<b>Uprava za financijsko tržište („FMA“)</b> Landstrasse 109, 9490 Vaduz, Kneževina Lihtenštajn Tel: +423 236 73 73 Fax: +423 236 73 74 Email: <a href="mailto:info@fma-li.li">info@fma-li.li</a>
1.4	Datum odobrenja prospekta	05/12/2024
1.5	Upozorenja	<p>a) Sažetak treba čitati kao uvod u ovaj Prospekt. Svaka odluka o ulaganju u vrijednosne papire trebala bi se temeljiti na razmatranju Prospekta u cjelini od strane ulagača.</p> <p>b) Investitor bi mogao izgubiti cijeli ili dio uloženog kapitala.</p> <p>c) Gdje tužba koja se odnosi na informacije sadržane u prospektu bude pokrenuta pred sudom, tužitelj ulagač bi mogao, prema nacionalnom pravu, morati snositi troškove prijevoda prospekta prije nego što se pokrene pravni postupak.</p> <p>d) Građanska odgovornost odnosi se samo na one osobe koje su podnijele sažetak uključujući bilo koji njegov prijevod, ali samo ako je sažetak obmanjujući, netočan ili nedosljedan, kada se čita zajedno s drugim dijelovima Prospekta ili ne pruža, kada se čita zajedno s ostali dijelovi Prospekta, ključne informacije kako bi se ulagateljima pomoglo pri odlučivanju o ulaganju u vrijednosne papire.</p>
ODJELJAK 2 – KLJUČNI PODACI O IZDAVATELJU		
2.1	Tko je izdavalje vrijednosnih papira?	
2.1.1	Podaci o izdavaljeju	<p>a) Pravni i komercijalni naziv Izdavaljea je "AWEARE Global AG". Izdavalje je dioničko društvo osnovano u Kneževini Lihtenštajn i podređeno zakonima Kneževine Lihtenštajn. Izdavalje ima sjedište u Vaduzu, Kneževina Lihtenštajn i registriran je u Uredu za pravosuđe / Trgovački registar Kneževine Lihtenštajn pod matičnim brojem FL-0002.714.015-4.</p>

	<p>b) Svrha Izdavatelja je razvoj i unovčavanje senzorskih tehnologija i umjetne inteligencije za autonomna vozila i druge primjene.</p> <p>c) Glavni dioničari Izdavatelja su:</p> <ul style="list-style-type: none"> <li>• Global Innovation Partners Limited, Britanski Djevičanski Otoci s većinskim dioničarima dr. Daniel Hyman, Mahesh Reddy, dr. Reginald Tang i Mark Hyman</li> </ul> <p>d) Upravni odbor Izdavatelja čine:</p> <ul style="list-style-type: none"> <li>• Dr. Daniel Hyman, Nacionalnost: Sjedinjene Američke Države, Poštanska adresa: Long Beach, Kalifornija, SAD</li> <li>• Mahesh Reddy, Nacionalnost: Sjedinjene Države, Poštanska adresa: Irvine, Kalifornija, SAD</li> <li>• Marcel Füssinger, Nacionalnost: Austrija, Poštanska adresa: 160009, Singapur</li> <li>• Revalier AG koju zastupa Reinhold Wohlwend, nacionalnost: Lihtenštajn, poštanska adresa: 9490, Vaduz, Lihtenštajn</li> </ul> <p>e) Revizor je: Lucas Tihanyi, član Liechtensteinske udruge revizora i EXPERTsuisse, Industriering 14, 9491 Ruggell, LLechtenstein</p>
--	--

**2.2 Koji su ključni financijski podaci o izdavatelju?**

Izdavatelj je osnovan 30. 11. 2023. godine upisom u trgovački registar Kneževine Lihtenštajn. Prema izvaji Upravnog odbora od 25. listopada 2023. Izdavatelj ne podliježe redovnoj reviziji i ne podliježe revizijskom pregledu. Međutim, godišnja financijska izvješća na dan 31. prosinca 2023. i međufinancijska izvješća na dan 15. srpnja 2023. revidirani su od strane revizora.

Sljedeće ključne financijske informacije pripremljene su u skladu s odredbama lihtenštajnskog Zakona o osobama i trgovačkim društvima („PCL”), posebno čl. 1024 i dalje.

**Račun dobiti i gubitka**

	31.12.2023	15.7.2024
<b>Ukupni prihod</b>	0 USD	0 USD
<b>Dobit/gubitak iz poslovanja</b>	USD -2.473,03	USD -30'150,54
<b>Neto dobit/gubitak</b>	USD -2.473,03	USD -30'150,54

**Bilanca stanja**

	31.12.2023	15.7.2024
<b>Ukupna imovina</b>	50'184,35 USD	75.244,30 USD
<b>Ukupni kapital</b>	47.526,97 USD	19.849,46 USD
<b>Neto financijski dug (dugoročni dug plus kratkoročni dug minus gotovina)</b>	0 USD	0 USD

**Izveštaj o novčanom toku**

	31.12.2023	15.7.2024
<b>Relevantni neto novčani tokovi iz poslovnih aktivnosti</b>	0 USD	0 USD
<b>Relevantni neto novčani tokovi iz investicijskih aktivnosti</b>	0 USD	0 USD
<b>Relevantni neto novčani tokovi iz financijskih aktivnosti</b>	0 USD	0 USD

Izgledi Izdavatelja nisu se značajno pogoršali od datuma međubilance na dan 15. srpnja 2024. Nije bilo značajnih promjena u financijskom položaju ili trgovačkoj poziciji Izdavatelja od datuma izvještavanja međubilance na dan 15. srpnja 2024. godine.

2.2.1

2.3	<b>Koji su ključni rizici specifični za izdavatelja?</b>	
2.3.1	<p><b>Nizak kapital</b> Svrha Izdavatelja je komercijalizacija AWEARE tehnologije. Vlasnički kapital Izdavatelja ograničen je na 50.000,00 USD, pri čemu je minimalni kapital potreban prema zakonu Lihtenštajna 50.000,00 USD. Budući da je Izdavatelj osnovan 30.11.2023., nikakvi značajni povijesni financijski podaci ili ključne brojke, osim povijesnih financijskih informacija navedenih u odjeljku 2.2.1 ovog sažetka, nisu dostupni za procjenu financijske situacije Izdavatelja u odnosu na do prošlih godina. Izdavatelj ne podliježe redovnoj reviziji i nema revizijski pregled. Izdavatelj nije ocijenjen od strane rejting agencije. Nizak temeljni kapital predstavlja povećani rizik za investitora, jer je funkcija jamstvenog kapitala odgovarajuće smanjena.</p> <p><b>Rizik insolventnosti</b> U slučaju otvaranja stečajnog postupka nad imovinom Izdavatelja, Izdavatelju će se privremeno ili trajno ograničiti raspolaganje imovinom Izdavatelja ili će raspolaganje imovinom Izdavatelja preuzeti sudski imenovani stečajni upravitelj. To može imati negativan utjecaj na financijski položaj i poslovanje Izdavatelja. Ovaj se slučaj može dogoditi čak i ako su zahtjevi za stečaj netočno podneseni. U slučaju nelikvidnosti Izdavatelja, Sudionici odgovaraju svojim ulozanim kapitalom. Uloženi kapital treba tretirati kao vlasnički kapital i stoga je kvalificirano podređen.</p> <p><b>Financiranje poslovanja</b> Ne postoji minimalni kapital koji treba prikupiti. Nema jamstva plasmana, već postoji rizik da globalni tokeni AWEARE neće biti u potpunosti pretplaćeni (rizik plasmana). Ako Izdavatelj ne uspije pridobiti željeni volumen izdanja, Izdavatelj će moći uložiti manje. Postoji rizik od manjka kapitala za Izdavatelja. Osim toga, troškovi emisije, koji su neovisni o iznosu prikupljenog kapitala, ostaju, što će povećati omjer troškova u odnosu na ukupno prikupljeni investicijski kapital. Postoji rizik da u ovom slučaju Izdavatelj neće postići svoje namjeravane ciljeve ulaganja i da neće moći ispuniti svoje obveze prema AWEARE Global Tokenima.</p> <p><b>Menadžment, tehnologija, oslanjanje na pružatelja usluga treće strane, konkurencija i vremenski okviri razvoja</b> Jedna od ključnih prednosti Izdavatelja je njegova pronicljiva uporaba najnovije radarske tehnologije. Međutim, tehničke prednosti u industriji informacijske i komunikacijske tehnologije mogu kratko trajati. Sukladno tome, uspjeh izdanja ovisit će, djelomice, o njegovoj sposobnosti da upravlja i proširi usluge Izdavatelja i poveća svoju poslovnu korisničku bazu te stoga ostvari prihod kao odgovor na promjenjive tehnologije, zahtjeve korisnika i pružatelja usluga trećih strana i pritiske konkurencije. Neuspjeh ili kašnjenja u tome mogu negativno utjecati na uspjeh Izdavatelja.</p> <p><b>Ljudska pogreška s pametnim ugovorima</b> Izdavatelj ne preuzima nikakvu odgovornost i ne daje nikakva predstavljanja niti jamstva u pogledu funkcionalnosti projekta Izdavatelja ili bilo kojih pametnih ugovora koji se mogu programirati ili koristiti za namirenje ponude u skladu s ovim Prospektom u najširem smislu. Ulagači mogu zbog toga pretrpjeti umanjene vrijednosti ili se općenito suočiti s potpunim gubitkom. Međutim, u takvim scenarijima mogu se primijeniti pravni mehanizmi za zaštitu ulagača od gubitka.</p>	
<b>ODJELJAK 3 – KLJUČNI PODACI O VRIJEDNOSNIM PAPIRIMA</b>		
3.1	<b>Koje su glavne karakteristike vrijednosnih papira?</b>	
3.1.1	<b>Podaci o vrijednosnim papirima</b>	
a)	<b>Opis vrste i klase vrijednosnih papira</b>	The <b>1.400.000</b> nove potvrde o sudjelovanju koje Izdavatelj javno nudi su potvrde o sudjelovanju bez prava glasa na donositelja, svaka s nominalnom vrijednošću od <b>0,01 USD</b> dioničkog kapitala („Globalni tokeni AWEARE“), iz novog izdanja dioničkog kapitala riješenog na izvanrednoj glavnoj skupštini 18. srpnja 2024. Imatelji AWEARE globalnih tokena nazivaju se „Sudionici“ ili „Imatelji žetona“.
b)	<b>Valuta izdanja vrijednosnih papira</b>	Američki dolar (“USD” ili “\$”). Trajanje globalnog tokena AWEARE je neograničeno.
c)	<b>Opis prava koja proizlaze iz vrijednosnih papira</b>	<p><b>Pravo glasa</b> Globalni tokeni AWEARE su potvrde o sudjelovanju bez prava glasa i ne daju pravo sudioniku na glasovanje, sazivanje i sudjelovanje na Glavnoj skupštini Izdavatelja. Nadalje, AWEARE Global Tokeni ne daju pravo na informacije, pravo uvida i pravo podnošenja zahtjeva. Međutim, glavnoj skupštini može se podnijeti pisani zahtjev za informacijama ili inspekcijom ili za pokretanje službene revizije.</p> <p><b>Najava sazivanja i odluke Glavne skupštine</b> O sazivanju Glavne skupštine potrebno je obavijestiti sudionike zajedno s točkama dnevnog reda i prijedlozima. Svaka odluka Glavne skupštine mora bez odgode biti dostupna na uvid Sudionicima u sjedištu Izdavatelja. Sudionici će o tome biti obaviješteni u obavijesti.</p> <p><b>Pravo na dividendu i udio u prihodu od likvidacije</b></p>

		<p>Globalni tokeni AWEARE nose puna prava na dividendu od datuma valjanog stjecanja i svojim vlasnicima daju pravo na udio u prihodu od likvidacije proporcionalno njihovom sudjelovanju u sudioničkom kapitalu. Izdavatelj trenutno ne planira raspodjelu dividendi u bliskoj budućnosti. Iako prema Statutu postoji pravo na dividendu, nema predviđanja glede buduće raspodjele dividende. Izdavatelj namjerava dobit reinvestirati u daljnji rast i razvoj društva.</p> <p><b>Forma i sekuritizacija</b> Globalni tokeni AWEARE bit će izdani kao tokeni. Tokeni su vrijednosna prava koja se izdaju u decentraliziranoj bazi podataka (Blockchain) i tamo se prenose. Blockchain koji se koristi za ovu svrhu je Ethereum Blockchain.</p> <p><b>Isključenje prava pretplate i prava sudjelovanja</b> Dok se ne postigne ciljani dionički kapital od 50.000 USD, isključena su povlaštena prava prema člancima 304d, 304f i 304g ZKP-a, posebno prava upisa i prava sudjelovanja sudionika.</p> <p><b>Prenosivost vrijednosnih papira</b> Prijenos (kao što je prijenos u užem smislu, zalaganje, nasljeđivanje) AWEARE globalnih tokena zahtijeva odobrenje Upravnog odbora Izdavatelja. Prenosivost je stoga do određene mjere ograničena. U svakom slučaju, prijenos AWEARE globalnih tokena nije dopušten ako bi ih tada držala osoba u zemlji u kojoj se AWEARE globalni tokeni ne smiju nuditi. Također se smatra da se prijenos u gore navedenom smislu dogodio ako nositelj tokena preseli svoje mjesto prebivališta u zemlju u kojoj AWEARE Global Tokeni možda neće biti ponuđeni.</p>
d)	<b>Relativni senioritet vrijednosnih papira u strukturi kapitala izdavatelja u slučaju nelikvidnosti</b>	U slučaju nelikvidnosti Izdavatelja, Sudionici odgovaraju svojim uložnim kapitalom. Uloženi kapital treba tretirati kao vlasnički kapital i stoga je kvalificirano podređen.
i)	<b>Opis politike dividendi</b>	Do danas nisu isplaćene dividende. Izdavatelj ne radi nikakve prognoze ili procjene dobiti te stoga nije napravljen opis politike dividendi. Dividende, ako ih bude, bit će isplaćene u USD. Izdavatelj zadržava pravo isplate dividende i u drugoj valuti ili kriptovaluti. Svaka odluka o isplati dividendi bit će donesena u skladu s primjenjivim zakonom i ovisit će, između ostalog, o rezultatima poslovanja Izdavatelja, financijskom položaju, ugovornim ograničenjima i kapitalnim zahtjevima. U svakom slučaju, 5% neto dobiti izdvajat će se u statutarne rezerve dok ne dosegne iznos od 10% uplaćenog temeljnog kapitala.
<b>3.2</b>	<b>Gdje će se trgovati vrijednosnim papirima?</b>	
<b>3.2.1</b>	Globalni tokeni AWEARE nisu dopušteni za trgovanje na reguliranom tržištu. Izdavatelj zadržava pravo podnošenja zahtjeva za uvrštenje u trgovanje na uređenom tržištu.	
<b>3.4</b>	<b>Koji su ključni rizici koji su specifični za vrijednosne papire?</b>	
<b>3.4.1</b>	<p><b>Novčanik investitora i rizik privatnog ključa</b> Investitor sam snosi rizik odabira novčanika ili lokacije privatnog ključa. Ako se koristi nekompatibilni novčanik ili ako se privatni ključ izgubi, pristup globalnim tokenima AWEARE obično je nemoguć. Posljedice, poput potpunog gubitka investicije, mora snositi isključivo investitor.</p> <p><b>Rizik prodajnosti, likvidnosti i rizik realizacije</b> Nema sigurnosti da će se razviti likvidno tržište za globalne tokene AWEARE. Kao rezultat toga, globalni tokeni AWEARE nisu se mogli prodati na sekundarnom tržištu, stvarajući rizik likvidnosti za ulagača.</p> <p><b>Rizik volatilnosti</b> Postoje rizici vezani uz volatilnost cijene dionice. Ako bi se globalni tokeni AWEARE prodali i ako bi bili uhvaćeni u oštroj silaznoj fluktuaciji cijene, vlasnik tokena bi mogao pretrpjeti gubitke, od kojih bi neki mogli biti znatni, kao rezultat prodaje.</p> <p><b>Gubitak tokena</b> Tokeni se mogu izgubiti ili postati nedostupni, osobito ako nositelj tokena izgubi odgovarajući privatni ključ za raspolaganje svojim AWEARE globalnim tokenima ili zbog neispravnog rada e-novčanika u kojem su AWEARE globalni tokeni pohranjeni. To bi moglo dovesti do gubitka tokena. Isključiva je odgovornost vlasnika tokena da sigurno pohrane i zaštite privatni ključ koji omogućuje pristup e-novčaniku. Tokeni mogu postati nedostupni i u slučaju smrti vlasnika tokena ako on ili ona nisu napravili pripreme za takve slučajeve. Ni Izdavatelj niti bilo koje drugo tijelo ili institucija neće biti u mogućnosti obnoviti pristup novčaniku nositelja tokena za nasljednike nositelja tokena. Gubitak privatnih ključeva mogao bi dodatno smanjiti dostupnost različitih funkcionalnosti STO i AWEARE globalnih tokena. Konkretno, može biti nemoguće izdati globalne tokene AWEARE pretplatnicima ili ih učiniti prenosivima, u kojem bi slučaju ostali pauzirani na neodređeno vrijeme. Nadalje, može biti nemoguće izvršiti isplatu dividende. Naposljetku, postoji rizik da bi napadač mogao iskovati AWEARE globalne tokene za adrese koje</p>	

	<p>ne doprinose, promijeniti status potvrde, doprinijeti nekontrolirane iznose STO-u ili dopustiti napadaču da povuče isplate dividendi koje nisu zatražene.</p> <p><b>Ograničena prava nositelja tokena</b> Globalni tokeni AWEARE su potvrde o sudjelovanju bez prava glasa i ne daju pravo Imateljima tokena da glasaju, sazivaju i sudjeluju na Glavnoj skupštini Izdavatelja. Nadalje, AWEARE Global Tokeni ne daju pravo na informacije, pravo uvida i pravo podnošenja zahtjeva. Glavna skupština Izdavatelja stoga može usvojiti odluke koje mogu negativno utjecati na prava vlasnika tokena. Imatelji tokena nemaju mogućnost kontrolirati korištenje prihoda od izdavanja AWEARE globalnih tokena. Prijenos (kao što je prijenos u užem smislu, zalaganje, nasljeđivanje) AWEARE globalnih tokena zahtijeva odobrenje Upravnog odbora Izdavatelja. U svakom slučaju, prijenos AWEARE globalnih tokena nije dopušten ako bi ih tada držala osoba u zemlji u kojoj se AWEARE globalni tokeni ne smiju nuditi. Također se smatra da se prijenos u gore navedenom smislu dogodio ako nositelj tokena preseli svoje mjesto prebivališta u zemlju u kojoj AWEARE Global Tokeni možda neće biti ponuđeni. Zakonsko pravo na upis Imatelja tokena u slučaju povećanja kapitala prema ovoj ponudi je isključeno.</p> <p><b>Potraživanja vlasnika tokena su podređena</b> Prava Imatelja tokena da zahtijevaju i primaju isplate dividende od Izdavatelja niža su od potraživanja svih imatelja nepodređenih obveza Izdavatelja. U likvidaciji Izdavatelja, Imateljima tokena bit će isplaćeno samo ako i nakon što su podmirene sve starije obveze Izdavatelja.</p>
<b>ODJELJAK 4 – KLJUČNE INFORMACIJE O PONUDI VRIJEDNOSNIH PAPIRA JAVNOSTI</b>	
4.1	<b>Pod kojim uvjetima i vremenskim rokovima mogu ulagati u ovaj vrijednosni papir?</b>
<p><b>Zemlje u kojima se nude vrijednosni papiri</b> Ponuda se sastoji od javnih ponuda u Austriji, Belgiji, Bugarskoj, Hrvatskoj, Cipru, Češkoj, Danskoj, Estoniji, Finskoj, Francuskoj, Njemačkoj, Grčkoj, Mađarskoj, Islandu, Irskoj, Italiji, Latviji, Lihtenštajnu, Litvi, Luksemburgu, Malti, Nizozemskoj, Norveškoj, Poljskoj, Portugalu, Rumunjskoj, Slovačkoj, Sloveniji, Španjolskoj, Švedskoj, Švicarskoj kao i privatni smještaji u određenim jurisdikcijama izvan njih.</p> <p><b>Zemlje u kojima se vrijednosni papiri ne nude</b> Globalni tokeni AWEARE Izdavatelja nisu i neće biti registrirani prema odredbama Zakona o vrijednosnim papirima Sjedinjenih Država iz 1933., s izmjenama i dopunama, ili kod regulatornih tijela za vrijednosne papire bilo koje države Sjedinjenih Američkih Država, ili u Australiji, Japanu ili Kanadi. Sukladno tome, neće se nuditi, prodavati ili isporučivati izravno ili neizravno javnosti, osim u skladu s izuzećem od zahtjeva za registraciju. Konkretno, ovaj Prospekt ne predstavlja niti predstavlja ponudu za prodaju ili traženje ponude za kupnju globalnih tokena AWEARE u Sjedinjenim Američkim Državama, Australiji, Japanu i Kanadi i ne smije se tamo distribuirati. Osim toga, ovaj Prospekt ne predstavlja niti predstavlja ponudu za prodaju ili traženje ponude za kupnju globalnih tokena AWEARE u Rusiji, Iranu ili Sjevernoj Koreji, Bjelorusiji, Siriji ili bilo kojem njihovom teritoriju. I ne smiju se tamo distribuirati.</p> <p><b>Nadmetanje</b> Proces pretplate za AWEARE Global Tokens odvijat će se online na adresi <a href="https://kyc.awearetech.li/">https://kyc.awearetech.li/</a> ("Nadzorna ploča").</p> <p><b>Razdoblje ponude</b> Razdoblje tijekom kojeg ulagači mogu podnijeti svoje ponude za kupnju AWEARE globalnih tokena počinje na dan odobrenja Prospekta i završava godinu dana kasnije ("Razdoblje ponude"). Posljednjeg dana Razdoblja ponude, ponude se mogu davati do 12:00 u podne po lihtenštajnskom vremenu.</p> <p><b>Cijena ponude</b> Cijena ponude jednog AWEARE tokena je <b>12,00 USD</b> ("Cijena ponude").</p> <p>Za poticanje ranog ulaganja dostupni su sljedeći popusti:</p> <p>Za ulaganja između 10.000 USDC i 49.999,99 USDC, ulagači će dobiti popust od 10%, čineći cijenu po AWEARE tokenu 10,80 USD.</p> <p>Za ulaganja od 50.000 USDC ili više, ulagači će dobiti popust od 15%, čineći cijenu po AWEARE tokenu 10,20 USD.</p> <p><b>Dostupnost popusta</b> Gore navedeni popusti su dostupni <b>dok se ne dogodi jedno od sljedećeg, što god nastupi prije:</b></p> <ul style="list-style-type: none"> <li>• dostižući ukupni volumen ulaganja od 5.000.000 USDC, ili</li> <li>• isteka tri mjeseca od početka ponude.</li> </ul> <p><b>Isporuka i obračun</b> Svaki investitor mora dovršiti online postupak pretplate na nadzornoj ploči. Globalni tokeni AWEARE bit će dodijeljeni izvan lanca kao zapis u bazi podataka Izdavatelja, koji se može vidjeti putem Nadzorne ploče, uz plaćanje Ponuđene cijene. Globalni tokeni AWEARE bit će dodijeljeni u lancu u pametnom ugovoru najkasnije u roku od dva mjeseca nakon završetka Razdoblja ponude. Nakon što ukupna ponuda AWEARE globalnih tokena (nakon postizanja ciljanog participacijskog kapitala) završi i Izdavatelj odluči finalizirati pametni ugovor, AWEARE globalni tokeni bit će isporučeni u investitorov kripto novčanik.</p>	

<p><b>Razrjeđivanje</b> Budući da je zakonsko pravo upisa svih sudionika isključeno u slučaju povećanja kapitala u kontekstu ove ponude, sudionici ove ponude neće biti razrijeđeni.</p> <p><b>Ukupni neto prihod i procijenjeni troškovi izdavanja</b> Ukupni neto prihod od ponude preko 1.400.000 AWEARE globalnih tokena može iznositi otprilike <b>15 000 000 USD</b> koji odgovara provedbi prikupljanja sredstava. Očekivani ukupni troškovi ponude iznose cca <b>1 500 000 USD</b> a naplatit će se iz prihoda.</p>	
<b>4.2</b>	<b>Zašto se izrađuje ovaj prospekt?</b>
<b>4.2.1</b>	<p>a) Procijenjeni neto prihod od izdavanja vrijednosnih papira prvenstveno će se koristiti za istraživanje i razvoj te zaštitu intelektualnog vlasništva. Možda će biti potrebno prebaciti do 50% dodijeljenog proračuna na drugu poziciju ako je potrebno.</p> <p style="margin-left: 40px;">i) 10% troškova povećanja ii) 11% Opće i administrativno iii) 41% Istraživanje i razvoj iv) 17% legalno (Globalna IP zaštita) v) 21% Bus Dev, prodaja i marketing</p> <p>b) Trenutačni dioničari AWEARE Technologies Inc. i Global Innovation Partners Limited su Mahesh Reddy i dr. Daniel Hyman. Mahesh Reddy i dr. Daniel Hyman također su direktori i manjinski dioničari Izdavatelja.</p> <p>c) Equanimity AG prima naknadu za transakciju od 3% od ukupnih akumuliranih plaćanja u kripto valutama i fiat. Marcel Füssinger, koji je jedan od direktora Izdavatelja, također je direktor i vlasnik Equanimity AG.</p> <p>d) <b>Ukupni neto prihod i procijenjeni troškovi izdavanja</b> Ukupni neto prihod od ponude preko 1.400.000 AWEARE globalnih tokena može iznositi otprilike <b>15 000 000 USD</b> koji odgovara provedbi prikupljanja sredstava. Očekivani ukupni troškovi ponude iznose cca <b>1 500 000 USD</b> a naplatit će se iz prihoda.</p> <p>e) <b>Ugovori o osiguranju</b> Ponuda ne podliježe čvrstom ugovoru o preuzimanju. Ne postoji ugovor prema kojem je pokrovitelj obvezan preuzeti neprodane tokene. Stoga nema jamstva da će cijela ponuda biti postavljena.</p>

## XXIV. PROSPEKTÜSÜN ÖZETİ

Bu özet, bu tür menkul kıymetler ve ihraççı için bir özetinde bulunması gereken tüm unsurları içerir.

BÖLÜM 1 - GİRİŞ		
<b>1.1</b>	<b>Menkul kıymetlerin adı ve ISIN kodu</b>	Halka arz edilen <b>1.400.000</b> yeni katılım sertifikası, AWEARE Global AG'nin oy hakkı olmayan hamiline yazılı katılım sertifikalarıdır. Bu katılım sertifikalarının adı " <b>AWEARE Global Tokens</b> "tir. ISIN kodu LI1363014385'tir.
<b>1.2</b>	<b>Tüzel kişi kimlik kodu (LEI) dahil olmak üzere ihraççının kimlik ve iletişim bilgileri</b>	<b>AWEARE Global AG ("İhraççı")</b> c/o Revalier Aktiengesellschaft Pradafant 11, 9490 Vaduz, Prenslük Tel: +423 237 63 47 E-posta: info@awearetech.li LEI numarası: 391200PTNEZNXGJW1C39
<b>1.3</b>	<b>Yetkili Makam</b>	<b>Finansal Piyasa Otoritesi ("FMA")</b> Landstrasse 109, 9490 Vaduz, Lihtenştayn Prenslüğü Tel: +423 236 73 73 Faks: +423 236 73 74 E-posta: <a href="mailto:info@fma-li.li">info@fma-li.li</a>
<b>1.4</b>	<b>İzahnamenin onay tarihi</b>	05/12/2024
<b>1.5</b>	<b>Uyarılar</b>	
<b>1.5.1</b>		<p>a) Özet, bu İzahname'ye bir giriş olarak okunmalıdır. Menkul kıymetlere yatırım yapma kararı, yatırımcı tarafından Prospektüs'ün bir bütün olarak değerlendirilmesine dayanmalıdır.</p> <p>b) Yatırımcı yatırdığı sermayenin tamamını veya bir kısmını kaybedebilir.</p>



	<p>c) İzahnamede yer alan bilgilere ilişkin bir iddianın mahkemeye taşınması halinde, davacı yatırımcı, ulusal hukuk uyarınca, yasal işlemler başlatılmadan önce İzahnamenin tercüme masraflarını üstlenmek zorunda kalabilir.</p> <p>d) Hukuki sorumluluk sadece, özetin İzahname'nin diğer bölümleriyle birlikte okunduğunda yanıltıcı, yanlış veya tutarsız olması veya İzahname'nin diğer bölümleriyle birlikte okunduğunda yatırımcıların menkul kıymetlere yatırım yapma yapmamayı düşünmelerine yardımcı olacak temel bilgileri sağlamaması halinde, herhangi bir tercümesi de dahil olmak üzere özeti hazırlayan kişilere aittir.</p>																								
<b>BÖLÜM 2 - İHRAÇCI HAKKINDA TEMEL BİLGİLER</b>																									
<b>2.1</b>	<b>Menkul kıymetlerin ihraççısı kimdir?</b>																								
<b>2.1.1</b>	<b>İhraççı hakkında bilgi</b>																								
	<p>a) İhraççının yasal ve ticari unvanı "AWEARE Global AG "dir. İhraççı, Liechtenstein Prensiği'nde kurulmuş ve Liechtenstein Prensiği kanunlarına tabi bir kamu limited şirkettir. İhraççının kayıtlı ofisi Vaduz, Lihtenştayn Prensiği'ndedir ve Lihtenştayn Prensiği Adalet Ofisi / Ticaret Sicili'nde FL-0002.714.015-4 kayıt numarası ile kayıtlıdır.</p> <p>b) İhraççının amacı, otonom araçlar ve diğer uygulamalar için sensör teknolojileri ve yapay zeka geliştirmek ve bunlardan para kazanmaktır.</p> <p>c) İhraççı'nın ana hissedarları şunlardır</p> <ul style="list-style-type: none"> <li>Global Innovation Partners Limited, British Virgin Islands, çoğunluk hissedarları Dr. Daniel Hyman, Mahesh Reddy, Dr. Reginald Tang ve Mark Hyman</li> </ul> <p>d) İhraççının Yönetim Kurulu şu kişilerden oluşmaktadır:</p> <ul style="list-style-type: none"> <li>Dr. Daniel Hyman, Uyuşu: Amerika Birleşik Devletleri, Posta Adresi: Long Beach, Kaliforniya, ABD</li> <li>Mahesh Reddy, Uyuşu: Amerika Birleşik Devletleri, Posta Adresi: Irvine, Kaliforniya, ABD</li> <li>Marcel Füssinger, Uyuşu: Avusturya, Posta Adresi: 160009, Singapur</li> <li>Reinhold Wohlwend tarafından temsil edilen Revalier AG, Uyruk: Liechtenstein, Posta Adresi: 9490, Vaduz, Lihtenştayn</li> </ul> <p>e) Denetçi: Lucas Tihanyi, Liechtenstein Denetçiler Birliği Üyesi ve EXPERTsuisse, Industriering 14, 9491 Ruggell, Liechtenstein</p>																								
<b>2.2</b>	<b>İhraççıya ilişkin temel finansal bilgiler nelerdir?</b>																								
<b>2.2.1</b>	<p>İhraççı, 30/11/2023 tarihinde Lihtenştayn Prensiği ticaret siciline tescil edilerek kurulmuştur. Yönetim Kurulu'nun 25 Ekim 2023 tarihli beyanına göre, İhraççı olağan bir denetime tabi değildir ve bir denetim incelemesine tabi değildir. Ancak, 31 Aralık 2023 tarihli yıllık finansal tablolar ve 15 Temmuz 2023 tarihli ara dönem finansal tablolar Denetçi tarafından denetlenmiştir.</p> <p>Aşağıdaki temel finansal bilgiler Liechtenstein Kişiler ve Şirketler Kanunu ('PCL') hükümlerine, özellikle de Madde 1024 ve devamına uygun olarak hazırlanmıştır. 1024 ve devamı.</p> <p style="text-align: center;"><b>Gelir tablosu</b></p> <table border="1" style="width: 100%; border-collapse: collapse;"> <thead> <tr> <th></th> <th style="text-align: center;">31/12/2023</th> <th style="text-align: center;">15/07/2024</th> </tr> </thead> <tbody> <tr> <td><b>Toplam gelir</b></td> <td style="text-align: center;">0 ABD DOLARI</td> <td style="text-align: center;">0 ABD DOLARI</td> </tr> <tr> <td><b>Faaliyet kârı/zararı</b></td> <td style="text-align: center;">ABD DOLARI -2'473.03</td> <td style="text-align: center;">USD -30'150.54</td> </tr> <tr> <td><b>Net kar/zarar</b></td> <td style="text-align: center;">ABD DOLARI -2'473.03</td> <td style="text-align: center;">USD -30'150.54</td> </tr> </tbody> </table> <p style="text-align: center;"><b>Bilanço</b></p> <table border="1" style="width: 100%; border-collapse: collapse;"> <thead> <tr> <th></th> <th style="text-align: center;">31/12/2023</th> <th style="text-align: center;">15/07/2024</th> </tr> </thead> <tbody> <tr> <td><b>Toplam varlıklar</b></td> <td style="text-align: center;">50'184,35 ABD DOLARI</td> <td style="text-align: center;">75'244,30 ABD DOLARI</td> </tr> <tr> <td><b>Toplam özkaynak</b></td> <td style="text-align: center;">47,526.97 ABD DOLARI</td> <td style="text-align: center;">19'849,46 ABD DOLARI</td> </tr> <tr> <td><b>Net finansal borç (uzun vadeli borç artı kısa vadeli borç eksi nakit)</b></td> <td style="text-align: center;">0 ABD DOLARI</td> <td style="text-align: center;">0 ABD DOLARI</td> </tr> </tbody> </table>		31/12/2023	15/07/2024	<b>Toplam gelir</b>	0 ABD DOLARI	0 ABD DOLARI	<b>Faaliyet kârı/zararı</b>	ABD DOLARI -2'473.03	USD -30'150.54	<b>Net kar/zarar</b>	ABD DOLARI -2'473.03	USD -30'150.54		31/12/2023	15/07/2024	<b>Toplam varlıklar</b>	50'184,35 ABD DOLARI	75'244,30 ABD DOLARI	<b>Toplam özkaynak</b>	47,526.97 ABD DOLARI	19'849,46 ABD DOLARI	<b>Net finansal borç (uzun vadeli borç artı kısa vadeli borç eksi nakit)</b>	0 ABD DOLARI	0 ABD DOLARI
	31/12/2023	15/07/2024																							
<b>Toplam gelir</b>	0 ABD DOLARI	0 ABD DOLARI																							
<b>Faaliyet kârı/zararı</b>	ABD DOLARI -2'473.03	USD -30'150.54																							
<b>Net kar/zarar</b>	ABD DOLARI -2'473.03	USD -30'150.54																							
	31/12/2023	15/07/2024																							
<b>Toplam varlıklar</b>	50'184,35 ABD DOLARI	75'244,30 ABD DOLARI																							
<b>Toplam özkaynak</b>	47,526.97 ABD DOLARI	19'849,46 ABD DOLARI																							
<b>Net finansal borç (uzun vadeli borç artı kısa vadeli borç eksi nakit)</b>	0 ABD DOLARI	0 ABD DOLARI																							

<b>Nakit akış tablosu</b>		
	<b>31/12/2023</b>	<b>15/07/2024</b>
<b>İşletme faaliyetlerinden elde edilen ilgili net nakit akışları</b>	0 ABD DOLARI	0 ABD DOLARI
<b>Yatırım faaliyetlerinden kaynaklanan ilgili net nakit akışları</b>	0 ABD DOLARI	0 ABD DOLARI
<b>Finansman faaliyetlerinden kaynaklanan ilgili net nakit akışları</b>	0 ABD DOLARI	0 ABD DOLARI
<p>İhraççı'nın görünümü 15/07/2024 tarihli ara bilanço tarihinden bu yana önemli ölçüde kötüleşmemiştir. 15/07/2024 tarihli ara bilançonun raporlama tarihinden bu yana İhraççı'nın finansal durumunda veya ticari pozisyonunda önemli bir değişiklik olmamıştır.</p>		
<b>2.3</b>	<b>İhraççıya özgü temel riskler nelerdir?</b>	
<b>2.3.1</b>	<p><b>Düşük sermaye</b> İhraççının amacı AWEARE'in teknolojisini ticarileştirilmesidir. İhraççının öz sermayesi 50.000,00 ABD Doları ile sınırlı olup, Lihtenştayn hukuku uyarınca gerekli olan asgari sermaye 50.000,00 ABD Dolarıdır. İhraççı 30/11/2023 tarihinde kurulduğundan, İhraççı'nın geçmiş yıllara ilişkin finansal durumunu değerlendirmek için işbu özetin 2.2.1 bölümünde atıfta bulunulan tarihsel finansal bilgiler dışında önemli bir tarihsel finansal veri veya kilit rakam mevcut değildir. İhraççı olağan bir denetime tabi değildir ve bir denetim incelemesine sahip değildir. İhraççı bir derecelendirme kuruluşu tarafından değerlendirilmemiştir. Düşük öz sermaye, yatırımcı için artan bir riski temsil eder, çünkü sorumlu sermaye işlevi buna bağlı olarak azalır.</p> <p><b>İflas riski</b> İhraççının varlıkları üzerinde iflas davası açılması durumunda, İhraççının varlıklarının elden çıkarılması geçici veya kalıcı olarak sınırlandırılacak veya İhraççının varlıklarının elden çıkarılması mahkemece atanmış bir iflas yöneticisi tarafından devralınacaktır. Bu durum, İhraççı'nın mali durumu ve ticari faaliyetleri üzerinde olumsuz bir etkiye sahip olabilir. Bu durum, iflas başvuruları yanlış yapılmış olsa dahi meydana gelebilir. İhraççının iflası durumunda, Katılımcılar yatırdıkları sermayeleri ile sorumludurlar. Yatırılan sermaye özkaynak olarak değerlendirilecek ve bu nedenle nitelikli olarak sermaye benzeri olacaktır.</p> <p><b>İşletme finansmanı</b> Toplanması gereken asgari bir sermaye yoktur. Yerleştirme garantisi yoktur, bunun yerine AWEARE Global Token'larına tam olarak abone olunmaması riski vardır (yerleştirme riski). İhraççı istenen ihraç hacmini talep etmeyi başaramazsa, İhraççı daha az yatırım yapabilecektir. İhraççı için sermaye açığı riski bulunmaktadır. Buna ek olarak, toplanan sermaye miktarından bağımsız olan emisyon maliyetleri devam edecek ve bu da toplanan toplam yatırım sermayesine ilişkin gider oranını artıracaktır. Bu durumda, İhraççının amaçlanan yatırım hedeflerine ulaşmaması ve AWEARE Global Tokenları kapsamındaki yükümlülüklerini yerine getirememesi riski bulunmaktadır.</p> <p><b>Yönetim, teknoloji, üçüncü taraf hizmet sağlayıcılara bağımlılık, rekabet ve geliştirme zaman dilimleri</b> İhraççının en güçlü yönlerinden biri, en son radar teknolojisini akıllıca kullanmasıdır. Ancak bilgi ve iletişim teknolojisi sektöründeki teknik avantajlar kısa ömürlü olabilir. Buna göre, İhraççı'nın başarısı, kısmen, İhraççı'nın hizmetlerini yönetme ve genişletme ve işletmesinin kullanıcı tabanını büyütmeye ve dolayısıyla değişen teknolojilere, kullanıcı ve üçüncü taraf hizmet sağlayıcıların taleplerine ve rekabetçi baskılara yanıt olarak gelir elde etme becerisine bağlı olacaktır. Bu konudaki başarısızlık veya gecikmeler İhraççı'nın başarısını olumsuz etkileyebilir.</p> <p><b>Akıllı sözleşmelerde insan hatası</b> İhraççı, İhraççı projesinin veya en geniş anlamda bu İzahname uyarınca arzın gerçekleştirilmesi için programlanabilecek veya kullanılacak herhangi bir akıllı sözleşmenin işlevselliği konusunda hiçbir sorumluluk kabul etmez ve hiçbir beyan veya garanti vermez. Yatırımcılar sonuç olarak değer kaybına uğrayabilir veya genellikle tamamen zarar edebilir. Ancak, bu tür senaryolarda, yatırımcıyı zarardan korumak için yasal mekanizmalar uygulanabilir.</p>	
<b>BÖLÜM 3 - MENKUL KIYMETLERE İLİŞKİN TEMEL BİLGİLER</b>		
<b>3.1</b>	<b>Menkul kıymetlerin temel özellikleri nelerdir?</b>	
<b>3.1.1</b>	<b>Menkul kıymetler hakkında bilgi</b>	
<b>a)</b>	<b>Menkul kıymetlerin türü ve sınıfının tanımı</b>	İhraççı tarafından halka arz edilen <b>1.400.000</b> yeni katılım sertifikası, 18/07/2024 tarihinde olağanüstü bir Genel Kurul tarafından kararlaştırılan yeni bir katılım sermayesi ihracından elde edilen, her biri <b>0,01 USD</b> nominal değerinde oy hakkı olmayan hamiline yazılı katılım sertifikalarıdır ("AWEARE Global Tokenları"). AWEARE Global Token sahiplerine " <b>Katılımcılar</b> " veya " <b>Token Sahipleri</b> " denir.

b)	<b>Menkul kıymet ihracının para birimi</b>	Birleşik Devletler Doları ("USD" veya "\$"). AWEARE Global Token'ın süresi sınırsızdır.
c)	<b>Menkul kıymetlere bağlı hakların tanımı</b>	<p><b>Oy kullanma hakkı</b> AWEARE Global Tokenları oy hakkı olmayan katılım sertifikalarıdır ve Katılımcıya İhraççının Genel Kurulunda oy kullanma, toplantı düzenleme ve toplantıya katılma hakkı vermez. Ayrıca, AWEARE Global Tokenları bilgi edinme hakkı, inceleme hakkı ve başvuru yapma hakkı vermez. Ancak, Genel Kurul'a bilgi veya inceleme veya resmi bir denetim başlatılması için yazılı bir talep sunulabilir.</p> <p><b>Genel Kurul'un toplanması ve kararlarının duyurulması</b> Katılımcılar, gündemdeki maddeler ve önerilerle birlikte Genel Kurul'un toplandığı konusunda bilgilendirilmelidir. Genel Kurul'un her kararı, gecikmeksizin İhraççının kayıtlı ofisinde Katılımcılar tarafından incelenmek üzere hazır bulundurulmalıdır. Katılımcılar bu konuda bildirimde bilgilendirilecektir.</p> <p><b>Temettü hakkı ve tasfiye gelirlerinden pay</b> AWEARE Global Tokenları, geçerli edinim tarihinden itibaren tam temettü hakları taşıyor ve sahiplerine tasfiye gelirlerinden iştirak sermayesine katılımları oranında pay alma hakkı verir. Esas Sözleşme uyarınca temettü talebi mevcut olmakla birlikte, gelecekteki temettü dağıtımlarına ilişkin herhangi bir öngöründe bulunulmamaktadır. İhraççı, şirketin daha da büyümesi ve gelişmesi için karları yeniden yatırıma dönüştürmeyi amaçlamaktadır.</p> <p><b>Form ve sekürütizasyon</b> AWEARE Global Tokenları token olarak çıkarılacaktır. Jetonlar, merkezi olmayan bir veritabanında (Blockchain) yayınlanan ve oraya aktarılan değer haklarıdır. Bu amaçla kullanılan Blok Zinciri Ethereum Blok Zinciridir.</p> <p><b>Abonelik haklarının ve katılım haklarının hariç tutulması</b> Hedef katılım sermayesi olan 50.000 ABD Dolarına ulaşılıncaya kadar, PCL Madde 304d, 304f ve 304g uyarınca imtiyazlı haklar, özellikle de Katılımcıların rüçhan hakları ve katılım hakları hariç tutulur.</p> <p><b>Menkul kıymetlerin devredilebilirliği</b> AWEARE Global Tokenlarının devri (dar anlamda devir, rehin, miras gibi), İhraççının Yönetim Kurulunun onayını gerektirir. Bu nedenle devredilebilirlik belirli bir ölçüde sınırlıdır. Her durumda, AWEARE Global Tokenlarının AWEARE Global Tokenlarının arz edilemeyeceği bir ülkedeki bir kişi tarafından elde tutulması durumunda AWEARE Global Tokenlarının devrine izin verilmez. Bir Token sahibinin ikamet yerini AWEARE Global Tokenlarının sunulamayacağı bir ülkeye taşıması durumunda da yukarıdaki anlamda bir transferin gerçekleştiği kabul edilir.</p>
d)	<b>İflas durumunda ihraççının sermaye yapısında menkul kıymetlerin göreceli kıdemi</b>	İhraççının iflası durumunda, Katılımcılar yatırdıkları sermaye ile sorumludurlar. Yatırılan sermaye özkaynak olarak değerlendirilecek ve bu nedenle nitelikli olarak sermaye benzeri olacaktır.
e)	<b>Temettü politikasının açıklaması</b>	Bugüne kadar herhangi bir temettü ödemesi yapılmamıştır. İhraççı herhangi bir kar tahmini veya öngörüsü yapmamaktadır ve bu nedenle temettü politikasına ilişkin bir açıklama yapılmamıştır. Temettüleri, eğer varsa, ABD Doları cinsinden ödenecektir. İhraççı, temettüleri başka bir para birimi veya kripto para birimi cinsinden de ödeme hakkını saklı tutar. Temettü ödemesine ilişkin herhangi bir karar, yürürlükteki yasalara uygun olarak alınacak olup, diğer hususların yanı sıra İhraççının faaliyet sonuçlarına, finansal durumuna, sözleşmeye bağlı kısıtlamalara ve sermaye gereksinimlerine bağlı olacaktır. Her durumda, net kârın %5'i, ödenmiş sermayenin %10'una ulaşana kadar yasal yedeklere tahsis edilecektir.
<b>3.2</b>	<b>Menkul kıymetler nerede işlem görecek?</b>	
<b>3.2.1</b>		AWEARE Global Tokenları, düzenlenmiş bir piyasada işlem görmeye kabul edilmemiştir. İhraççı, düzenlenmiş bir piyasada ticarete kabul için başvurma hakkını saklı tutar.
<b>3.4</b>	<b>Menkul kıymetlere özgü temel riskler nelerdir?</b>	
<b>3.4.1</b>	<b>Yatırımcı Cüzdanı ve Özel Anahtar Riski</b> Yatırımcı, cüzdan seçiminin veya özel anahtarın konumunun riskini tek başına taşır. Uyumsuz bir cüzdan kullanılırsa veya özel anahtar kaybedilirse, AWEARE Global Tokenlarına erişim normalde imkansızdır. Yatırımın tamamen kaybedilmesi gibi sonuçlar yalnızca yatırımcı tarafından karşılanmalıdır.	
	<b>Satılabilirlik, likidite ve gerçekleştirme riski</b> AWEARE Global Tokenları için likit bir piyasanın gelişeceğine dair bir kesinlik yoktur. Sonuç olarak, AWEARE Global Tokenları ikincil bir piyasada satılamaz ve yatırımcı için likidite riski oluşturur.	

	<p><b>Volatilite riski</b> Hisse fiyatının oynaklığı ile bağlantılı riskler vardır. AWEARE Global Tokenları satılırsa ve keskin bir aşağı yönlü fiyat dalgalanmasına yakalanırlarsa, Token sahibi satış sonucunda bazıları önemli olabilecek kayıplara uğrayabilir.</p> <p><b>Jeton Kaybı</b> Tokenlar, özellikle Token sahibinin AWEARE Global Tokenlarını elden çıkarmak için ilgili özel anahtarı kaybetmesi veya AWEARE Global Tokenlarının saklandığı e-cüzdanın arızalanması nedeniyle kaybolabilir veya erişilemez hale gelebilir. Bu durum Tokenların kaybına neden olabilir. E-cüzdana erişim sağlayan özel anahtarı güvenli bir şekilde saklamak ve korumak tamamen Token Sahiplerinin sorumluluğundadır. Tokenlar, bu tür durumlar için düzenleme yapmamış olması halinde bir Token Sahibinin ölümü durumunda da erişilemez hale gelebilir. Ne İhraççı ne de başka bir kurum veya kuruluş Token Sahibinin halefleri için Token Sahibinin cüzdanına erişimi yeniden sağlayamayacaktır. Özel anahtarların kaybı ayrıca STO'nun ve AWEARE Global Tokenlarının çeşitli işlevlerinin kullanılabilirliğini azaltabilir. Özellikle, AWEARE Global Tokenlarını abonelere vermek veya bunları devredilebilir hale getirmek imkansız olabilir, bu durumda süresiz olarak duraklatılmış kalırlar. Ayrıca temettü ödemeleri yapmak da imkansız olabilir. Son olarak, bir saldırganın AWEARE Global Tokenlarını katkıda bulunmayan adresler için basması, onay durumunu değiştirmesi, STO'ya kontrolsüz miktarlarda katkıda bulunması veya saldırganın talep edilmemiş temettü ödemelerini çekmesine izin vermesi riski vardır.</p> <p><b>Token sahibinin sınırlı hakları</b> AWEARE Global Tokenları oy hakkı olmayan katılım sertifikalarıdır ve Token sahiplerine İhraççının Genel Kurulunda oy kullanma, toplantı düzenleme ve toplantıya katılma hakkı vermez. Ayrıca, AWEARE Global Tokenları bilgi edinme hakkı, inceleme hakkı ve başvuru yapma hakkı vermez. Bu nedenle, İhraççının Genel Kurulu, Token sahiplerinin haklarını olumsuz etkileyebilecek kararlar alabilir. Token sahiplerinin AWEARE Global Tokenlarının ihracından elde edilen gelirlerin kullanımını kontrol etme imkanı yoktur. AWEARE Global Tokenlarının devri (dar anlamda devir, rehin, miras gibi), İhraççının Yönetim Kurulunun onayını gerektirir. Her durumda, AWEARE Global Tokenlarının AWEARE Global Tokenlarının arz edilemeyeceği bir ülkedeki bir kişi tarafından elde tutulması durumunda AWEARE Global Tokenlarının devrine izin verilmez. Bir Token sahibinin ikamet yerini AWEARE Global Tokenlarının sunulmayacağı bir ülkeye taşıması durumunda da yukarıdaki anlamda bir transferin gerçekleştiği kabul edilir. Bu teklif kapsamında bir sermaye artırımında Token sahiplerinin yasal abonelik hakkı hariç tutulur.</p> <p>Token sahiplerinin talepleri <b>ikincildir</b> Token sahiplerinin İhraççıdan temettü ödemeleri talep etme ve alma hakları, İhraççının ikincil olmayan yükümlülüklerinin tüm sahiplerinin taleplerine göre ikincildir. İhraççının tasfiyesinde, Token Sahiplerine yalnızca İhraççının tüm üst düzey yükümlülükleri yerine getirildikten sonra ödeme yapılacaktır.</p>
--	---

#### BÖLÜM 4 - MENKUL KIYMETLERİN HALKA ARZINA İLİŞKİN TEMEL BİLGİLER

##### 4.1 Bu menkul kıymete hangi koşullar ve zaman çizelgesi altında yatırım yapabilirim?

###### Menkul kıymetlerin arz edildiği ülkeler

Avusturya, Belçika, Bulgaristan, Hırvatistan, Kıbrıs, Çek Cumhuriyeti, Danimarka, Estonya, Finlandiya, Fransa, Almanya, Yunanistan, Macaristan, İzlanda, İrlanda, İtalya, Letonya, Lihtenştayn, Litvanya, Lüksemburg, Malta, Hollanda, Norveç, Polonya, Portekiz, Romanya, Slovakya, Slovenya, İspanya, İsveç, İsviçre'de halka arz ve bunların dışındaki bazı ülkelerde özel plasmanlardan oluşmaktadır.

###### Menkul kıymetlerin arz edilmediği ülkeler

İhraççının AWEARE Global Tokenları, değiştirildiği şekliyle 1933 tarihli Amerika Birleşik Devletleri Menkul Kıymetler Kanunu hükümleri kapsamında veya Amerika Birleşik Devletleri'nin herhangi bir eyaletinin veya Avustralya, Japonya veya Kanada'nın menkul kıymetler düzenleme makamları nezdinde kayıtlı değildir ve kayıtlı olmayacaktır. Buna göre, tescil gerekliliklerinden muafiyet dışında, doğrudan veya dolaylı olarak halka arz edilmeyecek, satılmayacak veya teslim edilmeyecektir. Özellikle, bu İzahname Amerika Birleşik Devletleri, Avustralya, Japonya ve Kanada'da AWEARE Global Tokenlarını satmak için bir teklif veya satın almak için bir teklif talebi oluşturamaz veya teşkil etmez ve buralarda dağıtılamaz. Ayrıca, bu Prospektüs Rusya, İran veya Kuzey Kore, Belarus, Suriye veya bunların herhangi bir bölgesinde AWEARE Global Tokenlarının satılması veya satın alınması için bir teklif teşkil etmez. Ve buralarda dağıtılamaz.

###### Teklif Verme

AWEARE Global Tokenları için abonelik süreci <https://kyc.awaretech.li/> adresinde ("Pano") çevrimiçi olarak gerçekleştirilecektir.

###### Teklif Dönemi

Yatırımcıların AWEARE Global Tokenları için satın alma tekliflerini sunabilecekleri dönem, İzahnamenin onaylandığı tarihte başlayacak ve bir yıl sonra sona erecektir ("Teklif Dönemi"). Teklif Döneminin son gününde, Lihtenştayn saatiyle öğlen 12:00'ye kadar teklif verilebilir.

###### Teklif Fiyatı

Bir AWEARE Token'ın teklif fiyatı **12,00 USD**'dir ("Teklif Fiyatı").

Erken yatırımı teşvik etmek için aşağıdaki indirimler mevcuttur:

Yatırımcılar, 10.000 USDC ile 49.999,99 USDC arasındaki yatırımlar için %10 indirim alacak ve AWEARE Token başına fiyat 10,80 USD olacaktır.

50.000 USDC veya daha fazla yatırımlar için yatırımcılar %15 indirim alacak ve AWEARE Token başına fiyat 10,20 USD olacaktır.

#### İndirimlerin kullanılabilirliği

Yukarıdaki indirimler, **hangisi önce gelirse, aşağıdakilerden biri gerçekleşene kadar** kullanılabilir:

- **toplam 5.000.000 USDC yatırım hacmine ulaşmak** veya
- **teklifin başlangıcından itibaren üç ay içinde sona erecektir.**

#### Teslimat ve hesaplama

Her yatırımcı, Gösterge Panosundaki çevrimiçi abonelik sürecini tamamlamalıdır. AWEARE Global Tokenları, Teklif Fiyatının ödenmesi karşılığında, İhraççının veritabanında, Gösterge Tablosu aracılığıyla görülebilen bir kayıt olarak zincir dışı tahsis edilecektir. AWEARE Global Tokenları, Teklif Döneminin bitiminden sonra en geç iki ay içinde Akıllı Sözleşmede zincir üzerinde tahsis edilecektir. AWEARE Global Tokenlarının toplam arzı (hedef katılım sermayesine ulaşıldıktan sonra) sona erdiğinde ve İhraççı Akıllı Sözleşmeyi tamamlamaya karar verdiğinde, AWEARE Global Tokenları yatırımcının kripto cüzdanına teslim edilecektir.

#### Seyreltme

Bu teklif bağlamında bir sermaye artırımını yapılması durumunda tüm Katılımcıların yasal rüçhan hakkı hariç tutulduğundan, bu teklifin Katılımcıları seyretilmeyecektir.

#### Toplam net hasılat ve tahmini ihraç maliyetleri

Teklifin 1.400.000 AWEARE Global Token üzerinden toplam net geliri, fon artırımının uygulanmasına karşılık gelen yaklaşık **15.000.000 USD** tutarında olabilir. Teklifin beklenen toplam maliyeti yaklaşık **1.500.000 ABD Doları** tutarındadır ve elde edilen gelirden tahsil edilecektir.

<b>4.2</b>	<b>Bu prospektüs neden hazırlanıyor?</b>
<b>4.2.1</b>	<p>a) Menkul kıymetlerin ihracından elde edilecek tahmini net gelir, öncelikle araştırma ve geliştirme ile fikri mülkiyetin korunması için kullanılacaktır. Gerektiğinde tahsis edilen bütçenin %50'sine kadar olan kısmının başka bir pozisyona kaydırılması gerekebilir.</p> <p>i) 10 Zam Maliyeti ii) 11% Genel ve İdari İşler iii) 41 Araştırma ve Geliştirme iv) 17 Yasal (Küresel Fikri Mülkiyet Koruması) v) 21% Otobüs Geliştirme, Satış ve Pazarlama</p> <p>b) AWEARE Technologies Inc. ve Global Innovation Partners Limited'in mevcut hissedarları arasında Mahesh Reddy ve Dr. Daniel Hyman bulunmaktadır. Mahesh Reddy ve Dr. Daniel Hyman aynı zamanda İhraççı'nın direktörleri ve azınlık hissedarlarıdır.</p> <p>c) Equanimity AG, tahakkuk eden toplam kripto para birimleri ve fiat ödemelerinin %3'ü oranında bir işlem ücreti almaktadır. İhraççının Direktörlerinden biri olan Marcel Füssinger, aynı zamanda Equanimity AG'nin Direktörü ve sahibidir.</p> <p>d) <b>Toplam net hasılat ve tahmini ihraç maliyetleri</b> Teklifin 1.400.000 AWEARE Global Token üzerinden toplam net geliri, fon artırımının uygulanmasına karşılık gelen yaklaşık <b>15.000.000 USD</b> tutarında olabilir. Teklifin beklenen toplam maliyeti yaklaşık <b>1.500.000 ABD Doları</b> tutarındadır ve elde edilen gelirden tahsil edilecektir.</p> <p>e) <b>Underwriting Düzenlemeleri</b> Teklif, kesin bir yüklenim anlaşmasına tabi değildir. Bir sigortacının satılmamış tokenları yüklenim altına almak zorunda olduğu bir anlaşma yoktur. Bu nedenle, arzın tamamının plase edileceğine dair bir garanti bulunmamaktadır.</p>

## XXV. SUMMARY VUM PROSPEKT

Dëse Resumé enthält all d'Elementer déi néideg sinn fir an engem Resumé fir dës Zort vu Wäertpabeieren an Emittenten abegraff ze sinn.

SEKTION 1 - Aféierung		
1.1	Numm an ISIN vun de Wäertpabeieren	Déi 1.400.000 nei Participatioun Certificaten ëffentlech sinn Net-Stëmmbezuelen Träger Participatioun Certificaten vun AWEARE Global AG. Den Numm vun dëse Participatiounszertifikater ass "AWEARE Global Tokens" D'ISIN ass LI1363014385.
1.2	Identitéit a Kontaktdetailer vum Emittent, dorënner seng legal Entity Identifier (LEI)	<b>AWEARE Global AG</b> (den „Emittent“) c/o Revalier Aktiengesellschaft Pradafant 11, 9490 Vaduz, Fürstentum vun Tel: +423 237 63 47 E-Mail: <a href="mailto:info@awearetech.li">info@awearetech.li</a> De LEI ass: 391200PTNEZNXGJW1C39
1.3	Kompetent Autoritéit	<b>Finanzmäert Autoritéit</b> (den „FMA“) Landstrasse 109, 9490 Vaduz, Fürstentum Liechtenstein Tel: +423 236 73 73 Fax: +423 236 73 74 E-Mail: <a href="mailto:info@fma-li.li">info@fma-li.li</a>
1.4	Datum vun der Genehmigung vum Prospekt	05/12/2024
1.5	Warnungen	
1.5.1	<p>a) De Resumé soll als Aféierung zu dësem Prospekt gelies ginn. All Entscheidung fir an de Wäertpabeieren ze investéieren soll op Berücksichtigung vum Prospekt als Ganz vum Investisseur baséieren.</p> <p>b) Den Investisseur kéint all oder en Deel vum investéierten Kapital verléieren.</p> <p>c) Wou eng Fuerderung betreffend Informatioun am Prospekt enthale gëtt viru Gericht bruecht, de Kläger Investisseur kéint, ënner nationalt Gesetz, d'Käschte fir d'Iwwersetzung vum Prospekt ze droen ier déi juristesche Prozeduren initiéiert ginn.</p> <p>d) Zivilverantwortung befestegt nëmmen déi Persounen, déi de Resumé mat abegraff all Iwwersetzung dovunner deposéiert hunn, awer nëmmen wann de Resumé täuschend, ongenau oder inkonsistent ass, wann se zesumme mat deenen aneren Deeler vum Prospekt gelies ginn oder et net gëtt, wann se zesumme mam Prospekt gelies ginn. aner Deeler vum Prospekt, Schlësselinformatioun fir Investisseuren ze hëllefen wann se berécksichtegt ob se an de Wäertpabeieren investéiere sollen.</p>	
SEKTION 2 - KEY INFORMATION VUN DER EMITTER		
2.1	Wien ass den Emittent vun de Wäertpabeieren?	
2.1.1	Informatioun iwwer den Emittent	
	<p>a) De legalen a kommerziellen Numm vum Emittent ass "AWEARE Global AG". Den Emittent ass eng ëffentlech limitéiert Gesellschaft, déi am Fürstentum Liechtenstein incorporéiert ass a vun de Gesetzer vum Fürstentum Liechtenstein regéiert gëtt. Den Emittent huet säi registréierte Büro zu Vaduz, Fürstentum Liechtenstein an ass am Office of Justice / Commercial Register vum Fürstentum Liechtenstein ënner der Aschreiwungsnummer FL-0002.714.015-4 registréiert.</p> <p>b) Den Zweck vum Emittent ass Sensortechnologien a kënschtlech Intelligenz fir autonom Gefierer an aner Uwendungen z'entwéckelen an ze monetiséieren.</p> <p>c) D'Haaptaktionäre vum Emittent sinn: <ul style="list-style-type: none"> <li>Global Innovation Partners Limited, British Virgin Islands mat Majoritéit Aktionären Dr. Daniel Hyman, Mahesh Reddy, Dr. Reginald Tang, a Mark Hyman</li> </ul> </p> <p>d) De Verwaltungsrot vum Emittent besteet aus: <ul style="list-style-type: none"> <li>Dr Daniel Hyman, Nationalitéit: USA, Mailing Adress: Long Beach, Kalifornien, USA</li> <li>Mahesh Reddy, Nationalitéit: USA, Mailing Adress: Irvine, Kalifornien, USA</li> <li>Marcel Füssinger, Nationalitéit: Éisträich, Mailing Address: 160009, Singapur</li> <li>Revalier AG representéiert duerch Reinhold Wohlwend, Nationalitéit: Liechtenstein, Mailing Address: 9490, Vaduz, Liechtenstein</li> </ul> </p> <p>e) Den Auditeur ass: Lucas Tihanyi, Member vun der Liechtenstein Association of Auditors and EXPERTsuisse, Industriering 14, 9491 Ruggell, Liechtenstein</p>	
2.2	Wat ass déi wichteg finanziell Informatioun iwwer den Emittent?	
2.2.1	<p>Den Emittent gouf den 30/11/2023 gegrënnt duerch Aschreiwung am Handelsregister vum Fürstentum Liechtenstein. Laut der Deklaratioun vum Verwaltungsrot vum 25. Oktober 2023 ass den Emittent net ënner engem ordinäre Audit ënnerworf an net ënner engem Audit iwwerpréift. Wéi och ëmmer, d'Joresstate vum 31. Dezember 2023 an d'Tëscherassue vum 15. Juli 2023 goufen vum Auditeur iwwerpréift.</p> <p>Déi folgend wichteg finanziell Informatioun gouf am Aklang mat de Bestëmmunge vum Liechtenstein Persons and Companies Law ('PCL') virbereet, besonnesch Art. 1024 et seq.</p>	

### Akommes Ausso

	31/12/2023	15/07/2024
<b>Total Recetten</b>	0 USD	0 USD
<b>Operatioun Gewënn / Verloscht</b>	USD -2'473,03	USD -30'150,54
<b>Netto Gewënn / Verloscht</b>	USD -2'473,03	USD -30'150,54

### Bilan

	31/12/2023	15/07/2024
<b>Total Verméigen</b>	USD 50'184,35	USD 75'244,30
<b>Total Eegekapital</b>	USD 47.526,97	USD 19'849,46
<b>Nettofinanziell Schold (laangfristeg Schold plus kuerzfristeg Schold minus Cash)</b>	0 USD	0 USD

### Cash Flow Ausso

	31/12/2023	15/07/2024
<b>Relevant Netto Cash Flow aus Operatiounsaktivitéiten</b>	0 USD	0 USD
<b>Relevant Netto Cashflow aus Investitiounsaktivitéiten</b>	0 USD	0 USD
<b>Relevant Netto Cashflow vu Finanzéierungsaktivitéiten</b>	0 USD	0 USD

D'Ausbléck vum Emittent ass net wesentlech verschlechtert zënter dem Tëschebilanzdatum wéi de 15/07/2024. Et goufe keng wesentlech Ännerungen an der Finanzplaz oder Handelspositioun vum Emittent zënter dem Berichterstattungsdatum vum Tëschebilan wéi um 15/07/2024.

#### 2.3 Wat sinn d'Schlësselrisiken déi spezifesch fir den Emittent sinn?

##### **Niddereg Kapital**

Den Zweck vum Emittent ass d'Kommerzialiséierung vun der Technologie vun AWEARE. D'Emittent Kapital ass limitéiert op USD 50,000,00, wou de Minimum Kapital erfuorderlech ënner Liechtenstein Gesetz USD 50,000,00 ass. Well den Emittent den 30/11/2023 incorporéiert gouf, si keng bedeitend historesch finanziell Daten oder Schlëselfiguren, ausser déi historesch finanziell Informatioun, déi am Abschnitt 2.2.1 vun dësem Resumé bezeechent ginn, verfügbar fir d'finanziell Situatioun vum Emittent a Relatioun ze bewäerten. zu de leschte Joeren. Den Emittent ass net ënner engem normale Audit ënnerworf an huet keng Audit Iwwerprüfung. Den Emittent gouf net vun enger Bewäertungsagentur bewäert. Niddereg Kapital representéiert e erhéicht Risiko fir den Investisseur, well d'Funktoun als responsabel Kapital entspreichend reduzéiert gëtt.

##### **Insolvenzrisiko**

#### 2.3.1

Am Fall vun der Ouverture vun Insolvenzverfahren iwwer d'Verméigen vum Emittent, gëtt den Emittent temporär oder dauerhaft an der Entsuegung vu senger Verméigen limitéiert, oder d'Dispositioun vum Verméigen vum Emittent ginn vun engem Gericht ernannten Insolvenzverwalter iwwerholl. Dëst kann en negativen Impakt op d'finanziell Positioun an d'Geschäftsaktivitéite vum Emittent hunn. Dëse Fall ka geschéien och wann Insolvenzapplikatioun falsch agefouert goufen. Am Fall vun Insolvenz vum Emittent sinn d'Participanten haftbar mat hirem investéierten Kapital. Dat investéiert Kapital soll als Eegekapital behandelt ginn an ass dofir qualifizéiert ënnergeuerdnet.

##### **Geschäftsfinanzéierung**

Et gëtt kee Mindestkapital ze sammelen. Et gëtt keng Plazéierungsgarantie, mee éischter de Risiko datt d'AWEARE Global Tokens net voll abonnéiert sinn (Placementrisiko). Wann den Emittent et net fäerdeg bréngt de gewünschten Emissiounsvolumen ze froen, kann den Emittent manner investéieren. Et besteet e Risiko vun

	<p>engem Kapitalmangel fir den Emittent. Ausserdeem bleiwen d'Emissiounskäschten, déi onofhängeg vun der Quantitéit u gesammelt Kapital sinn, wat d'Ausgabequote par rapport zum Gesamtinvestitiounskapital erhéijen. Et besteet e Risiko datt an dësem Fall den Emittent seng virgesinn Investitiounsziler net errechen an seng Verpflichtungen ënner den AWEARE Global Tokens net erfëllen kann.</p> <p><b>Management, Technologie, Drëtt Partei Service Provider Ofhängegkeet, Konkurrenz an Entwécklung Zäitframe</b>  Ee vun de Schlësselstärkten vum Emittent ass seng intelligent Notzung vun der leschter Radartechnologie. Wéi och ëmmer, technesch Virdeeler an der Informatiouns- a Kommunikatiounstechnologieindustrie kënnen kuerzfristeg sinn. Deementspreechend hänkt den Erfolleg vun der Emissioun deelweis vu senger Fäegkeet of, d'Servicer vum Emittent ze managen an auszubauen an d'Benotzerbasis vu sengem Geschäft ze wuessen an dofir Akommes ze generéieren an Äntwert op verännert Technologien, Ufuerderunge vum Benotzer an Drëtt-Partei Service Ubidder a kompetitiv Drock. . Versoen oder Verspéidungen beim Maachen kënnen den Erfolleg vum Emittent negativ beaflossen.</p> <p><b>Mënschleche Feeler mat Smart Kontrakter</b>  Den Emittent iwwerhëlt keng Haftung a mécht keng Representatiounen oder Garantien iwwer d'Funktionalitéit vum Emittentenprojet oder vun all Smart Kontrakter déi programmiert oder benotzt kënnen fir d'Sidlung vun der Offer am Aklang mat dësem Prospekt am breetste Sënn. Investisseuren kënnen Behënnerungen als Resultat leiden oder allgemeng e Gesamtverloscht hunn. Wéi och ëmmer, an esou Szenarie kënnen legal Mechanismen gëlle fir en Investisseur vu Verloscht ze schützen.</p>
<b>SEKTION 3 - KEY INFORMATION UN DER SECURITIES</b>	
3.1	<b>Wat sinn d'Hauptmerkmale vun de Wäertpabeieren?</b>
3.1.1	<b>Informatiounen iwwert d'Sécherheet</b>
a)	<p><b>Beschreibung vun der Aart a Klass vun de Wäertpabeieren</b></p> <p>Déi <b>1.400.000</b> nei Participatiounszertifikater, déi ëffentlech vum Emittent ugebuede ginn, sinn net-Stëmmbezielungszertifikater, jidderee mat engem nominale Wäert vun <b>0,01 US Dollar</b> vun der Participatioun Kapital (den "<b>AWEARE Global Tokens</b>")., vun enger neier Emissioun vum Participatiounskapital geléist vun enger ausseruerdentlecher Generalversammlung den 18/07/2024. D'Inhaber vun AWEARE Global Tokens ginn genannt "<b>Participanten</b>" oder "<b>Tokenhalter</b>".</p>
b)	<p><b>Währung vun der Wäertpabeieren Emissioun</b></p> <p>US Dollar ("<b>USD</b>" oder "\$"). De Begrëff vum AWEARE Global Token ass onlimitéiert.</p>
c)	<p><b>Beschreibung vun de Rechter déi un de Wäertpabeieren verbonne sinn</b></p> <p><b>Wahlrecht</b>  AWEARE Global Tokens sinn net-voting Participatioun Certificaten a berechtigt net de Participant op ze stëmmen, d'Zesummenzeruffen an un der Generalversammlung vum Emittent deelzehuelen. Ausserdeem ginn AWEARE Global Tokens net d'Recht op Informatioun, d'Recht op Inspektioun an d'Recht op eng Demande ze maachen. Wéi och ëmmer, eng schrëftlech Ufro fir Informatioun oder Inspektioun oder fir d'Initiatioun vun engem offiziellen Audit kann op d'Generalversammlung agereecht ginn.</p> <p><b>Ukënnegung vun Aruff an Resolutiounen vun der Generalversammlung</b>  D'Participanten musse matgedeelt ginn iwwert d'Arufe vun der Generalversammlung zesumme mat de Punkten um Ordre du jour an de Motiounen. All Resolutioun vun der Generalversammlung muss ouni Verspéidung vun de Participanten um registréierte Büro vum Emittent zur Inspektioun zur Verfügung gestallt ginn. D'Participanten ginn an der Notifikatioun doriwwe informéiert.</p> <p><b>Dividendrecht an Undeel vun der Liquidatioun Erléis</b>  AWEARE Global Tokens droen voll Dividendrechter vum Datum vun der gültiger Acquisitioun an berechtigt hir Besëtzer op en Deel vun der Liquidatiounserléisung am Verhältnis zu hirer Participatioun an der Participatioun Kapital. D'Emittent plangt de Moment net Dividenden an der nächster Zukunft ze verdeelen. Och wann eng Forderung op Dividenden ënner den Statuten existéiert, gi keng Prognosen iwwer zukünfteg Dividendverdeelunge gemaach. Den Emittent wëll de Gewinn nei an de weidere Wuesstum an Entwécklung vun der Firma reinvestéieren.</p> <p><b>Form a Securitisiatioun</b>  AWEARE Global Tokens ginn als Tokens ausgestallt. Tokens si Wäertrechter déi op enger dezentraliséierter Datebank (Blockchain) ausgestallt ginn an dohinner transferéiert ginn. De Blockchain fir dësen Zweck benotzt ass den Ethereum Blockchain.</p> <p><b>Ausgrenzung vun Abonnement Rechter an Participatioun Rechter</b>  Bis d'Ziel-Participatiounskapital vun USD 50,000 erreecht ass, sinn d'Präferenzrechter no den Artikelen 304d, 304f an 304g PCL, besonnesch</p>



		<p>d'Abonnementsrechter an d'Participatiounsrechter vun de Participanten, ausgeschloss.</p> <p><b>Transferabilitéit vun de Wäertpabeieren</b> Den Transfer (wéi Transfer am enke Sënn, Verpflichtung, Ierfschaft) vun AWEARE Global Tokens erfuerdert d'Zustimmung vum Verwaltungsrot vum Emittent. D'Transferabilitéit ass also zu engem gewësse Mooss limitéiert. Op jidde Fall ass en Transfer vun AWEARE Global Tokens net erlaabt wann se dann vun enger Persoun an engem Land gehale ginn an deem AWEARE Global Tokens net ugebuede ginn. En Transfert am uewe genannte Sënn gëtt och ugesinn wann en Tokenholder seng Residenz an e Land plënnert an deem AWEARE Global Tokens net ugebuede kënnen ginn.</p>
d)	<b>Relativ Senioritéit vun de Wäertpabeieren an der Kapitalstruktur vum Emittent am Fall vun Insolvenz</b>	Am Fall vun Insolvenz vum Emittent sinn d'Participanten haftbar mat hirem investéierten Kapital. Dat investéiert Kapital soll als Eegekapital behandelt ginn an ass dofir qualifizéiert ënnergeuerdet.
e)	<b>Beschreibung vun Dividend Politik</b>	Keng Dividenden goufen bis haut bezuelt. Den Emittent mécht keng Profitprognosen oder Schätzungen an dofir gëtt eng Beschreiwung vun der Dividendpolitik net gemaach. Dividenden, wann iwwerhaupt, ginn an USD bezuelt. Den Emittent behält sech d'Recht fir Dividenden och an enger anerer Währung oder cryptocurrency ze bezuelen. All Resolutioun fir Dividenden ze bezuelen gëtt am Aklang mat applicabel Gesetz geholl a hänkt ënner anerem vun de Resultater vun der Emittent vun Operatiounen, finanzieller Positioun, kontraktuelle Restriktiounen a Kapitalfuerderunge of. Op jidde Fall ginn 5% vum Nettogewënn un d'gesetzlech Reserven zougedeelt, bis deen den Betrag vun 10% vum abezuelten Aktiekapital erreicht huet.
<b>3.2</b>	<b>Wou ginn d'Sécherheeten gehandelt?</b>	
<b>3.2.1</b>	AWEARE Global Tokens ginn net op engem reglementéierte Maart gehandelt. Den Emittent behält sech d'Recht fir den Zougang zum Handel op engem reglementéierte Maart unzefroen.	
<b>3.4</b>	<b>Wat sinn d'Schlësselrisiken déi spezifesch sinn fir d'Sécherheeten?</b>	
<b>3.4.1</b>	<p><b>Investisseuren Portemonnaie a private Schlëssel Risiko</b> Den Investisseur eleng dréit de Risiko vun der Auswiel vum Portemonnaie oder der Plaz vum private Schlëssel. Wann en inkompatibel Portemonnaie benotzt gëtt oder wann de private Schlëssel verluer ass, ass den Zougang zu den AWEARE Global Tokens normalerweis onméiglech. D'Konsequenzen, wéi zum Beispill de Gesamtverloscht vun der Investitioun, mussen eleng vum Investisseur gedroe ginn.</p> <p><b>Risiko vu Verkefbarkeet, Liquiditéit a Realiséierungsrisiko</b> Et gëtt keng Sécherheet datt e flëssege Maart fir d'AWEARE Global Tokens entwéckelt. Als Resultat konnten AWEARE Global Tokens net op engem Secondaire Maart verkaaft ginn, wat Liquiditéitsrisiko fir den Investisseur erstellt.</p> <p><b>Volatilitéit Risiko</b> Et gi Risiken am Zesammenhang mat der Volatilitéit vum Aktienpräis. Wann AWEARE Global Tokens verkaaft gi sinn a si an enger schaarfer erofgaang Präisschwankung gefaange ginn, kéint den Tokenholder Verloschter leiden, e puer vun deenen substantiell kënnen sinn, als Resultat vum Verkaf.</p> <p><b>Verloscht vun Tokens</b> Tokens kënnen verluer ginn oder onzougängelech ginn, besonnesch wann den Tokenholder de jeweilige private Schlëssel verléiert fir seng AWEARE Global Tokens ze entsuergen oder wéinst enger Feelfunktioun vum E-Portemonnaie an deem d'AWEARE Global Tokens gespäichert sinn. Dëst kéint zum Verloscht vun Tokens féieren. Et ass déi eenzeg Verantwortung vum Tokenholder fir de private Schlëssel sécher ze späicheren an ze schützen, deen den Zougang zum E-Portemonnaie erlaabt. Tokens kënnen och onzougängelech ginn am Fall vum Doud vun engem Tokenholder wann hien oder hatt keng Arrangementer fir esou Fäll gemaach huet. Weder den Emittent nach all aner Kierper oder Institutioun wäert fäeg sinn den Zougang zu de Portemonnaie vum Tokenholder fir d'Nofolger vum Tokenholder ze restauréieren. De Verloscht vu private Schlëssele kéint och d'Disponibilitéit vu verschiddene Funktionalitéite vum STO an den AWEARE Global Tokens reduzéieren. Besonnesch kann et onméiglech sinn AWEARE Global Tokens un Abonnente auszeginn oder se iwwerdrobar ze maachen, an deem Fall si se onbestëmmt gepaust bleiwen. Ausserdeem kann et onméiglech sinn Dividendbezielungen ze maachen. Schlussendlech ass et e Risiko datt en Ugräifer AWEARE Global Tokens fir net bäitriedende Adressen mintéiere kann, de Confirmatiounsstatus änneren, onkontrolléiert Betrag un d'STO bäidroen oder den Ugräifer erlaben onerfuerderten Dividendbezielungen zrëckzéien.</p> <p><b>Limitéiert Rechter vun Tokenholder</b> AWEARE Global Tokens sinn net-voting Participatioun Certificaten a berechtigt net d'Tokenholders ze stëmmen, d'Zesummenzeruffen an un der Generalversammlung vum Emittent deelzehuelen. Ausserdeem ginn AWEARE Global Tokens net d'Recht op Informatioun, d'Recht op Inspektioun an d'Recht op eng Demande ze maachen. D'Generalversammlung vum Emittent kann dofir Resolutiounen uhuelen, déi d'Rechter vun Tokenholder negativ</p>	

	<p>beaflosse kënnen. Tokenholders hu keng Méiglechkeet d'Benotzung vum Erléis aus der Emissioun vun AWEARE Global Tokens ze kontrolléieren. Den Transfer (wéi Transfer am enke Sënn, Verpflichtung, Ierfschaft) vun AWEARE Global Tokens erfuerdert d'Zustimmung vum Verwaltungsrat vum Emittent. Op jidde Fall ass en Transfer vun AWEARE Global Tokens net erlaabt wann se dann vun enger Persoun an engem Land gehale ginn an deem AWEARE Global Tokens net ugebuede ginn. En Transfert am uewe genannte Sënn gëtt och ugesinn wann en Tokenholder seng Residenz an e Land plënnert an deem AWEARE Global Tokens net ugebuede kënnen ginn. D'gesetzlech Abonnementsrecht vun den Tokenhalter am Fall vun enger Kapitalerhéijung ënner dëser Offer ass ausgeschloss.</p> <p><b>Tokenholder Fuerderunge sinn ënnergeuerdnet</b> D'Rechter vun Tokenhalter fir Dividendbezielungen vum Emittent ze froen an ze kréien ass Junior un d'Fuerderunge vun all Inhaber vun onsubordinéierte Verpflichtungen vum Emittent. Bei enger Liquidatioun vum Emittent ginn Tokenhalter nëmme bezuelt wann an nodeems all Senior Obligatiounen vum Emittent entlooss goufen.</p>
<b>SEKTIOUN 4 - SCHLECHTELLECH INFORMATIOUN UN DER OFFERT VUN DER ÉFFLECH</b>	
<b>4.1</b>	<b>Ënner wéi enge Konditiounen an Zäitplang kann ech an dës Sécherheet investéieren?</b>
<p><b>Länner an deenen d'Sécherheeten ugebuede ginn</b> D'Offer besteet aus effentlechen Offeren an Éisträich, Belsch, Bulgarien, Kroatien, Zypern, Tschechesch Republik, Dänemark, Estland, Finnland, Frankräich, Däitschland, Griicheland, Ungarn, Island, Irland, Italien, Lettland, Liechtenstein, Litauen, Lëtzebuerg, Malta, Holland, Norwegen, Polen, Portugal, Rumänien, Slowakei, Slowenien, Spuenien, Schweden, Schwäiz souwéi privat Placementer a bestëmmte Jurisdictione ausserhalb.</p> <p><b>Länner an deenen d'Sécherheeten net ugebuede ginn</b> AWEARE Global Tokens vum Emittent sinn net a wäerten net ënner de Bestëmmunge vum US Securities Act vum 1933 registréiert ginn, wéi amendéiert, oder mat de Securities Reguléierungsautoritéiten vun all Staat vun de Vereenegte Staate vun Amerika, oder an Australien, Japan oder Kanada. Deementspreechend gi se net direkt oder indirekt un de Public ugebueden, verkaaft oder geliiwert, ausser no enger Befreiung vun den Ufuerderunge vun den Aschreiwungen. Besonnesch ass dëst Prospekt net eng Offer fir ze verkafen oder d'Ufro vun enger Offer fir AWEARE Global Tokens an de Vereenegte Staate vun Amerika, Australien, Japan a Kanada ze kafen a kann net do verdeelt ginn. Zousätzlech ass dëst Prospekt net eng Offer fir ze verkafen oder d'Ufro vun enger Offer fir AWEARE Global Tokens a Russland, Iran oder Nordkorea, Wäissrussland, Syrien oder all Territoiren dovun ze kafen. A dierf net dra verdeelt ginn.</p> <p><b>Offeren</b> Den Abonnementprozess fir AWEARE Global Tokens fënnt online statt <a href="https://kyc.awearetech.li/">https://kyc.awearetech.li/</a> (den "Dashboard").</p> <p><b>Offer Period</b> D'Period, während där d'Investisseuren hir Akafsoffere fir AWEARE Global Tokens ofginn kënnen, fänkt um Datum vun der Genehmigung vum Prospekt un an e Joer méi spéit op en Enn (de "Offer Period"). Um leschten Dag vun der Offer Period kënnen Offere bis 12:00 Auer Liechtenstein Zäit gemaach ginn.</p> <p><b>Offer Präis</b> D'Offer Präis vun engem AWEARE Token ass <b>USD 12,00</b> (den "Offer Präis").</p> <p>Fir fréi Investitioun ze encouragéieren, sinn déi folgend Remise verfügbar:</p> <p>Fir Investitiounen tëscht 10.000 USDC an 49.999.99 USDC kréien Investisseuren eng Remise vun 10%, wat de Präis pro AWEARE Token USD10.80 mécht.</p> <p>Fir Investitiounen vu 50.000 USDC oder méi kréien Investisseuren eng Remise vu 15%, wat de Präis pro AWEARE Token USD10,20 mécht.</p> <p><b>Disponibilitéit vun Remise</b> Déi uewe genannte Remise sinn verfügbar <b>bis ee vun de folgende geschitt, wat och ëmmer als éischt kënt:</b></p> <ul style="list-style-type: none"> <li>• <b>erreechen en Gesamtinvestitionsvolumen vun 5.000.000 USDC</b>, oder</li> <li>• <b>Oflaf vun dräi Méint vum Ufank vun der Offer.</b></li> </ul> <p><b>Liiwwerung a Siidlung</b> All Investisseur muss den Online Abonnementprozess um Dashboard ofgeschloss hunn. AWEARE Global Tokens ginn off-chain als Rekord an der Datebank vum Emittent zougewisen, déi duerch den Dashboard sichtbar ka sinn, géint d'Bezielung vum Offerpräis. AWEARE Global Tokens ginn op der Kette am Smart Kontrakt spéitstens bannent zwee Méint nom Enn vun der Offer Period zougewisen. Wann d'total Offer vun AWEARE Global Tokens (nodeems d'Zilparticipatiounskapital erreecht gouf) eriiwwer ass an den Emittent decidéiert huet de Smart Kontrakt ze finaliséieren, ginn AWEARE Global Tokens an d'Krypto Portemonnaie vum Investisseur geliiwert.</p> <p><b>Verdünnung</b> Zënter datt d'gesetzlech Abonnementsrecht vun alle Participanten am Fall vun enger Kapitalerhéijung am Kader vun dëser Offer ausgeschloss ass, ginn d'Participanten vun dëser Offer net verdünnt.</p>	

**Total Netto Erléis a geschätzte Emissiounskäschte**

Den Total Netto Erléis vun der Offer iwver 1.400.000 AWEARE Global Tokens kann op ongeféier **USD 15,000,000** entspreichend der Ëmsetzung vun der Fong Erhéijung. Déi erwaart Gesamtkäschte vun der Offer sinn ongeféier **USD 1.500.000** a gëtt vum Erléis verrechent.

<b>4.2</b>	<b>Firwat gëtt dëse Prospekt produzéiert?</b>
<b>4.2.1</b>	<p>a) De geschätzte Netto Erléis aus der Emissioun vun de Wäertpabeieren gëtt haaptsächlech fir Fuerschung an Entwécklung an IP Schutz benotzt. Et kéint néideg sinn bis zu 50% vun engem zougewisenen Budget op eng aner Positioun ze verschwannen wann néideg.</p> <ul style="list-style-type: none"><li>i) 10% Käschte vun Erhéijung</li><li>ii) 11% Allgemeng &amp; Administrativ</li><li>iii) 41% Fuerschung &amp; Entwécklung</li><li>iv) 17% legal (global IP Schutz)</li><li>v) 21% Bus Dev, Verkaf &amp; Marketing</li></ul> <p>b) Déi aktuell Aktionäre vun AWEARE Technologies Inc. a Global Innovation Partners Limited enthalen Mahesh Reddy an Dr Daniel Hyman. Mahesh Reddy an den Dr Daniel Hyman sinn och Direkteren a Minoritéitsaktionäre vum Emittent.</p> <p>c) Equanimity AG kritt eng Transaktionsgebühr vun 3% vun de gesamten Krypto-Währungen a Fiat-Bezuelungen. De Marcel Füssinger, deen ee vun den Direktere vum Emittent ass, ass och den Direkter a Besëtzer vun der Equanimity AG.</p> <p>d) <b>Total Netto Erléis a geschätzte Emissiounskäschte</b> Den Total Netto Erléis vun der Offer iwver 1.400.000 AWEARE Global Tokens kann op ongeféier <b>USD 15,000,000</b> entspreichend der Ëmsetzung vun der Fong Erhéijung. Déi erwaart Gesamtkäschte vun der Offer sinn ongeféier <b>USD 1.500.000</b> a gëtt vum Erléis verrechent.</p> <p>e) <b>Underwriting Arrangementen</b> D'Offer ass net ënnerleien zu engem festen Underwriting Accord. Et gëtt keen Accord ënner deem en Underwriter verpflichtet ass, net verkaafte Tokens z'ënnerschreien. Dofir gëtt et keng Garantie datt d'ganz Offer plazéiert gëtt.</p>

## **XXVI. MAIN BODY OF THE PROSPECTUS**

### **1. Persons responsible, third party information and competent authority approval**

#### **1.1 Persons responsible**

AWEARE Global AG, the Issuer, with its registered office in Vaduz, Principality of Liechtenstein, assumes responsibility for the contents of this Prospectus in accordance with Art 4 of the Liechtenstein EEA-Securities Prospectus Implementation Act (EWR-Wertpapierprospekt-Durchführungsgesetz, EWR-WPPDG) and hereby declares that, to the best of its knowledge, the information contained in this Prospectus is accurate and that no material matters have been omitted.

The Issuer further declares that it has taken all reasonable care to ensure that the information contained in this Prospectus is, to the best of its knowledge, in accordance with the facts and contains no omission likely to affect the import of the Prospectus.

In the event that an investor asserts claims before a court on the basis of the information contained in the prospectus, the investor acting as plaintiff may be obliged under the national laws of the countries of the European Economic Area (EEA) to bear the costs of translating the prospectus prior to the commencement of legal proceedings.

#### **1.2 Deviating Representation**

No person shall be entitled to provide information or representations that differ from those contained in this Prospectus. Any information or representation which deviates from this Prospectus, with the exception of one or more subsequent publications by the Issuer, if any, shall be deemed not to have been authorised by the Issuer.

#### **1.3 Statement**

- The Prospectus has been approved by the Financial Market Authority of Liechtenstein, as competent authority under Regulation (EU) 2017/1129.
- The Financial Market Authority of Liechtenstein only approves this Prospectus as meeting the standards of completeness, comprehensibility and consistency imposed by Regulation (EU) 2017/1129.
- Such approval should not be considered as an endorsement of the quality of the securities that are the subject of this Prospectus.
- Such approval should not be considered as an endorsement of the Issuer that is the subject of this Prospectus.
- Investors should make their own assessment as to the suitability of investing in the securities.

## 1.4 Information Sourced from Third Parties

The following information, which has been taken from third parties, has been reproduced correctly and, to the best of the Issuer's knowledge and as far as can be ascertained from the information published by the third party, is not incorrect or misleading due to omissions:

The list is ordered as bibliography; it is a list of sources referenced in the document, providing full details of the materials consulted for research and verification.

Ref	Authors	Title	Publish Date	Source	URL
1,6,7	By Chris Isidore	Tesla recalls nearly all 2 million of its vehicles on US roads	13.12.2023	CNN Business	<a href="https://www.cnn.com/2023/12/13/tech/tesla-recall-autopilot/index.html">https://www.cnn.com/2023/12/13/tech/tesla-recall-autopilot/index.html</a>
2	MICHAEL LIEDTKE	California regulators suspend recently approved San Francisco robotaxi service for safety reasons	25.10.2023	AP News	<a href="https://apnews.com/article/driverless-car-s-cruise-california-robotaxis-8aa872f6b87bbff59e9c86471e87b0e7">https://apnews.com/article/driverless-car-s-cruise-california-robotaxis-8aa872f6b87bbff59e9c86471e87b0e7</a>
3	Rob Wile and Tom Costello	New Car Safety Technology Required in the US: What and When	30.04.2023	NBC News	<a href="https://www.nbcnews.com/business/autos/new-car-safety-technology-required-in-the-us-what-and-when-rcna149790">https://www.nbcnews.com/business/autos/new-car-safety-technology-required-in-the-us-what-and-when-rcna149790</a>
4	Aarian Marshall	Why Self-Driving Cars Keep Crashing	29.05.2018	Wired	<a href="https://www.wired.com/story/self-driving-cars-uber-crash-false-positive-negative/">https://www.wired.com/story/self-driving-cars-uber-crash-false-positive-negative/</a>
5,8	Stephen Williams	Tesla Full Self-Driving Thanksgiving Bay Bridge Crash Videos	10.01.2023	Autoblog	<a href="https://www.autoblog.com/2023/01/10/tesla-full-self-driving-thanksgiving-bay-bridge-crash-videos/">https://www.autoblog.com/2023/01/10/tesla-full-self-driving-thanksgiving-bay-bridge-crash-videos/</a>
9,17	Jack Stewart	Why Tesla Autopilot Crashes Without Radar	27.08.2018	Wired	<a href="https://www.wired.com/story/tesla-autopilot-why-crash-radar/">https://www.wired.com/story/tesla-autopilot-why-crash-radar/</a>
10, 11	W. Schonken	Modeling and Mitigation of Specular Multipath Interference in a Dual-Frequency Phase-Comparison FMCW Radar System	2017	Chalmers University of Technology	<a href="https://odr.chalmers.se/handle/20.500.12380/253411">https://odr.chalmers.se/handle/20.500.12380/253411</a>
12	Bogdan Popa	How Windshield Water Repellent Products Work	11.03.2012	Autoevolution	<a href="https://www.autoevolution.com/news/how-windshield-water-repellent-products-work-43296.html">https://www.autoevolution.com/news/how-windshield-water-repellent-products-work-43296.html</a>
13	Unknown	LiDAR Sensor View of the BIAS Show Floor	N/A	Carmelo Walsh Law Firm	<a href="https://www.carmelowalsh.com/wp-content/uploads/2015/09/lidar-sensor-view-of-the-baias-show-floor-hl.jpg">https://www.carmelowalsh.com/wp-content/uploads/2015/09/lidar-sensor-view-of-the-baias-show-floor-hl.jpg</a>
14	Aarian Marshall	Why Self-Driving Cars Keep Crashing	29.05.2018	Wired	<a href="https://www.wired.com/story/self-driving-cars-uber-crash-false-positive-negative/">https://www.wired.com/story/self-driving-cars-uber-crash-false-positive-negative/</a>
15	Unknown	The final 11 seconds of a fatal Tesla Autopilot crash	2023	The Washington Post	<a href="https://www.washingtonpost.com/technology/interactive/2023/tesla-autopilot-crash-analysis/">https://www.washingtonpost.com/technology/interactive/2023/tesla-autopilot-crash-analysis/</a>
16, 24	Dr James Jeffs	Tesla Dropping Radar Was a Mistake - Here Is Why	06.01.2022	IDTechEx	<a href="https://www.idtechex.com/en/research-article/tesla-dropping-radar-was-a-mistake-here-is-why/25619">https://www.idtechex.com/en/research-article/tesla-dropping-radar-was-a-mistake-here-is-why/25619</a>
18	By Chris Isidore and Peter Valdes-Dapena,	Tesla is under investigation because its cars keep hitting emergency vehicles	17.08.2021	CNN Business	<a href="https://www.cnn.com/2021/08/16/business/tesla-autopilot-federal-safety-probe/index.html">https://www.cnn.com/2021/08/16/business/tesla-autopilot-federal-safety-probe/index.html</a>
19	Steve Hanley	Tesla's Trouble with Trucks and Another Shakeup of the Autopilot Team	21.05.2019	CleanTechnica	<a href="https://cleantechnica.com/2019/05/21/teslas-trouble-with-trucks-and-another-shakeup-of-the-autopilot-team-is-there-a-connection/">https://cleantechnica.com/2019/05/21/teslas-trouble-with-trucks-and-another-shakeup-of-the-autopilot-team-is-there-a-connection/</a>
20	Jay Ramey	NTSB to Probe Autopilot After Tesla Model S Rear-Ends Parked Fire Truck	24.01.20218	Autoweek	<a href="https://www.autoweek.com/news/technology/a1689671/ntsb-probe-autopilot-after-tesla-model-s-rear-ends-parked-fire-truck/">https://www.autoweek.com/news/technology/a1689671/ntsb-probe-autopilot-after-tesla-model-s-rear-ends-parked-fire-truck/</a>
21	Unknown	IEEE Microwave Magazine	Unknown	IEEE	<a href="https://mtt.org/publications/ieee-microwave-magazine/">https://mtt.org/publications/ieee-microwave-magazine/</a>

22	D. Hyman	Sensor device for driverless vehicles having shrouded slot antenna with high isolation in printed substrates.	Pending	USPTO	<a href="https://www.uspto.gov">https://www.uspto.gov</a>
23	D. Hyman and M. Hyman	Sensor device for driverless vehicles having improved elevation resolution	Pending	USPTO	<a href="https://www.uspto.gov">https://www.uspto.gov</a>
25	Unknown	The Chief Reason that FPGAs Are Used in RADAR Systems	Unknown	OSTI	<a href="https://www.osti.gov/servlets/purl/1502742">https://www.osti.gov/servlets/purl/1502742</a>
26	Texas Instruments	Automotive radar interference detection and mitigation discussion	05.08.2021	YouTube	<a href="https://www.youtube.com/watch?v=My9907sQ4o">https://www.youtube.com/watch?v=My9907sQ4o</a>
27	Texas Instruments	Ghost Targets Generated by Wall Reflection	22.09.2021	E2E Support Forums	<a href="https://e2e.ti.com/support/sensors-group/sensors/f/sensors-forum/1038453/iwr6843isk-ods-ghosts-targets-generated-by-wall-reflection">https://e2e.ti.com/support/sensors-group/sensors/f/sensors-forum/1038453/iwr6843isk-ods-ghosts-targets-generated-by-wall-reflection</a>
28	By Rob Wile and Tom Costello	Biden administration to require advanced safety tech on all new cars and trucks	30.04.2024	NBC News	<a href="https://www.nbcnews.com/business/autos/new-car-safety-technology-required-in-the-us-what-and-when-rcna149790">https://www.nbcnews.com/business/autos/new-car-safety-technology-required-in-the-us-what-and-when-rcna149790</a>
29	Unknown	True Redundancy	Unknown	Mobileye	<a href="https://www.mobileye.com/technology/true-redundancy/">https://www.mobileye.com/technology/true-redundancy/</a>
30	By Tova Cohen, Ari Rabinovitch	Intel to Buy Mobileye for \$15.3 Billion in Bid to Lead Self-Driving Car Market	14.03.2017	Reuters	<a href="https://www.reuters.com/article/us-intel-mobileye-idUSKBN16K0Z4">https://www.reuters.com/article/us-intel-mobileye-idUSKBN16K0Z4</a>
31	Unknown	Patent Licensing Royalty Rates	Unknown	UpCounsel	<a href="https://www.upcounsel.com/patent-licensing-royalty-rates">https://www.upcounsel.com/patent-licensing-royalty-rates</a>
32	Unknown	Crowded Trains in Tokyo	Unknown	Reddit	<a href="https://www.quora.com/What-do-you-think-about-the-crowded-trains-in-Tokyo">https://www.quora.com/What-do-you-think-about-the-crowded-trains-in-Tokyo</a>
33	Unknown	Shanghai Metro Map	Unknown	Shanghai Map 360	<a href="https://shanghaimap360.com/shanghai-metro-map">https://shanghaimap360.com/shanghai-metro-map</a>
34	Stephen Chen	China Puts Trust in AI to Maintain Largest High-Speed Rail Network on Earth	12.03.2024	South China Morning Post	<a href="https://www.scmp.com/news/china/science/article/3255039/china-puts-trust-ai-maintain-largest-high-speed-rail-network-earth">https://www.scmp.com/news/china/science/article/3255039/china-puts-trust-ai-maintain-largest-high-speed-rail-network-earth</a>
35	Unknown	Wuxi Metro Map	Unknown	TravelChinaGuide	<a href="https://www.travelchinaguide.com/images/map/jiangsu/wuxi-metro.jpg">https://www.travelchinaguide.com/images/map/jiangsu/wuxi-metro.jpg</a>
36	Unknown	About LeddarTech	Unknown	LeddarTech	<a href="https://leddartech.com/about-leddartech/">https://leddartech.com/about-leddartech/</a>
37	Unknown	Radar Systems Market	Unknown	Mordor Intelligence	<a href="https://www.mordorintelligence.com/industry-reports/radar-systems-market">https://www.mordorintelligence.com/industry-reports/radar-systems-market</a>
38	McKinsey & Company	Autonomous Driving's Future: Convenient and Connected	06.01.2023	McKinsey & Company	<a href="https://www.mckinsey.com/industries/automotive-and-assembly/our-insights/autonomous-drivings-future-convenient-and-connected">https://www.mckinsey.com/industries/automotive-and-assembly/our-insights/autonomous-drivings-future-convenient-and-connected</a>
40	Brad Templeton	Former Head Of Tesla AI Explains Why They've Removed Sensors, Others Differ	31.10.2022	Forbes	<a href="https://www.forbes.com/sites/bradtempleton/2022/10/31/former-head-of-tesla-ai-explains-why-theyve-removed-sensors-others-differ/">https://www.forbes.com/sites/bradtempleton/2022/10/31/former-head-of-tesla-ai-explains-why-theyve-removed-sensors-others-differ/</a>

## 2. Strategy, Performance and Business Environment

### 2.1 Information about the Issuer

The legal and commercial name of the Issuer is "AWEARE Global AG". The Issuer was founded on 30/11/2023. The Issuer has its registered office in Vaduz, Principality of Liechtenstein, and is registered with the Office of Justice / Commercial Register of the Principality of Liechtenstein under

registration number FL-0002.714.015-4. The Issuer is a public limited company incorporated in the Principality of Liechtenstein and governed by the law of the Principality of Liechtenstein. The LEI is 391200PTNEZNXGJW1C39.

The contact details of the Issuer are:

**AWEARE Global AG**

c/o Revalier Aktiengesellschaft Pradafant 11 9490 Vaduz

PRINCIPALITY OF LIECHTENSTEIN

Tel: +423 237 63 47

Email: [info@awearetech.li](mailto:info@awearetech.li), Web: <http://awearetech.li/>

**Disclaimer:** The information on the website does not form part of the Prospectus unless that information is incorporated by reference into the Prospectus.

## 2.2 Business overview

AWEARE Global has unveiled a novel radar technology that surpasses state-of-the-art Frequency-Modulated Continuous Wave (FMCW) automotive radar technology, setting a new standard for resolution and reliability. This technology is particularly timely, as Tesla recently recalled two million vehicles,<sup>1</sup> and California has sidelined GM/Cruise robo-taxi operations.<sup>2</sup> And the Biden administration in USA recently announced plans to require cars to be able to detect pedestrians in the dark.<sup>3</sup>



The quest for an ideal sensor led AWEARE to pursue signal processing methods that combine the strengths of LiDARs and radars. This entails building upon the cost-effectiveness and all-weather suitability of radar but matching LiDAR's resolution. Independent radar experts have verified that AWEARE "is beyond the state of the art", exceeding range/velocity resolution by 2x to 3x and eliminating 80%+ of false positives compared to FMCW radar.

The reduction in false positives is a key breakthrough, as they cause dangerous braking events for semi-autonomous and self-driving vehicles.<sup>4,5</sup> The implications are far-reaching for cars, trucks, robots, rail, security, and law enforcement applications. The technology is inclusive and complementary, able to be used with chipsets from established suppliers such as Infineon, NXP, IMEC, STMicrosystems, Analog Devices, Bosch, and Texas Instruments, as well as startups like Arbe Robotics. This allows AWEARE to pursue an aggressive strategy to secure first-mover advantage driving widespread adoption. Projections assume aggressive pricing at less than 1/3 industry norms.

AWEARE Global is seeking capital to expedite commercialization while paving the way for integration into multiple industries. The valuation as determined by BDO (a top five global accounting network) at \$100M only considers revenue from automotive and light rail, while discounting other sectors. There is substantial room for growth beyond these assumptions if the technology gains wider traction.

<sup>1</sup> <https://www.cnn.com/2023/12/13/tech/tesla-recall-autopilot/index.html>

<sup>2</sup> <https://apnews.com/article/driverless-cars-cruise-california-robotaxis-8aa872f6b87bfff59e9c86471e87b0e7>

<sup>3</sup> <https://www.nbcnews.com/business/autos/new-car-safety-technology-required-in-the-us-what-and-when-rcna149790>

<sup>4</sup> <https://www.wired.com/story/self-driving-cars-uber-crash-false-positive-negative/>

<sup>5</sup> <https://www.autoblog.com/2023/01/10/tesla-full-self-driving-thanksgiving-bay-bridge-crash-videos/>



### 2.2.1 Strategy & objectives - Navigating the Evolution of Autonomous Driving: Challenges, Setbacks, and the Promise of AWEARE Radar

Autonomy as the future of transportation holds the promise of revolutionising accessibility, particularly for the elderly, youth, and disabled. However, recent setbacks, notably the recall of approximately two million Tesla cars<sup>6</sup> and the sidelining of GM Cruise robotaxis in San Francisco<sup>7</sup>, have cast a spotlight on the formidable challenges that must be overcome to usher in the era of self-driving cars.

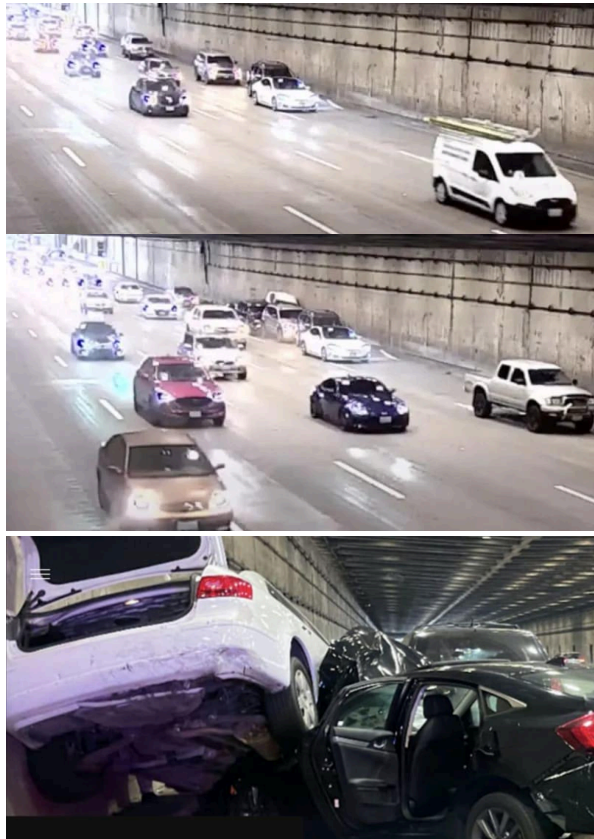

One critical challenge facing autonomous vehicles has been the poor performance and reliability of sensors. The tragic accident five years ago involving an Uber self-driving vehicle and the death of bicyclist Elaine Herzberg brought to light a harsh reality that persists today as similar accidents continue to occur. Available technology can provide incorrect or incomplete data caused by false targets and inadequate resolution. These limitations may result in autonomous vehicles performing dangerous high-speed emergency braking to avoid phantoms, or, even worse, failing to recognize persons, animals, and other vehicles as real objects. An example of phantom braking is the eight-car San Francisco Bay Bridge accident.<sup>8</sup> The problems are so pervasive that in order to avoid being confused by ghosts and avoid phantom braking, Wired magazine reports "Semi-autonomous systems are designed to ignore unmoving obstacles because otherwise, they couldn't work at all..."<sup>9</sup> Obviously, this status is not ideal.

Emerging next-generation imaging radars have made major strides in improving resolution, but still suffer from "ghosts", which are targets that are seen but are not real. One classic example is the wall-bounce ghost shown in the following figure. The radar signal transmission bounces off a guardrail or wall at the road shoulder and "sees" a phantom car at approximately the same range behind the wall as the real car straight ahead of the radar. The main types of ghosts include multi-path and specular (maths-based) artefacts that are problems for traditional radar because they appear to be real until studied over time and compared with the data from other sensors in the car.<sup>10</sup> These technology issues cause accidents and, unfortunately, claim lives.

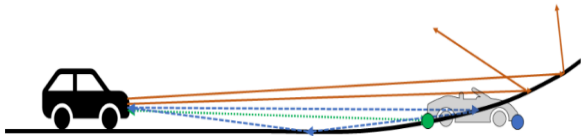
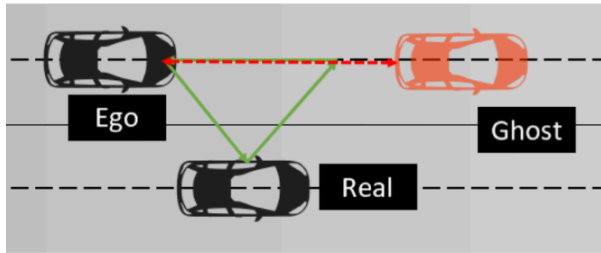

<sup>6</sup> <https://www.cnn.com/2023/12/13/tech/tesla-recall-autopilot/index.html>  
<sup>7</sup> <https://apnews.com/article/driverless-cars-cruise-california-robotaxis-8aa872f6b87bbff59e9c86471e87b0e7>  
<sup>8</sup> <https://www.autoblog.com/2023/01/10/tesla-full-self-driving-thanksgiving-bay-bridge-crash-videos/>  
<sup>9</sup> <https://www.wired.com/story/tesla-autopilot-why-crash-radar/>  
<sup>10</sup> Modeling and Mitigation of Specular Multipath Interference in a Dual-Frequency ...FMCW Radar System, W. Schonken, 2017.



The figure above illustrates an example of how a ghost can occur in front of an Ego (radar transmitting) vehicle.<sup>11</sup> The radar signal reflects off the uneven surface of an adjacent car (green path) before bouncing off the ground in front of the Ego vehicle (red path). In another scenario shown in the right figure, a false positive can occur when the radar signal bounces off the ground with elevation ahead of the Ego vehicle, so another vehicle in the field of view is not even needed at all in order to confuse an autonomous control system.

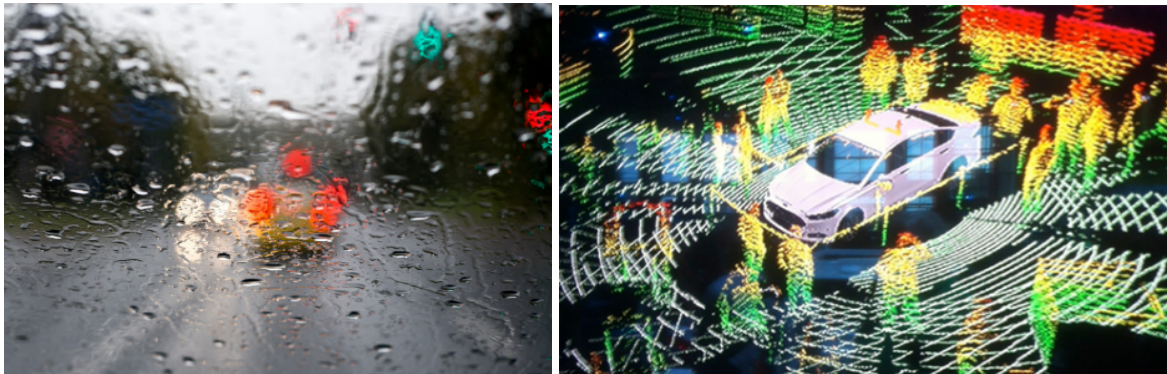

Figure: Self-driving cars use many sensors; cameras<sup>12</sup> and LiDARs<sup>13</sup> struggle in bad weather.

In the pursuit of overcoming these challenges, AWEARE has demonstrated revolutionary radar technology that delivers superior resolution while reducing false positive rates with three independent radar experts verifying that AWEARE “is beyond the current state of the art.” AWEARE radar’s resolution actually exceeds experimentally perceived performance limitations of conventional FMCW automotive radar technology. Additionally, the radar boasts a remarkable achievement - it reduces false positives by 80%. If successfully integrated into autonomous vehicles, this technology could potentially mitigate the risks associated with false positives and enhance the overall safety and performance of self-driving cars.

To implement AWEARE’s technology, execution can be straightforward. Algorithms and waveforms are compatible with industry radar chipsets. Beyond software, hardware signal processing keys are used to unlock the power of the technology while conferring IP protection. Leveraging compatibility with existing chipsets, algorithms and technologies can be quickly implemented. This may be central to gaining first mover advantage while allowing partners and customers to capitalise on performance and reliability advantages under an attractive licensing model. As the overall industry grapples with setbacks, breakthroughs like these pioneered by AWEARE underscore the dynamic nature of this industry. Innovative sensor solutions may hold the key to both realising the transformative potential of autonomy as well as improving the effectiveness and safety of existing Advanced Driver Assistance Systems (ADAS).

<sup>11</sup> <https://odr.chalmers.se/server/api/core/bitstreams/814ab7e3-b5d8-4ce8-b31c-5837bb37b927/content>

<sup>12</sup> <https://www.autoevolution.com/news/how-windshield-water-repellent-products-work-43296.html>

<sup>13</sup> <https://www.carmelowalsh.com/wp-content/uploads/2015/09/lidar-sensor-view-of-the-baias-show-floor-hl.jpg>

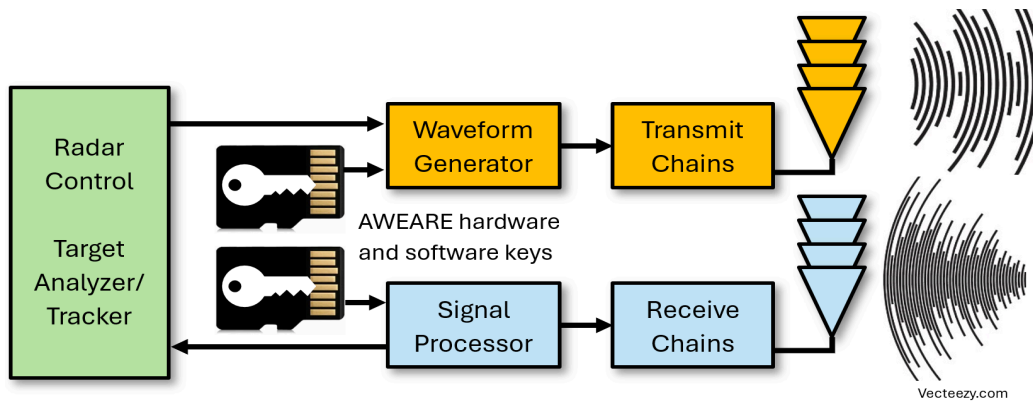

## TECHNOLOGY

In the dynamic landscape of autonomous driving, sensors play a pivotal role in shaping the safety and reliability of self-driving systems. Unfortunately, each existing sensor type comes with its own set of limitations. High-resolution cameras, though inexpensive, struggle in adverse weather and high-contrast light conditions. Laser-based rangefinding LiDARs can have exceptional resolution, but face serious challenges of high cost and susceptibility to bad weather. Radars, conversely, perform very well in adverse weather but have poor resolution and are subject to ghosts/phantoms. Conventional radars do not know which objects are real and which are false, and sometimes critically miss real objects as a consequence.<sup>14</sup>

The importance of improved resolution cannot be overstated, particularly when faced with the challenge of differentiating between highway overpasses and large vehicles as illustrated in the figure<sup>15</sup>, a task that conventional autonomous driving systems have not completely solved.<sup>16</sup> Separately, a reduced false positive rate is crucial for mitigating issues like phantom braking and accurate detection of stationary objects.

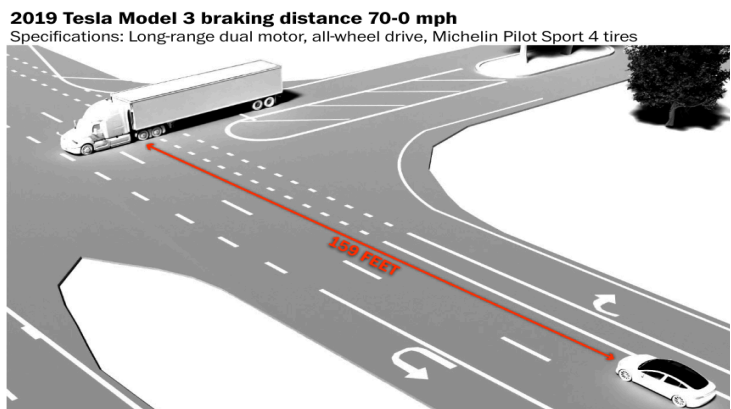

As Wired Magazine reported, industry experts state that ignoring stationary objects is a necessary compromise: "Semi-autonomous systems are designed to ignore unmoving obstacles because otherwise, they couldn't work at all..."<sup>17</sup> However, this compromise has proven dangerous, as seen in well-publicised accidents involving parked vehicles.<sup>18,19,20</sup>



Accidents involving parked vehicles (left<sup>20</sup>) can be prevented through the use of improved sensors. The quest for improvement led AWEARE scientists to pursue methods that combine the strengths of LiDARs and radars without their weaknesses. This entails building upon the cost-effectiveness and all-weather suitability of radar but adding LiDAR's superior resolution while mitigating false positives.

<sup>14</sup> <https://www.wired.com/story/self-driving-cars-uber-crash-false-positive-negative/>

<sup>15</sup> <https://www.washingtonpost.com/technology/interactive/2023/tesla-autopilot-crash-analysis/>

<sup>16</sup> <https://www.idtechex.com/en/research-article/tesla-dropping-radar-was-a-mistake-here-is-why/25619>

<sup>17</sup> <https://www.wired.com/story/tesla-autopilot-why-crash-radar/>

<sup>18</sup> <https://www.cnn.com/2021/08/16/business/tesla-autopilot-federal-safety-probe/index.html>

<sup>19</sup> <https://cleantechnica.com/2019/05/21/teslas-trouble-with-trucks-and-another-shakeup-of-the-autopilot-team-is-there-a-connection/>

<sup>20</sup> <https://www.autoweek.com/news/technology/a1689671/ntsb-probe-autopilot-after-tesla-model-s-rear-ends-parked-fire-truck/>

The breakthrough was first demonstrated in 2016, replicated repeatedly in AWEARE laboratories since 2019, and implemented into prototypes built using low-cost components in 2023. The basic concept behind these technologies is simplified below with a concept waveform image<sup>21</sup>, but the details of how to achieve this in a cost-effective fashion are quite complex and took years to refine:

1. Start with complex engineered waveforms
2. The reflection from each target incorporates additional detail about size, position, and speed into their echoes
3. AWEARE receives and processes the echoes to extract this normally hidden information about the target

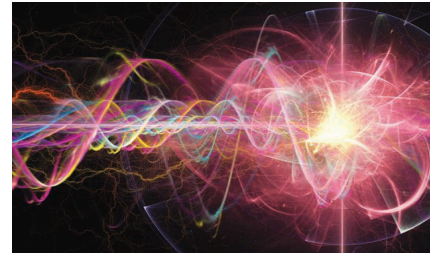

Built on novel hardware, proprietary algorithms, and waveforms protected by patents and trade secrets, AWEARE radar emerges as a promising solution to these challenges. Filed patents cover hardware design, algorithm, method of use. Trade secrets cover hardware design, algorithms, methods of use, and software/code.<sup>22 23</sup> Three independent radar experts from two leading research institutions have verified the AWEARE breakthrough as having the potential to advance the efficiency and safety of existing ADAS systems as being “beyond the current state of the art”, exceeding range/velocity resolution by 2x to 3x and eliminating 80% of ghosts compared to industry-standard frequency-modulated continuous wave (FMCW) radar.

The commitment to ongoing innovation continues with AWEARE's immediate plans to add complementary algorithms that could further improve resolution and reduce the false positive rate, possibly exceeding 95% and realising a truly reliable sensor. The successful integration of AWEARE radar may help pave the way for safe, widespread acceptance of self-driving technology. This may prove to be a transformative step toward realising the full potential of self-driving technology as well as advancing the efficiency and safety of existing ADAS systems.

## COMPETITION

Elaine Herzberg's accident marked a tragic turning point in the development of self-driving cars, revealing persistent challenges that need to be fully addressed. In the aftermath, similar accidents continue to occur, highlighting that critical problems in the industry remain unsolved. These issues include an excess of false positives or ghosts, collisions with stationary objects like parked emergency vehicles, and difficulties in vertical resolution, particularly when discerning between highway overpasses and the sides of trucks.<sup>24</sup>

Self-driving cars rely on sensors, including multiple cameras, LiDARs, and radars working in conjunction with map databases. However, each technology brings advantages and drawbacks. LiDARs with exceptional resolution come with a high price tag and struggle in adverse weather conditions. Conversely, radars perform well in bad weather but suffer from poor resolution and ghosts. To our knowledge, next-generation radar chipset manufacturers have only reported rejection of false positives resulting from interference by nearby radar systems, but have not broken conventional FMCW resolution limits or provided reliable solutions to common ghost sources.

In contrast, three independent experts have witnessed radar demonstrations that verify AWEARE's milestones: 80% ghost reduction and 2x-3x resolution improvement. A verification letter from Professor William Michalson of Worcester Polytechnic Institute (viewable in website) reported the technical results and that AWEARE “is beyond the current state of the art”. These milestones appear unparalleled and may hold the key to resolving persistent self-driving issues.

<sup>21</sup> <https://mtt.org/publications/ieee-microwave-magazine/>

<sup>22</sup> D. Hyman, “Sensor device for driverless vehicles having shrouded slot antenna with high isolation in printed substrates.” USPTO Patent Application.

<sup>23</sup> D. Hyman & M. Hyman, “Sensor device for driverless vehicles having improved elevation resolution.” USPTO Application.

<sup>24</sup> <https://www.idtechex.com/en/research-article/tesla-dropping-radar-was-a-mistake-here-is-why/25619>

## INTELLECTUAL PROPERTY & BARRIER TO ENTRY

AWEARE's milestones stand at the forefront of technology creation, leveraging proprietary signal processing and waveforms safeguarded by patents and trade secrets. For IP protection, the algorithms require hardware signal processing keys that are difficult to reverse engineer or decipher, protecting AWEARE's competitive advantages even after licensing and deployment.

The company has pioneered advancements that enhance resolution, eliminate ghosts, and eradicate interference from neighbouring radar systems. The commitment to innovation is reflected in AWEARE's ongoing efforts to file additional patents in global markets and focus on novel applications and technologies that build upon the fundamentals of electromagnetics.

A core AWEARE strategy is to secure a first-mover advantage by driving widespread adoption through aggressive penetrating pricing at less than 1/3 industry norms. AWEARE can complement the chipsets of leading suppliers such as Infineon, NXP, Imec, STMicroelectronics, Bosch, Analog Devices, and Texas Instruments, as well as innovative startups such as Arbe Robotics, that are already ready for AWEARE augmentation. By offering breakthrough capabilities at attractive financial terms in a software licensing model, AWEARE aims to rapidly gain market share while maintaining the hardware signal processing keys as an additional safeguard for IP. The United States Department of Energy stated the advantage of these safeguard mechanisms is to "protect information in that they are ridiculously complex to reverse engineer".<sup>25</sup> In addition to encryption and zero-izing techniques that protect software and firmware embedded in each product, AWEARE employs a layered protection strategy of patents and licensing to preserve and sustain its market advantages.

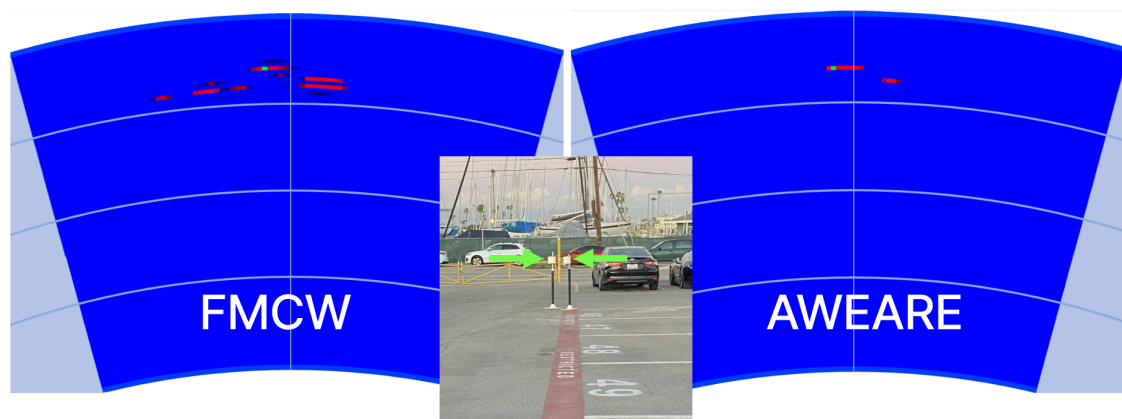

Figure: FMCW radar viewing two adjacent radar targets sees ghosts; AWEARE eliminates these ghosts. Both images were taken with identical hardware at the same filter settings.

The challenge of reducing ghosts is well-acknowledged in the industry, and AWEARE's approach aims to address this issue head-on. For example, Zigang Yang, Senior System Engineer from Texas Instruments, publicly recognized (shown below) the absence of a satisfactory solution for mitigating multipath ghosts in a statement on their own radar chipset support web forum.<sup>26,27</sup>

Beyond AWEARE's milestone demonstration of 80% ghost elimination, additional algorithms have been identified to eliminate even more ghosts in 2nd generation units. As AWEARE progresses in

<sup>25</sup>

<https://www.osti.gov/servlets/purl/1502742#:~:text=The%20chief%20reason%20that%20FPGAs,that%20are%20difficult%20to%20decode>

<sup>26</sup> [https://www.youtube.com/watch?v=\\_My99O7sQ4o](https://www.youtube.com/watch?v=_My99O7sQ4o)

<sup>27</sup>

<https://e2e.ti.com/support/sensors-group/sensors/f/sensors-forum/1038453/iwr6843isk-ods-ghosts-targets-generated-by-wall-reflection>



filing additional patents and expanding its technological capabilities, the company may be poised to play a transformative role in reshaping the technology landscape.

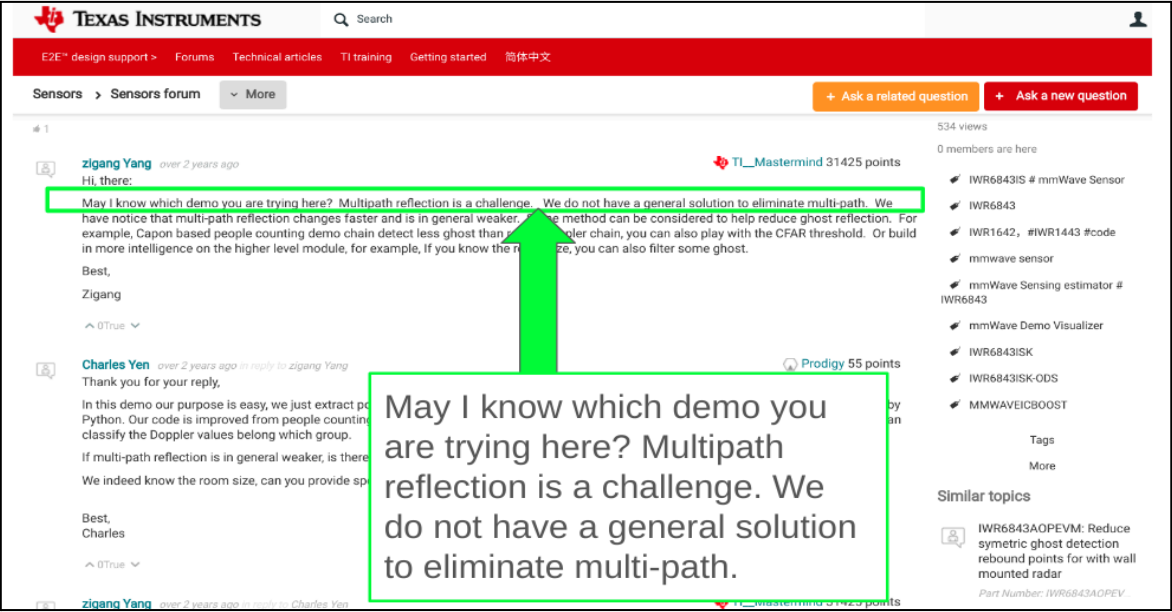

**PROJECTIONS**

Working with BDO (top 5 global accounting network), financial projections for AWEARE Global were developed for a 7-year period strictly focused on discounted revenues in the automotive and light rail sectors. BDO’s letter describes a conservative approach that does not count (at all) the majority of potential applications and results in a present valuation of \$100,000,000 USD. The current blockchain-backed token offering reflects a reduced price that is equivalent to a valuation of \$60,000,000 as tokens do not grant General Assembly participation/voting rights. To encourage early investment, discounts for larger token purchases are offered.

Key automotive applications are advanced driver assistance systems (ADAS) and autonomy. Both public interest to improve safety and private commercial interest may accelerate adoption:

- a. Drawing parallels to airbags and anti-lock brakes, the Biden administration in the United States recently announced plans to require all cars to be able to detect pedestrians in the dark and braking when a pedestrian is detected.<sup>28</sup>
- b. ADAS market leader (~70% market share), Mobileye, may benefit disproportionately from AWEARE’s reduced false positive rates and improved resolution. This potential benefit is due to Mobileye’s design that divides the A.I. processing into 2 parallel systems (camera-based & radar/LiDAR-based), thereby potentially increasing reliance on the accuracy of each sensor.<sup>29</sup> AWEARE is in discussions with two key executives involved in the M&A deal in which Intel acquired Mobileye for \$15 billion in 2017.<sup>30</sup>

Within the automotive sector, recognizing that adoption of new sensors most easily occurs through existing channels, the revenue generation model is focused on licensing to Tier 1 system developers and Tier 2 chipset suppliers. Otherwise, penetrating this highly consolidated market as a new entrant under a hardware manufacturing model would be costly and risky. The software licensing model leverages existing supply chains, and assumes that AWEARE will receive 1% of radar product revenue with a low licence fee and low cost of sales (commission). It should be highlighted that a 1%

<sup>28</sup> <https://www.nbcnews.com/business/autos/new-car-safety-technology-required-in-the-us-what-and-when-rcna149790>  
<sup>29</sup> <https://www.mobileye.com/technology/true-redundancy/>  
<sup>30</sup> [https://www.reuters.com/article/idUSKBN16K0Z4/#:~:text=JERUSALEM%2FDETROIT%20\(Reuters\)%20%2D,driverless%20for%20global%20automakers](https://www.reuters.com/article/idUSKBN16K0Z4/#:~:text=JERUSALEM%2FDETROIT%20(Reuters)%20%2D,driverless%20for%20global%20automakers)

licence fee is deliberately conservative, considering that standard automotive industry IP licensing averages 3.3% of revenues and typical electronics licensing is 5.1%.<sup>31</sup> The projections assume that the aggressive penetrating price strategy will continue with no price increase after penetration reaches 3% by year 6 and 10% by year 7.

The financial model and valuation not only reflect the market potential in the automotive and light rail applications, but also lay the foundation for further exploration of untapped opportunities across diverse industries. With AWEARE continuing to advance its technology and focus on monetization via licensing in the automotive sector, there is potential for even greater returns if the technology becomes more widely adopted across multiple applications.

Light rail is a lower-volume market in which AWEARE has ties with an established partner. Instead of licensing, the algorithms, software, and hardware keys will be bundled and integrated with third-party subsystems and components including processors, A.I., and other sensors to provide a total solution. One partner has provided a letter of interest for such an integrated system, projecting start of sales within 36 months after meeting specifications for false positives, range, and frame rate.



Based on input from MRD, our Shanghai-based partner, initial sales may comprise non-recurring engineering (NRE) and a small scale deployment in a subway system, with the Shanghai Metro system being an ideal customer. Depending on customer preference, radars can be deployed in the front and rear of each subway train and/or both directions in each station of each subway line. A single deployment with coverage of both directions at each station, for example, would represent 50+ units per line, and Shanghai alone has 19 separate subway lines (map in figure).<sup>32,33</sup>

The roll-out plan assumes dozens of units per year, (or one small line of deployment) in years 3 and 4 as validation platforms before wider adoption and volume ramp-up can occur. While large metropolitan systems represent the largest potential market, 41 cities are presently constructing one or more light rail lines across China.<sup>34</sup> Newer subway systems such as the Wuxi Metro system (map lower right) may offer timely opportunities with rapid growth and four new lines presently under construction.<sup>35</sup>

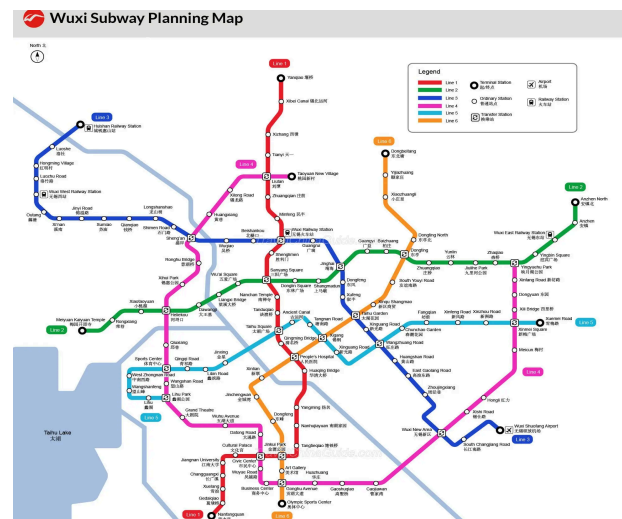

<sup>31</sup>

<https://www.upcounsel.com/patent-licensing-royalty-rates#:~:text=Examples%20of%20average%20royalty%20rates,Automotive%2C%203.3%20percent>

<sup>32</sup> <https://www.quora.com/What-do-you-think-about-the-crowded-trains-in-Tokyo>

<sup>33</sup> <https://shanghaimap360.com/shanghai-metro-map>

<sup>34</sup>

[https://www.scmp.com/news/china/science/article/3255039/china-puts-trust-ai-maintain-largest-high-speed-rail-network-earth?campaign=3255039\\_fb72aed8-e1c9-11ee-8f7d-aac3dc6fa899&module=perpetual\\_scroll\\_1\\_AI&pgtype=article](https://www.scmp.com/news/china/science/article/3255039/china-puts-trust-ai-maintain-largest-high-speed-rail-network-earth?campaign=3255039_fb72aed8-e1c9-11ee-8f7d-aac3dc6fa899&module=perpetual_scroll_1_AI&pgtype=article)

<sup>35</sup> <https://www.travelchinaguide.com/images/map/jiangsu/wuxi-metro.jpg>

AWEARE Global is targeting critical but realistic technology milestones that address the needs of additional future applications in the current financing round. Each vertical represents a high-growth market that may benefit from automation as long as safety concerns. This potential upside is built into the business model, which has AWEARE retaining control of opportunities in trucking, robotics, law enforcement, security, etc. Each application has its own requirements for performance, cost, and system integration, and would require its own team to pursue development into their own product lines even though they are all based on the same enabling technology and software. Their significance in the overall picture, while not counted for valuation purposes, could increase as development and customer engagement milestones are met.

With continued execution and scheduled milestones, AWEARE may be in a favourable position to launch market-specific ventures. If the technology gains wider traction, there is substantial room for rapid growth beyond these assumptions.

## **2.2.2 Principal Activities**

The principal activity of the Issuer is focused into the main area of expertise: radar technology, wave forms, commercial and non commercial applications.

### **Principal Activity of the Issuer**

At the core of our organisation lies a profound commitment to pioneering advancements in radar technology, encompassing both hardware and software development, as well as strategic IPlicensing initiatives. Our primary focus revolves around pushing the boundaries of innovation to redefine the possibilities and capabilities of radar systems across various industries and applications.

### **Innovative Radar Technology Development**

Our journey in radar technology development is marked by relentless pursuit of excellence and innovation. We strive to engineer cutting-edge radar systems that not only meet but exceed the evolving demands and challenges of modern industries. From conceptualization to implementation, our team of experts is dedicated to pushing the boundaries of what is achievable, driving breakthroughs that shape the future of radar technology.

### **Hardware Excellence**

In the realm of hardware development, we set ourselves apart by our unwavering commitment to precision engineering and technological prowess. Through meticulous design and optimization, we engineer radar hardware solutions designed to deliver unparalleled performance, reliability, and scalability. Our hardware innovations are not just products; they are the embodiment of our vision to empower industries with transformative radar technologies. The hardware products are in prototype form and are in development at this time with the anticipated use of funds supporting transition to manufacturing.

### **Software Mastery**

Complementing our hardware innovations is our mastery in software development, where we leverage advanced algorithms and computational techniques to unlock the full potential of radar systems. Our software solutions are not merely tools; they are intelligent, intuitive systems that enable seamless integration, efficient operation, and enhanced performance across a diverse range of applications. From data analytics to machine learning, our software capabilities empower industries to harness the true power of radar technology. The software products are in prototype form and are in development at

this time with the anticipated use of funds supporting application-specific processing, system integration, and encryption.

### **Strategic IP Licensing Initiatives**

Central to our vision is the recognition of the intrinsic value of IP including patents and trade secrets. Through strategic IP licensing initiatives, we aim to not only protect but also leverage our innovative radar technologies to drive collaboration, innovation, and growth. At least one new technology has been identified by the team for filing international patents. These filings have been budgeted in our use of funds and can serve as the baseline for licensing initiatives subject to government export control regulations. This significant investment into our IP assets represents our commitment to safeguarding our technological innovations while fostering a culture of collaboration and partnership in the industry. In view of all these circumstances, there is a certain dependency with regard to IP.

### **Industry Leadership and Collaboration**

As leaders in radar technology development, we are committed to driving industry-wide innovation and excellence. Through strategic collaborations, partnerships, and alliances, we strive to create a vibrant ecosystem of innovation wherein ideas are shared, synergies are explored, and collective progress is achieved. Our commitment to collaboration underscores our belief in the power of collective intelligence and the importance of shared goals in driving technological advancement.

### **Vision for the Future**

Looking ahead, our principal activity will continue to be guided by a bold vision for the future—one characterised by relentless innovation, unwavering commitment to excellence, and a steadfast dedication to pushing the boundaries of what is possible. By remaining at the forefront of radar technology development, we are poised to help shape the trajectory of industries, transform the way we perceive and interact with the world, and unlock new frontiers of human potential.

In summary, our principal activity revolves around the relentless pursuit of excellence in radar technology development, encompassing hardware and software innovation, as well as strategic patent licensing initiatives. With a steadfast commitment to innovation, collaboration, and visionary leadership, we are poised to redefine the future of radar technology and chart new horizons of success and significance.

There are no products or services developed by AWEARE Global during the historical period. The U.S. partner AWEARE Technologies, Inc. developed a radar demonstrator during this period that was shown to radar experts and strategic partners and validated the technical achievements described herein.

## **2.2.3 Business Strategy**

### **USE OF FUNDS**

Having verified fundamental technology advantages, AWEARE is now focusing on application-specific demonstrations and methodical enhancements. AWEARE will initially pursue automotive and light rail applications for advanced demonstrations towards negotiating licensing agreements with Tier 1 and Tier 2 electronics suppliers as well as autonomous vehicle OEM developers. To expedite commercial acceptance in these industries, AWEARE will demonstrate its technology using the same chipsets used by these target customers.

AWEARE will be focused on planned radar enhancements including additional signal processing algorithms for further ghost minimization and resolution improvement.

- a. Advance from prototype to product development



- b. Enhance range and signal processing for full-speed imaging

Sensor fusion with high-resolution cameras allows AWEARE to create a complete aftermarket product for light rail. Sensor data will be ported to self-driving control software for road and rail demonstrations. To reduce engineering time, the team will leverage third-party sensor fusion software packages such as LeddarVision illustrated below.<sup>36</sup> The price for light rail products is high and can accommodate such third-party A.I. licensing fees. The integration effort will be led by development partners who already sell products in this space and interface with customers such as municipal governments and rolling stock manufacturers.

- c. Release sensor fusion module for light rail
  - a. Mount systems and gather road/rail data for real-world training



The current round of financing provides AWEARE with the opportunity to forge connections with potential customers in other follow-on verticals. To ensure the core team remains focused on advancing primary automotive and light rail opportunities, preselected development partners will conduct concept demonstrations in these verticals with technical guidance from the AWEARE team:

- a. Trucking specifications requiring specialised radar frequencies for longer range
- b. Law enforcement specifications requiring specialised radar frequencies
- c. Robotics requiring specialised radar frequencies for higher resolution and smaller size

In the last three years, these partners have a consistent track record of on-time delivery and meeting AWEARE specifications. Beyond confidentiality agreements, technical information will be compartmentalised for IP protection.

## 2.2.4 Principal and Potential Markets

AWEARE is focusing on two primary sectors: Automotive and Light Rail.

For the Automotive sector, the key geographical markets include Asia, North America, and Europe. Within Asia, AWEARE will employ a targeted approach due to the region's diverse industry landscape and the unique partnerships of each automotive company.

<sup>36</sup> <https://leddartech.com/about-leddartech/>

In the Light Rail sector, the primary focus will be on Asia and Europe, with other regions considered secondary or tertiary based on the presence of leading global innovators in sensor and automation technology adoption.

All business operations and sales activities will strictly adhere to U.S. export control laws, as well as comply with the relevant regulations of each country involved.

Potential markets include all civilian (non-defense) transportation (including automotive, trucking, rail, light rail, high speed rail, aircraft anti-collision, and marine), robotics, law enforcement, security, presence monitoring, consumer electronics, construction, infrastructure, banking, mining and agriculture applications.

AWEARE does not own any rights to defence/ITAR-restricted applications.

AWEARE owns the exclusive rights to its radar technology in these following fields:

**Automotive Industry Including Trucking:**

- Self-driving: Radar sensors are critical for operation in inclement weather to improve the safety and reliability of self-driving vehicles.
- Adaptive Cruise Control (ACC): Radar sensors help maintain a safe distance between vehicles by adjusting the speed automatically.
- Collision Avoidance Systems: Radar aids in detecting obstacles and issuing warnings or initiating automatic braking.
- Blind Spot Detection: Radar detects vehicles in blind spots, enhancing overall road safety.

**Rail Transportation:**

- Train Control Systems: Radar contributes to train control systems for maintaining safe distances between trains and preventing collisions.

**Aviation:**

- Collision Avoidance: Radar helps detect nearby aircraft, contributing to air traffic control and collision avoidance systems.

**Maritime and Navigation:**

- Navigation Radar: Essential for ships to detect other vessels, obstacles, and coastlines.
- Collision Avoidance: Radar aids in preventing collisions at sea, especially in low visibility conditions.
- Docking: Automated docking and pilot-assistance systems can mitigate challenges for crewed and uncrewed vessels.

**Government and Security:**

- Surveillance Radar: Used for border security, law enforcement, and monitoring activities in government and security operations.
- Target Tracking: Radar helps track and identify moving objects for enhanced physical security .
- Through-Wall Radar: Law enforcement and other government applications.

**Agriculture:**

- Precision Agriculture: Radar is used for soil moisture measurement, crop monitoring, and harvested crop size measurement.
- Navigation and Safety: Radar provides autonomous and farmer-assistance sensing of terrain, obstacles, and animal/person detection.

#### **Infrastructure Monitoring:**

- Building Structural Health Monitoring: Ground-penetrating and through-wall radar can be used to assess the condition of infrastructure such as bridges and buildings.
- Warehouse, Retail, Banking and Security: Presence-monitoring and intruder detection.

#### **Robotics:**

- Obstacle Avoidance: Radar sensors contribute to the development of robots capable of navigating and avoiding obstacles in various environments.

#### **Consumer Electronics:**

- Smartphones and Wearables: Some consumer devices incorporate radar technology for gesture recognition, vital sign monitoring, and presence detection.

#### **Mining Industry:**

- Collision Avoidance: Radar is employed to enhance safety by detecting obstacles and preventing collisions in mining operations.

These examples showcase the versatility of radar technology across diverse industries, highlighting its role across safety, navigation, monitoring, and law enforcement applications. Ongoing technological advancements continue to expand the potential applications of radar in different sectors.

### **2.2.5 Exceptional Influences**

Beyond material science, raw materials, commercial available hardware, and geopolitical risks, a radar startup should also consider the following exceptional influences that can significantly impact their operations and success:

**Regulatory Compliance:** Adherence to international and local regulations is crucial in the development and deployment of radar technology. Regulatory frameworks may vary across industries, and staying compliant is essential for market entry and sustained growth. Industry standards set by government and industry bodies can affect product acceptance.

**Cybersecurity Concerns:** As radar systems become more interconnected and integrated into larger networks, the risk of cyber threats increases. Ensuring robust cybersecurity measures to protect against hacking, data breaches, and unauthorised access is paramount, especially when dealing with sensitive applications like surveillance.

**Technological Advancements:** Rapid advancements in technology can both benefit and disrupt the radar industry. Staying abreast of the latest technological trends, such as artificial intelligence, machine learning, and data analytics, can provide a competitive edge. Conversely, failure to adopt emerging technologies may lead to obsolescence.

**Supply Chain Disruptions:** Dependencies on specific suppliers or regions for critical components can expose a startup to supply chain risks. Disruptions, whether due to natural disasters, geopolitical

tensions, or global events (as seen with the COVID-19 pandemic), can impact production timelines and costs.

**Intellectual Property Protection:** In a competitive market, protecting intellectual property (IP) is essential. Startups should be vigilant about patenting their innovations and establishing legal safeguards to prevent unauthorised use or replication of their radar technology. Non-practicing entities (NPEs, a.k.a. “patent trolls”) represent a litigation risk for any technology company. It is also possible that one or more external patents can be missed during IP audits.

**Market Trends and Customer Preferences:** Understanding evolving market trends and aligning products with customer preferences is vital for sustained success. Being adaptable to changes in user demands, industry requirements, and emerging applications ensures continued relevance and market penetration. This includes the potential for consumer preferences in favour of or against automation which has the potential to influence policy at the industry or government regulations level.

**Environmental Impact:** Increasing awareness of environmental sustainability may influence industry preferences and regulations. Startups should consider the environmental impact of their radar technology, exploring ways to minimise energy consumption, waste, and ecological footprint.

**Collaborations and Partnerships:** Forming strategic collaborations with industry partners, research institutions, and other stakeholders can enhance a startup’s capabilities. Collaborations can lead to shared resources, expanded expertise, and accelerated development timelines.

**Public Perception and Ethical Considerations:** Public perception and ethical considerations play an increasingly significant role, especially in government applications. Addressing ethical concerns, ensuring transparency, and engaging in responsible practices can contribute to a positive public image. Inconvenience and accidents caused by autonomous vehicles may negatively impact public sentiment and possibly influence regulatory response.

**Global Economic Conditions:** Economic fluctuations and geopolitical events can impact market demand, funding opportunities, and the overall business environment. A radar startup should be attuned to global economic conditions to make informed business decisions.

By proactively addressing these exceptional influences, radar startups can navigate challenges, capitalise on opportunities, and build a resilient foundation for long-term success in a dynamic and competitive industry.

## 2.2.6 Competitive Position

### **AWEARE Global AG: Redefining Radar Technology with a Competitive Edge**

In the realm of radar technology, AWEARE Global AG stands out as a clear leader, leveraging a wealth of experience and expertise to revolutionise the industry. Since its inception in 2017, AWEARE has been spearheaded by seasoned professionals, including notable figures such as the principal inventor of the DRONEKILLER® deployed worldwide and the former Division Chief Engineer of Major Program/Business Segment of Boeing Defense, Space, & Security as well as Rockwell Collins/BAE Aerospace Electronics Systems Division. These industry veterans bring a rich history of accomplishments and leadership.

### **Leadership with a Proven Track Record:**

The leadership team at AWEARE brings decades of collective experience and a proven track record of success in some of the most critical aerospace and government projects. With roles spanning from directorship and program management to engineering leadership, the team has been instrumental in driving innovation and delivering cutting-edge solutions across a spectrum of programs, including commercial aircraft modification, advanced government programs, and more. Their extensive experience leading teams of up to 1,000 engineers, technicians, and operators encompasses nearly every facet of electrical and aerospace engineering, avionics, software integration, and technology development, underscoring their deep understanding of complex systems and mission-critical (safety) applications.

#### **Innovating Beyond the Status Quo:**

AWEARE's competitive advantage lies in its ability to innovate beyond the status quo as verified by three independent radar experts from two leading American research universities. While other companies may invest in flashy marketing campaigns to boast incremental or marginal improvements in traditional product lines, AWEARE has instead focused on addressing fundamental critical challenges that have been largely unresolved by the industry. The team's unique insight and expertise have led to the development of groundbreaking solutions aimed at removing ghosts—an issue that has plagued autonomous driving systems and radar applications for many years.

#### **Unprecedented Technological Breakthroughs:**

AWEARE's technology represents a paradigm shift in radar systems, offering unparalleled resolution and ghost reduction capabilities that have eluded other industry players. Through a combination of proprietary algorithms, waveform engineering, and signal processing techniques, AWEARE has achieved a level of performance that surpasses conventional radar systems. Independent experts and leading radar Ph.D.s have verified the capabilities of AWEARE's technology, being beyond the current state of the art.

#### **Addressing Industry Challenges Head-On:**

One of the key strengths of AWEARE lies in its proactive approach to directly addressing industry challenges. While other companies may not have tackled complex technical issues, AWEARE embraces them as opportunities for innovation and differentiation. By focusing on solving fundamental problems like resolution and ghost reduction, AWEARE has positioned itself as a trailblazer in the radar technology space, paving the way for safer, more reliable autonomous systems.

#### **Strategic Advantage in Existing Hardware Compatibility:**

Another significant advantage of AWEARE's technology is its compatibility with existing hardware chipsets, allowing for straightforward hardware key integration and forward-compatible upgrades. This compatibility opens up new possibilities for dramatically reducing time to market for AWEARE's innovative solutions. By leveraging existing high-volume supply chain infrastructure and manufacturing technologies, AWEARE offers a cost-effective and efficient path to achieving autonomous driving capabilities.

#### **Expertise in Geopolitical Risk Management:**

In addition to its technical prowess, AWEARE boasts expertise in geopolitical risk management—a critical aspect of operating in the global marketplace. With a decentralised team spanning global roots in locations like Liechtenstein, Singapore, India, and California, AWEARE is well-positioned to navigate geopolitical complexities and adapt to changing market dynamics. The team's experience in managing multi-billion-dollar businesses with decentralised structures underscores their ability to mitigate risks and capitalise on opportunities across diverse environments.

#### **Conclusion:**

In summary, AWEARE Global AG stands at the forefront of radar technology innovation, driven by a leadership team with a proven track record of success and a determined commitment to pushing the boundaries of what is possible. With groundbreaking technological breakthroughs, a proactive approach to addressing industry challenges, and expertise in geopolitical risk management, AWEARE is poised to help shape the future of radar technology and lead the way towards safer, more reliable autonomous driving systems and radar applications.

## 2.3 Investments

As the Issuer is a newly established company incorporated in 2023, it has not made any material investments in previous financial years. Therefore, there are no historical financial reports or material investments to report for the period covered by the historical financial information up to the date of this registration document.

However, significant investments have been made by the Issuer's affiliated company, **AWEARE Technologies Inc.**, which has been operating since 2017 in the United States. These investments have been instrumental in the development of the radar technology and have facilitated the establishment of an exclusive sales agreement with the Issuer. This agreement grants the Issuer the exclusive rights to market and sell the radar technology in specified sectors.

The following major investments have been made or are in progress or have been decided:

**Embrace the Future:** Our commitment to Research & Development (R&D) stands at the forefront, representing a substantial 41% of our anticipated use of funds. Delving into specific technical domains, we are poised to revolutionise the landscape, with each step rooted in a rich history of innovation.

**From Concept to Reality:** Our visionary team embarked on a transformative mission, conceiving the redesign and reengineering of radars, setting the stage for a paradigm shift. This journey traces back before 2016, where theoretical proof laid the foundation for our ambitious endeavours. The prospect of enhanced resolution and minimised anomalies sparked a revolution that can redefine radar markets.

**Pioneering Progress:** Fast forward to 2016, where feasibility transitioned from theory to tangible reality, marking a pivotal milestone in our quest. With rigorous engineering and new intellectual property, we brought forth a novel radar demonstrator with the potential to disrupt conventions and set new standards.

**Practical Demonstrator:** The year 2020 witnessed another critical milestone of our journey as we showcased proof of concept using automotive-grade components. This pivotal moment not only validated our vision but also set us up on the path to commercialisation.

## 2.4 Trend information

### Radar Systems Market: A Wave of Innovation and Growth

#### Market Dynamics:

The Radar Systems Market is poised for exceptional growth, with an estimated global market size of USD 34.18 billion in 2024, projected to reach USD 45.08 billion by 2029.<sup>37</sup> The forecasted Compound Annual Growth Rate (CAGR) of 5.69% (2024-2029) highlights the industry's robust trajectory. Radar technology, renowned for its applications in meteorology, surveillance, maritime, and automotive

---

<sup>37</sup> [Radar Systems Market - Size, Forecast & Demand \(mordorintelligence.com\)](https://www.mordorintelligence.com)

sectors, continues to evolve, fueled by advancements such as laser radar (LiDAR), machine learning, and increased levels of chipset integration.

#### **Global Trends:**

**Automotive Revolution:** With a surge in investment by automobile companies in autonomous driving solutions, the demand for automotive hardware products, including radar, cameras, and safety sensors, is on the rise. Hyundai's radar-based rear occupant alert system is a testament to innovations in passenger safety as novel applications emerge in traditional markets.

**Government and Security:** Rising global spending on government and security services has propelled the demand for A.I.-supportive technologies.

**Challenges Post-COVID-19:** The COVID-19 pandemic impacted the world economy and government budgets, affecting radar system demand. Countries re-evaluated security investments, leading to increased radar deployment and international collaborations.

**Interdisciplinary Integration:** The fusion of radar with other sensing technologies, such as video cameras and LiDAR, requires a nuanced understanding of product architectures. The diverse contexts in which automobile radars operate demand meticulous attention to waveform design, frequency configuration, and transmission frame size.

#### **Market Trends:**

**Automotive Application Boom:** The automotive sector is set to experience significant growth, driven by the increasing adoption of self-driving, Advanced Driver-Assistance Systems (ADAS), and Internet of Things (IoT). Adoption may be further accelerated by governmental action, as the Biden administration in the United States recently announced plans to require all cars to be able to detect pedestrians in the dark and braking when a pedestrian is detected. The anticipated reduction in accidents, insurance premiums, and consumer safety fuel a projected USD 80 billion market for autonomous driving hardware by 2030.<sup>38</sup> These projections underscore the transformative global impact of radar technology.

**Imaging Radars:** Imaging radars are gaining prominence in automotive, industrial, civil, and meteorological systems. ADAS imaging radar has higher precision and provides capabilities of collision avoidance, multi-lane tracking, and parking aids as pivotal contributors to automotive safety.

**North America's Dominance:** North America is witnessing remarkable growth, especially in government and security spending, making it a key market for radar systems in non-consumer markets. The deployment of Long Range Discrimination Radar (LRDR) and strategic investments, such as Canada's USD 1 billion plan for border radar coverage exemplifies the region's commitment to advanced sensor technologies.

#### **Key Players:**

Multiple major players are driving innovation and shaping the industry landscape across the consumer, industrial, infrastructure, and government markets. Consumer markets depend on automotive Tier 1 and Tier 2 suppliers to provide radar sensor products and enabling chipsets for the next generation of driver assistance capabilities. Radar manufacturers such as Aisin Seiki, Autoliv, Bosch, Delphi, Denso, and Continental represent a key potential customer base for AWEARE Global for licensing our

---

<sup>38</sup>

<https://www.mckinsey.com/industries/automotive-and-assembly/our-insights/autonomous-drivings-future-convenient-and-connected>

technologies. They are constantly being challenged by the major automotive manufacturers to improve their performance and ADAS integration. Radar chipset developers such as Infineon, NXP, Imec, STMicroelectronics, Bosch, Analog Devices, and Texas Instruments may represent suppliers and potential partners to AWEARE Global rather than competitors, as they are a key part of the tiered supply chain ecosystem.

Higher end infrastructure markets rely on the sensors and integrated control/response systems from companies such as Leonardo S.p.A., General Dynamics Corporation, BAE Systems plc, and Airbus. These suppliers are at the forefront of developing radar technologies and systems such as air traffic control, weather monitoring, and maritime surveillance. These companies compete fiercely in the civilian sector, continuously striving to develop and provide cutting-edge sensing solutions that meet the evolving needs of industry and government customers. Additionally, while Northrop Grumman and Raytheon are prominent players in government sales, they also play a significant role in shaping civilian radar technologies through critical infrastructure projects and commercial deployments.

#### **Recent Developments:**

**Mobileye-Wistron NeWeb Partnership:** Mobileye's partnership with Wistron NeWeb Corp. (WNC) for developing software-defined imaging radars signifies a technological synergy that promises a comprehensive, four-dimensional image of a vehicle's environment.

**Google-Ford Collaboration:** Google's collaboration with Ford to develop an open and standardised Application Programming Interface (API) for automotive radar systems underscores the industry's commitment to interoperability and accelerated application rollout.

**Uhnder and Arbe Robotics 4D Imaging Radar:** Two startups have launched 4D digital imaging radar chipsets for ADAS and autonomous vehicles. Each company promises improved radar accuracy and elevation data for enhanced object detection and driver safety.

#### **Market Insights:**

As we navigate the dynamic landscape of the radar systems market, embracing technological innovations, strategic collaborations, and global trends is pivotal. Our commitment to understanding market dynamics and pioneering solutions ensures a resilient and forward-looking approach, driving our collective success.

#### **Discover the Future of Radar Technology:**

AWEARE is unlocking possibilities, affirming safety, and shaping industries. As stated and documented from a leading university in the US: "To our knowledge, this achievement stands alone in automotive radar technology and is a result of AWEARE's unique signal processing methods."<sup>39</sup>

## **2.5 Profit forecasts or estimates**

The Issuer does not make any profit forecasts or estimates.

## **3. Risk Factors**

---

<sup>39</sup> These basic signal processing techniques include analog filtering using passive and active components as well as digital filtering. We also pointed out the need to be mindful of aliasing (i.e., the presence of spurious signals if the original signal is not properly sampled).



Every investment in securities is associated with risks and its value is subject to operational and market-related fluctuations. General investment risks may include currency, technology, market, competition, transfer, country, liquidity, creditworthiness, interest rate, price and credit risks as well as political, legal and tax risks. This also applies to the securities offered on the basis of this Prospectus (including any supplements).

The securities being offered are participation certificates of the Issuer which are issued in the form of tokens). Participation certificates are securities which represent a certain participation in the Issuer. Tokens are book-entry securities which are issued and transferred to a decentralised database (blockchain).

The return on investments in the AWEARE Global Tokens is composed of potential dividend payments and price gains/losses of the AWEARE Token and cannot be predicted with certainty. The dividend is the profit of the Issuer distributed by resolution of the General Meeting of the Issuer.

Investors are required to read the full Prospectus (including any supplements). The information contained in this Prospectus (including any supplements), in particular the information in the section "Risk Factors", should be considered by any potential investor prior to subscription or purchase of the AWEARE Global Tokens.

There are various risks associated with the subscription and holding of the AWEARE Global Tokens. In accordance with the legal requirements of Regulation (EU) 2017/1129, risk factors are only addressed in this Prospectus (including any supplements) to the extent that they are risks which, in the opinion of the Issuer, are specific, material, and confirmed for the Issuer and the securities. Indeed, it is prohibited to include risk factors in prospectuses which serve exclusively to exclude liability. Thus, the Issuer does not guarantee that the risks described in the section "Risk Factors" are comprehensive and complete and that no further or different risks may arise. It is expressly pointed out that in individual cases further individual risks may occur. Furthermore, risks may occur not only individually but also cumulatively.

It is not sufficient to read and understand the risk factors. Potential investors should be aware of the risks associated with an investment in the Tokens and should not make an investment decision until they have obtained comprehensive advice from their legal, tax, technology, market, and financial advisor, auditor, or any other expert regarding the suitability of an investment in the Tokens, taking into account their personal financial and tax situation and other personal circumstances and the information contained in this Prospectus (including any supplements).

The occurrence of one or more of the risks listed in the section "Risk Factors" may have a material adverse effect on the assets and liabilities, financial position, and/or results of operations and the business of the Issuer in general, which in turn may have a direct effect on the value of and income from the Token. It is recommended that investors have a sound knowledge and experience of how blockchain, smart contracts, and crypto currencies work before purchasing the Token.

Investors must decide for themselves whether an investment in the AWEARE Token is appropriate for them. In particular, each investor should

- have sufficient knowledge and experience to fully evaluate the Token and the benefits and risks of investing in the Token and the information contained in this Prospectus (including any supplements);
- have sufficient financial resources and liquidity to bear all risks associated with the investment;
- fully understand the terms and conditions of this Prospectus (including any supplements) and be aware of trends and developments in relevant financial market indicators;

- be able, alone or with the assistance of an advisor, to evaluate possible scenarios of economic trends, interest rates and other factors that may affect the investment in the Token and the investor's ability to bear potential risks.

Investors bear the risk that an investment in the AWEARE Token may not be appropriate for them.

**Investors could lose all or part of the capital invested (TOTAL LOSS RISK).**

### 3.1 Risks faced by the Issuer

	Risk Level	Risk category
<p><b>Low capital</b></p> <p>The Issuer's purpose is the commercialisation of the AWEARE's technology. The Issuer's equity capital is limited to USD50,000.00, where the minimum capital required under Liechtenstein law is USD50,000.00. As the Issuer was incorporated on 30/11/2023, no significant historical financial data or key figures, other than the historical financial information referred to in section 2.2.1 of this summary, are available to assess the financial situation of the Issuer in relation to the past years. The Issuer is not subject to an ordinary audit and does not have an audit review. The Issuer has not been evaluated by a rating agency. Low equity capital represents an increased risk for the investor, as the function as liable capital is correspondingly reduced.</p>	high	Finance Risks
<p><b>Insolvency risk</b></p> <p>In the event of the opening of insolvency proceedings over the assets of the Issuer, the Issuer will be temporarily or permanently limited in disposals of its assets, or dispositions of assets of the Issuer will be taken over by a court appointed insolvency administrator. This may have a negative impact on the financial position and the business activities of the Issuer. This case can occur even if insolvency applications were filed incorrectly. In the event of insolvency of the Issuer, the Tokenholders are liable with their invested capital. The invested capital is to be treated as equity and is therefore qualifiedly subordinated. Insolvency can affect access to exclusive technology.</p>	medium	Finance Risks
<p><b>Human error with smart contracts</b></p> <p>The Issuer assumes no liability and makes no representations or warranties as to the functionality of the Issuers project or of any smart contracts that may be programmed or used for the settlement of the offering in accordance with this Prospectus in the broadest sense. Investors may suffer impairments as a result or generally face a total loss. However, in such scenarios, legal mechanisms may apply to protect an investor from loss.</p>	medium	Technical Risks
<p><b>Additional requirements for capital</b></p> <p>The Issuer's capital requirements depend on numerous factors. Depending on the Issuer's ability to generate income from its operations, the Issuer may require further financing in the future. Any additional</p>	low	Finance Risks

<p>equity financing will dilute shareholdings, and debt financing, if available, may involve restrictions on financing and operating activities. If the Issuer is unable to obtain additional financing as needed, it may be required to reduce the scope of its operations and scale back AWEARE product development as the case may be.</p>		
<p><b>Transaction costs</b> Transaction costs may arise in the operations of the Issuer. For example, by exchanging different crypto currencies, which reduces the available investment volume. Transaction costs weigh on the return of the investment. Fortunately, the majority of funds raised are expected to be from crypto currencies tied to fiat currency, so the magnitude of exchange expenses and future change in value of these currencies is comparatively easy to predict and account for in budgeting.</p>	low	Finance Risks
<p><b>Risk from existing influence of ordinary shareholders</b> There are risks stemming from the controlling influence of the current ordinary shareholders, especially during the Issuer's General Meetings. Since the Tokenholders have limited voting rights from the beginning, ordinary shareholders can significantly affect the voting outcomes.</p>	low	Corporate Risks
<p><b>Jurisdictional Liability Risk</b> As an entity engaging with potential United States (US) investors or conducting business within the US, there exists a significant exposure to legal proceedings and lawsuits in US jurisdictions. Despite the merit of any claims, the litigious nature of the US legal system may subject the company to costly and time-consuming legal battles, including class-action lawsuits, regulatory investigations, and other forms of legal scrutiny. Even unfounded claims can result in substantial legal expenses, reputational damage, and diversion of management resources, potentially impacting the company's financial stability and strategic objectives. It is essential for investors to recognize and assess this inherent risk when considering investment opportunities involving US exposure. Failure to comply with these requirements may subject investors to legal ramifications, including potential criminal and civil actions. The issuer will rigorously enforce its legal protections to mitigate the risk of frivolous lawsuits or regulatory challenges. It is imperative for investors to adhere to these protocols, as non-compliance could result in adverse consequences for both the investor and the issuer. Prospective investors should carefully consider these measures when evaluating the investment opportunity and their willingness to adhere to regulatory obligations in the US jurisdiction.</p>	medium	Corporate Risks
<p><b>Risks associated with blockchain technology</b> The Issuer uses blockchain technology, which is associated with some risks. This is mainly due to the fact that it is a relatively new technology, for which no long-term studies and trials have yet been carried out. The Issuer bears the risk of technical difficulties in connection with the blockchain. Actions taken by financial market regulators or other government agencies could result in the closure of crypto exchanges and/or an enforced de-listing of instruments. This kind of action would most likely result in a sharp reduction of traded volume, leading to significantly lower market prices.</p>	low	Technology Risks

<p>The state of the underlying Ethereum blockchain regularly changes even after a block has been mined (uncle blocks). This might even happen after many blocks have been mined. Therefore, the Issuer takes no responsibility for the finality of any blockchain-based events, including the transfer of tokens.</p>		
---	--	--

### 3.2 Risks faced by the Issuer' Business

	Risk Level	Risk category
<p><b>Non-Compliance with Export Control Regulations</b> Failure to comply with domestic and international export control regulations, such as ITAR in the United States, could result in substantial fines, penalties, legal actions, and reputational damage to the company. Non-compliance can affect access to exclusive technology.</p>	medium	Corporate Risks
<p><b>Regulatory Uncertainty and Changes</b> Changes in export control laws and regulations, including updates to technology control lists, may adversely affect the company's ability to export radar technology, leading to potential disruptions in operations and revenue streams.</p>	medium	Corporate Risks
<p><b>Reliance on Government Approvals</b> The company's business operations are dependent on obtaining necessary government approvals and licences for the export of radar technology. Delays or denials in securing these approvals could hinder the company's ability to fulfil contractual obligations and pursue growth opportunities.</p>	medium	Corporate Risks
<p><b>Market Access Limitations</b> Restrictions imposed by export control regulations may limit the company's access to certain geographical markets, thereby reducing the addressable market size and potentially hindering competitive positioning and revenue growth. Companies, particularly Tesla, have tried to eliminate sensors such as LIDAR and radar, and industry vertical integration and partnerships could also affect market access.<sup>40</sup></p>	medium	Corporate Risks
<p><b>Costs and Administrative Burdens of Compliance</b> Compliance with export controls entails additional costs and administrative burdens, which may increase operational expenses and diminish profitability. This could place the company at a competitive disadvantage compared to peers operating in less regulated environments.</p>	medium	Corporate Risks
<p><b>Risk of Unauthorised Technology Transfer</b> There is a risk of inadvertent technology transfer or unauthorised access to sensitive radar technology, particularly through joint ventures, partnerships, or supply chain relationships. Such occurrences could</p>	medium	Corporate Risks

<sup>40</sup>

<https://www.forbes.com/sites/bradtempleton/2022/10/31/former-head-of-tesla-ai-explains-why-theyve-removed-sensors-others-differ/?sh=6e2ea9d24ba8>

compromise intellectual property rights and damage the company's competitive advantage.		
<p><b>Revenue and Operational Disruptions</b></p> <p>Restrictions imposed by export control regulations may disrupt revenue streams and operational capabilities by limiting the company's ability to sell or transfer radar technology to certain customers or partners. Additional restrictions, operational disruptions, and/or licensing fees may need to be paid to hidden patent holders/non practising entities. Separately, licence fee for defence/ITAR restricted applications has not been finalised. This could result in lost sales opportunities and decreased profitability.</p>	medium	Corporate Risks
<p><b>Continuous Monitoring and Adaptation</b></p> <p>The company must continually monitor regulatory developments and adapt compliance practices accordingly to ensure ongoing alignment with export control requirements. Failure to do so may expose the company to heightened regulatory scrutiny and enforcement actions.</p>	medium	Corporate Risks
<p><b>Business financing</b></p> <p>There is no minimum capital to be raised. There is no placement guarantee, but rather the risk is that AWEARE Global Tokens may not be fully subscribed (placement risk). If the Issuer does not succeed in soliciting the desired issue volume, the Issuer will be able to invest less for technology and business development activities. The risk therefore manifests as a risk of a capital shortfall for the Issuer. In addition, the emission costs, which are independent of the amount of capital raised, will remain, which will increase the expense ratio in relation to the total investment capital raised. There is a risk that in this case the Issuer will not achieve its intended investment objectives and will not be able to meet its proposed milestones under the AWEARE Global Tokens. In the event AWEARE Global Tokens are not fully subscribed, milestones will be reduced in number and scope to ensure technology and business development progress can still be made in a reduced breadth of applications, albeit with reduced or delayed equivalent ROI.</p>	high	Finance Risks
<p><b>Management, technology, third party service provider reliance, competition and development timeframes</b></p> <p>One of the Issuer's key strengths is its astute use of the latest radar technology. However technical advantages in the automation and radar technology industry may be short lived. Accordingly, the Issuer's success will depend, in part, on its ability to manage and expand its services and grow its user base to generate revenue quickly to capitalise on first-mover advantages. Changing technologies, users, and third-party service providers' demands and competitive pressures could present future competition and revenue challenges that do not presently exist. Failure or delays in achieving milestones may adversely impact the success of the Issuer. In recognition of this risk, Issuer has developed an aggressive milestone schedule that permits additional growth and fundraising to accelerate commercialization in specific market verticals as Issuer gains traction in certain applications.</p>	medium	Corporate Risks
<b>Execution Plan Variability Risk:</b>	medium	Corporate Risks

<p>As a dynamic startup operating in a rapidly evolving market, the issuer acknowledges the inherent uncertainty associated with executing business plans. While every practicable effort is made to plan and implement strategies, it is anticipated that unforeseen factors, market dynamics, or operational challenges may necessitate adjustments to the plan. These changes could range from minor adjustments to significant strategic pivots, impacting the trajectory and outcomes of the business. The issuer may, from time to time, revise its business plan, including but not limited to product development timelines, marketing strategies, distribution channels, and financial projections in response to changing market conditions, competitive pressures, regulations, supply chains, or other factors. Such modifications may occur without prior notice and could result in material or non-material alterations to the company's operations, financial performance, and strategic direction. While the issuer endeavours to make informed decisions in the best interests of all stakeholders, there can be no assurance that such changes will yield favourable outcomes. Investors should be aware that the nature of startup ventures inherently involves risk and uncertainty, and plans may not always unfold as initially anticipated. By investing in the issuer, investors acknowledge and accept the potential for variability in execution plans and agree to assess investment decisions with a forward-looking perspective, considering the issuer's ability to adapt and respond to evolving circumstances.</p>		
<p><b>Market adoption cost risk</b>  The advantages offered by Issuer to initial markets are higher quality sensor data in both resolution and reduced false positives (ghosts). These advantages come with an attendant cost of additional hardware keys and software licensing fees (paid to Issuer). There is a risk that the market will not accept the additional costs for improved safety. To offset this risk, Issuer has assumed an intentionally low licensing fee structure to reduce perceived disruption and implementation costs. Other technical interface work is also performed to ensure a minimum of system integration overhead is required by customers.</p>	medium	Economic Risks
<p><b>Market adoption speed risk</b>  A separate but related risk is the tolerance for rapid implementation of Issuer's technology. In certain automotive segments, for example, new sensors must be fully vetted and in production for three years (sold to other market segments with field data) before being allowed to be used on a consumer vehicle. This speed of adoption represents a significant unknown for the ramp of revenue as provided in the projections. As a result of this risk, early adoption assumes use in industrial vehicles with non-recoverable engineering contracts which may represent the majority of early sales revenue. This approach is as expected and used by other sensor and automation companies in the automotive industry. Mishaps by autonomous vehicles can negatively impact public opinion and government regulations. Ride-sharing trends may also affect adoption.</p>	medium	Corporate Risks
<p><b>General economic climate</b>  Factors such as inflation, currency fluctuation, interest rates and supply and demand have an impact on operating costs, material costs, and share prices. The Issuer's future revenues and securities price may be</p>	medium	Economic Risks

<p>affected by these factors, which are beyond the Issuer's control. The directors make no forecast in regard to:</p> <ul style="list-style-type: none"> <li>• The future demand of the Issuer's services;</li> <li>• The level of future spending on autonomous vehicles, sensors, and related products world-wide;</li> <li>• General financial issues which may affect policies, exchange rates, inflation and interest rates;</li> <li>• Deterioration in global economic conditions, possibly leading to reductions in revenues and/or spending which could have a corresponding adverse impact on the Issuer's operating and financial performance;</li> <li>• The strength of equity markets in Europe and internationally;</li> <li>• Financial failure or default by any entity in which the Issuer may become involved in a contractual relationship; and</li> <li>• Industrial, political, and trade disputes in Europe and overseas.</li> </ul>		
<p><b>Pandemic risks</b></p> <p>Operationally and production-wise there are risks associated with pandemics. The effects of such pandemic risks are many-fold and can lead to different impairments for the Issuer, which in turn would have a negative impact on ROI for investors. The most recent COVID-19 pandemic, for example, has exposed numerous supply-chain items to the Issuer's management team to be prepared for so as to mitigate future impact on development and delivery schedules.</p>	low	Environmental risks
<p><b>Credit and default risk</b></p> <p>The Issuer bears full insolvency and default risk with respect to its contractual partners. A possible scenario would be that contractual partners of the Issuer do not meet their (financial) obligations, do so only partially, or not on time. Key accounts are insured to mitigate the operational impact of such events. Nevertheless, such events may affect the Issuer's business activities and may negatively impact ROI for investors.</p>	low	Finance Risks
<p><b>Reliance on key personnel</b></p> <p>Issuer's operational success will depend substantially on the continuing efforts of its senior executives. The loss of the service of one or more senior executives may have an adverse effect on the Issuer's operations. Furthermore, if the Issuer is unable to attract, train and retain key individuals and other highly skilled employees and consultants, its business may be adversely affected. To mitigate the impact of such potential events, the most important executives shall retain Key Man insurance to provide Issuer with the resources needed to offset such a loss and find a highly skilled replacement in an expeditious manner.</p>	low	Corporate Risks
<p><b>Issue costs</b></p> <p>The capital raised through the issue is also used to offset the costs associated with the offer in the Prospectus (issue costs) and is therefore not available in its entirety for investments. The Issuer may incur higher costs if it becomes necessary to intensify its sales activities. This would adversely affect the ratio of issue costs to issue proceeds. This also applies if the issue is closed prematurely and placed less than planned on the date of the Prospectus. As a result, there is a risk that the Issuer</p>	low	Finance Risks

will not be able to carry out its planned technical and business activities and meet its milestones.		
<p><b>Data loss, theft or corruption</b></p> <p>Issuer stores data with a variety of third-party service providers and cloud computing service providers. Hacking or exploitation of some unidentified vulnerability in its network could lead to loss, theft or corruption of data. Although Issuer has strategies and protections in place to try to minimise security breaches and to protect data, these strategies might not be successful. In the event of a security breach or loss, theft, or corruption of data, it is possible that the Issuer's revenues and profitability would be negatively affected.</p>	low	Technology Risks



### 3.3 Risks which are specific to the securities

	Risk Level	Risk category
<p><b>Risk of saleability, liquidity and realisation risk</b></p> <p>There is no certainty that a liquid market will develop for the AWEARE Global Tokens. As a result, AWEARE Global Tokens might not be able to be sold on a secondary market, creating liquidity risk for the investor.</p>	medium	Market Risks
<p><b>Volatility risk</b></p> <p>There are risks in connection with the volatility of the share price. If AWEARE Global Tokens were to be sold and they were caught in a sharp downward price fluctuation, the selling Tokenholder could suffer losses, some of which could be substantial, as a result of a rapid fluctuation in sale price.</p>	medium	Market Risks
<p><b>Investors Wallet and Private Key Risk</b></p> <p>The investor alone bears the risk of the selection of the wallet or the location of the private key. If an incompatible wallet is used or if the private key is lost, access to the AWEARE Global Tokens is normally impossible. The consequences, such as the total loss of the investment, must be borne solely by the investor.</p>	low	Technology Risks
<p><b>Loss of tokens</b></p> <p>Tokens may be lost or become inaccessible, in particular if the Tokenholder loses the respective private key to dispose of its AWEARE Global Tokens or due to malfunctioning of the e-wallet in which the AWEARE Global Tokens are stored. This could result in the loss of Tokens. It is the Tokenholders' sole responsibility to safely store and protect the private key that allows access to the e-wallet. Tokens may become inaccessible also in the case of death of a Tokenholder if he or she did not make arrangements for such cases. Neither the Issuer nor any other body or institution will be capable of restoring the access to a lost Tokenholder's wallet for the successors of the Tokenholder. The loss of private keys could furthermore reduce the availability of various functionalities of the STO and AWEARE Global Tokens. In particular, it may be impossible to issue AWEARE Global Tokens to subscribers or to make them transferable in which case they would remain paused indefinitely. Finally, there is a risk that an attacker may mint AWEARE Global Tokens for non-contributing addresses, alter confirmation status, or contribute uncontrolled amounts to the STO.</p>	low	Technology Risks
<p><b>Limited rights of Tokenholder</b></p> <p>AWEARE Global Tokens are non-voting participation certificates and do not entitle the Tokenholders to vote at, to convene the and to participate in the General Meeting of the Issuer. Furthermore, AWEARE Global Tokens do not grant the right to information, the right of inspection and the right to make an application. The Issuer's General Meeting may therefore adopt resolutions which may adversely affect Tokenholder rights. Tokenholders have no possibility to control the use of proceeds from the issuance of AWEARE Global Tokens. The transfer (such as transfer in the narrow sense, pledging, inheritance, etc.) of AWEARE Global Tokens requires the approval of the Issuer's Board of Directors.</p>	medium	Finance Risks

In any case, a transfer of AWEARE Global Tokens is not permitted if they would then be held by a person in a country in which AWEARE Global Tokens may not be offered. A transfer in the above sense is also deemed to occur if a Tokenholder moves its place of residence to a country in which AWEARE Global Tokens may not be offered. The statutory subscription right of the Tokenholders in the event of a capital increase under this offer is excluded.		
<b>Tokenholders' claims are subordinated</b> The rights of Tokenholders to claim and receive dividend payments from the Issuer is junior to the claims of all holders of unsubordinated obligations of the Issuer. In a liquidation of the Issuer, Tokenholders will be paid only if and after all senior obligations of the Issuer have been discharged.	medium	Finance Risks
<b>Risk of negative analyst assessment</b> The price of the AWEARE Global Tokens could be influenced by analysts' assessments and other opinions expressed in Internet forums, stock market letters, or other media. In the event of AWEARE Token sales, price losses could be realised for the selling Tokenholder.	low	Market Risks
<b>Risk of non-inclusion in a regulated market</b> The AWEARE Global Tokens will not be included in a regulated market. Important investor protection provisions of regulated markets therefore do not apply.	low	Market Risks
<b>Exchange rate</b> The issue currency is USD. In addition, AWEARE Global Tokens may also be acquired in other currencies or crypto currencies. Furthermore, dividend payments may also be conducted in other currencies or crypto currencies. When changing from crypto currencies into fiat money or other crypto currencies and vice versa, the investor/Tokenholder incurs transaction costs. Transaction costs burden the potential return of the investment.	low	Finance Risks

## 4. Terms and Conditions of the Securities

### 4.1 Information concerning the securities to be offered

#### 4.1.1 Description of the type and class of the securities

The **1,400,000** new participation certificates publicly offered by the Issuer are non-voting bearer participation certificates, each with a nominal value of **USD0.01** of the participation capital (the "**AWEARE Global Tokens**")., from a new issue of participation capital resolved by an extraordinary General Meeting on 18/07/2024.

The ISIN is LI1363014385.

Holders of AWEARE Global Tokens are called "**Participants**" or "**Tokenholders**".

#### **4.1.2 Legislation under which the securities have been created**

AWEARE Global Tokens have been created under the laws of the Principality of Liechtenstein.

#### **4.1.3 Currency of the securities issue**

Currency of the securities issue is the United States Dollar („USD“ or “\$”).

#### **4.1.4 Description of the rights attaching to the securities including restrictions**

##### **a) Right to vote**

AWEARE Global Tokens are non-voting participation certificates and do not entitle the Participant to vote at, to convene the, and to participate in the General Meeting of the Issuer. Furthermore, AWEARE Global Tokens do not grant the right to information, the right of inspection, and the right to make an application. However, a written request for information or inspection or for the initiation of an official audit may be submitted to the General Meeting.

##### **b) Dividend entitlement and share of liquidation proceeds**

AWEARE Global Tokens carry full dividend rights from the date of valid acquisition and entitle their holders to a share of the liquidation proceeds in proportion to their participation in the participation capital.

##### **c) Form and securitisation of AWEARE Global Tokens**

AWEARE Global Tokens will be issued as tokens. Tokens are value rights that are issued on a decentralised database (Blockchain) and transferred there. Blockchain refers to the Ethereum Blockchain.

##### **d) *Announcement of convening and resolutions of the General Meeting***

Participants must be notified of the convening of the General Meeting together with the items on the agenda and the motions. Every resolution of the General Meeting must be made available for inspection by the Participants at the registered office of the Issuer without delay. The Participants shall be informed of this in the notice.

##### **e) Exclusion of subscription rights and participation rights**

Until the target participation capital of USD50,000 is reached, the preferential rights according to Articles 304d, 304f and 304g PCL, in particular subscription rights and participation rights of the Participants, are excluded.

#### **4.1.5 Resolutions by virtue of which the securities have been or will be created and/or issued**

The new issue of AWEARE Global Tokens is based on the resolution of an extraordinary General Meeting on 18/07/2024.

#### **4.1.6 Expected issue date of the securities**

The expected issue date of AWEARE Global Tokens can not be stated. Once the total offering of AWEARE Global Tokens (after reaching the target participation capital) has ended and the Issuer has decided to finalise the Smart Contract, AWEARE Global Tokens will be delivered to the investor's crypto wallet.

If the minimum subscription volume of **USD3,000,000** is not reached within the offering period, the Issuer reserves the right to extend or terminate the offering. In the event of termination of the offering without reaching the minimum subscription volume, the funds already received will be refunded to the investors.

#### **What happens to the funds that have been received?**

The funds will be securely held until the issuance.

#### **How are these funds held?**

The received funds will be held in a multi signature wallet with 4 out of 6 signature rights with the trustee. This wallet is separate from the operational business account of the Issuer to ensure the security of the investors' funds.

#### **How are these funds remunerated (interest)?**

During the holding period, the investors' funds **will not bear interest**. There will be no interest or other compensation provided to investors.

#### **Does the investor have a right of return?**

Yes, under certain conditions. We refer to the [Right of withdrawal](#).

### **4.1.7 Restrictions on the free transferability of the securities**

The transfer (such as transfer in the narrow sense, pledging, inheritance) of AWEARE Global Tokens requires the approval of the Issuer's Board of Directors. Transferability is therefore limited to a certain extent. In any case, a transfer of AWEARE Global Tokens is not permitted if they would then be held by a person in a country in which AWEARE Global Tokens may not be offered. A transfer in the above sense is also deemed to occur if a Tokenholder moves its place of residence to a country in which AWEARE Global Tokens may not be offered.

### **4.1.8 Warning**

**The tax legislation of the Investor's state and of the Issuer's country of incorporation may have an impact on the income received from the securities.**

## **5. Details of the Offer/Admission to Trading**

### **5.1 Terms and conditions of the offer of securities to the public**

#### **5.1.1 Conditions to which the offer is subject**

##### **Countries in which the securities are offered**

The offering consists of public offers in the Austria, Belgium, Bulgaria, Croatia, Cyprus, Czech Republic, Denmark, Estonia, Finland, France, Germany, Greece, Hungary, Iceland, Ireland, Italy, Latvia, Liechtenstein, Lithuania, Luxembourg, Malta, Netherlands, Norway, Poland, Portugal,

Romania, Slovakia, Slovenia, Spain, Sweden, Switzerland as well as private placements in certain jurisdictions outside thereof.

#### **Countries in which the securities are not offered**

AWEARE Global Tokens of the Issuer are not and will not be registered under the provisions of the United States Securities Act of 1933, as amended, or with the securities regulatory authorities of any state of the United States of America, or in Australia, Japan or Canada. Accordingly, they will not be offered, sold or delivered directly or indirectly to the public, except pursuant to an exemption from the registration requirements. In particular, this Prospectus does not constitute or constitute an offer to sell or the solicitation of an offer to purchase AWEARE Global Tokens in the United States of America, Australia, Japan and Canada and may not be distributed therein. In addition, this Prospectus does not constitute or constitute an offer to sell or the solicitation of an offer to purchase AWEARE Global Tokens in Russia, Iran, and North Korea, Belarus, Syria, or any territories thereof, and may not be distributed therein.

**The Issuer** was founded in **2023** and is currently in the development phase. No revenues have been generated to date, as the company has been developing its innovative radar technologies to meet the needs of various civilian markets. **The product development and commercialization of these technologies will be funded with the proceeds from this offering.**

#### **Previous Investments:**

Prior to this offering, there have been investments made into the development of the radar technology through AWEARE Technologies Inc., the legal entity that provides the exclusive sales agreement to AWEARE Global AG. These investments have facilitated research and the initial stages of prototype development and secured the exclusive rights for AWEARE to market and sell the technology in the specified sectors.

#### **Planned Products and Services:**

**The Issuer** holds the exclusive rights to its radar technology in the following areas and plans to offer products and services in these markets:

1. **Automotive Industry Including Trucking:**
  - **Self-Driving Vehicles:** Development of radar sensors that enable the safe operation of autonomous vehicles in adverse weather conditions, enhancing safety and reliability.
  - **Adaptive Cruise Control (ACC):** Provision of radar systems that automatically maintain a safe distance between vehicles by adjusting speed.
  - **Collision Avoidance Systems:** Development of radar-assisted obstacle detection systems that issue warnings or initiate automatic braking.
  - **Blind Spot Detection:** Radar sensors to detect vehicles in blind spots, improving overall road safety.
2. **Rail Transportation:**
  - **Train Control Systems:** Use of radar in train control systems to maintain safe distances between trains and prevent collisions.
3. **Aviation:**
  - **Collision Avoidance:** Development of radar systems for detecting nearby aircraft, contributing to air traffic control and collision avoidance.
4. **Maritime and Navigation:**
  - **Navigation Radar:** Provision of essential radar systems for ships to detect other vessels, obstacles, and coastlines.

- **Collision Avoidance:** Use of radar to prevent collisions at sea, especially under low-visibility conditions.
- **Automated Docking:** Development of systems for automated docking and assistance for crewed and uncrewed vessels.
- 5. **Government and Security Applications:**
  - **Surveillance Radar:** Development of radar systems for border security, law enforcement, and monitoring activities in government and security operations.
  - **Target Tracking:** Radar for tracking and identifying moving objects to enhance physical security.
  - **Through-Wall Radar:** Applications for law enforcement to detect objects behind obstacles.
- 6. **Agriculture:**
  - **Precision Agriculture:** Use of radar for soil moisture measurement, crop monitoring, and harvested crop size estimation.
  - **Navigation and Safety:** Provision of autonomous systems for terrain sensing, obstacle avoidance, and animal/person detection to assist farmers.
- 7. **Infrastructure Monitoring:**
  - **Structural Health Monitoring of Buildings:** Use of ground-penetrating radar and through-wall radar to assess the condition of infrastructure such as bridges and buildings.
  - **Security Solutions for Warehouses, Retail, and Banking:** Development of systems for presence monitoring and intruder detection.
- 8. **Robotics:**
  - **Obstacle Avoidance:** Development of radar sensors for robots that enable navigation and obstacle avoidance in various environments.
- 9. **Consumer Electronics:**
  - **Smartphones and Wearables:** Integration of radar technology for gesture recognition, vital sign monitoring, and presence detection in consumer electronics.
- 10. **Mining Industry:**
  - **Collision Avoidance:** Use of radar to enhance safety by detecting obstacles and preventing collisions in mining operations.

These planned products and services showcase the versatility of radar technology across various industries and underscore **The Issuers** role in safety, navigation, monitoring, and law enforcement applications.

#### **Funding and Development Strategy:**

**The Issuer** plans to use the proceeds from this offering primarily to fund the research and development of these radar technologies. This includes investing in technology development, prototyping, testing, and bringing the products to market. The successful development and commercialization of these products are crucial for the company's future revenue generation and growth.

**Previous investments** made through AWEARE Technologies Inc., which provides the exclusive sales agreement to The Issuer, have laid the groundwork for the company's current development efforts. These investments have secured the exclusive rights to the radar technology for the specified sectors, enabling The Issuer to proceed with confidence in its market offerings.

## **Future Development and Market Introduction:**

The company plans to begin market introduction of its products and services in the coming fiscal years and aims to establish its technologies worldwide. The timeline for product launches is contingent upon the successful completion of research and development activities funded by this offering.

### **5.1.2 Issue volume**

The public offer comprises **1,400,000** AWEARE Global Tokens.

### **5.1.3 Offer period and application process**

#### **Bidding**

The subscription process for AWEARE Global Tokens will take place online at <https://kyc.awaretech.li/> (the “**Dashboard**”).

#### **Offer Period**

The period during which investors may submit their purchase offers for AWEARE Global Tokens is to begin on the date of approval of the Prospectus and to end one year later (the “**Offer Period**”). On the last day of the Offer Period, offers may be made until 12:00 noon Liechtenstein time.

### **5.1.4 Reduction of subscriptions**

The Issuer may reject subscription applications in whole or in part without giving reasons. In this case, the subscriber will be informed in writing via e-mail of the rejection of its subscription. Subscription amounts paid in by the subscriber and not or not fully taken into account will be refunded immediately. Interest will not be charged.

### **5.1.5 Minimum and/or maximum amount of application**

Minimum is 10 Token

Maximum is 20833 Token

### **5.1.6 Right of withdrawal**

Investors can withdraw from their contract declaration within 14 days without giving a reason by means of a clear statement. The period begins upon receipt of this instruction on a durable medium, but not before the conclusion of the contract and also not before fulfilment of the Issuer’s information obligations pursuant to Art. 5 Distance Marketing of Financial Services Act. In order to safeguard the withdrawal period, the timely dispatch of the withdrawal declaration is sufficient if the declaration is made on a durable medium (e.g. letter, email). The withdrawal is to be addressed to the Issuer.

In the event of an effective withdrawal, the services received by both parties shall be returned. Investors are obliged to pay compensation for the value of the service provided until the rescission if they have been informed of this legal consequence before submitting their contract declaration and have expressly agreed that the Issuer will begin to perform the consideration before the end of the rescission period. If there is an obligation to pay value compensation, this may result in the investor

nevertheless having to fulfil the contractual payment obligations for the period up to the rescission. The right of rescission expires prematurely if the contract is fully fulfilled by both parties at the express request of the investor before he has exercised his right of rescission. Obligations to refund payments must be fulfilled within 30 days. The period begins for the investor with the dispatch of his declaration of rescission, for the issuer with its receipt.

### **5.1.7 Delivery and settlement**

Each investor must complete the online subscription process at the Dashboard. AWEARE Global Tokens will be allocated off-chain as a record in the Issuer's database, which can be visible through the Dashboard, against payment of the Bid Price. AWEARE Global Tokens will be allocated on-chain in the Smart Contract at the latest within two months after the end of the Offer Period. Once the total offering of AWEARE Global Tokens (after reaching the target participation capital) has ended and the Issuer has decided to finalise the Smart Contract, AWEARE Global Tokens will be delivered to the investor's crypto wallet.

### **5.1.8 Results**

A full description of the results of the offer are made to be public through <https://kyc.awearetech.li/>.

## **5.2 Plan of distribution and allotment**

### **5.2.1 Categories of investors**

There is no reserved tranche with regards to subscription in any other countries. The Issuer targets with this offering following investor categories:

- Non-accredited investors (private individuals)
- Accredited investors (private individuals)
- Family Offices
- Venture Capital Firms
- Corporate Investors
- Institutional Investors
- Banks and Government Agencies

## **5.3 Process for notifying applicants of the amount allotted and an indication whether dealing may begin before notification is made**

Notifications will be accessible to each subscriber via <https://kyc.awearetech.li/>. AWEARE Global Tokens are subscribed at <https://kyc.awearetech.li/>. The subscription shall only become effective upon acceptance of the subscription by the Issuer. The acceptance of the subscription by the Issuer will be made through <https://kyc.awearetech.li/> under the tab contribute or through the KYC process itself. After the successful submission of the KYC application the subscriber will receive an email with the subscription details. Once the Issuer accepts the KYC application, the subscription becomes effective. Other information which is publicly available can be accessed via the website <https://awearetech.li/>.



## 5.4 Pricing

The bid price of one AWEARE Token is **USD12.00** (the “**Bid Price**”).

To encourage early investment, the following discounts are available:

For investments between 10,000 USDC and 49,999.99 USDC, investors will receive a discount of 10%, making the price per AWEARE Token **USD10.80**.

For investments of 50,000 USDC or more, investors will receive a discount of 15%, making the price per AWEARE Token **USD10.20**.

The availability of these discounts will end based on one of the following conditions, to be determined as most suitable for the instrument:

The discounts will end once a total of 5,000,000 USDC equivalent has been raised.

The discounts will end 3 months from the start of the offering.

## 5.5 Paying agent

There is no paying agent.

## 5.6 Admission to trading and dealing arrangements

AWEARE Global Tokens are not admitted to trading on a regulated market. The Issuer reserves the right to apply for admission to trading on a regulated market.

## 5.7 Total net proceeds and estimated issue costs

The total net proceeds of the total public offer may amount to approximately USD15,000,000 corresponding to the implementation of the fund raise. The expected total costs of the total public offer amount to approximately USD1,500,000 and will be charged from the proceeds.

The estimated net proceeds from the issue of the securities will be used primarily for research and development and IP protection. It might be necessary to shift up to 50% of an allocated budget to another position if required.

10% Cost of Raise  
11% General & Administrative  
41% Research & Development  
17% Legal (Global IP Protection)  
21% Bus Dev, Sales & Marketing

## 5.8 Applicable Law

The offer and the agreement for the purchase of AWEARE Global Tokens as well as all rights and obligations arising in connection with or from the offer and the agreement for the purchase of

AWEARE Global Tokens shall be governed exclusively by Liechtenstein law, excluding the conflict of law rules and referral provisions.

## 5.9 Place of Jurisdiction

The courts of the Principality of Liechtenstein shall have exclusive jurisdiction for all disputes arising out of or in connection with the offer or the agreement for the purchase of AWEARE Global Tokens, including those concerning the valid conclusion, legal validity, amendment or cancellation.

## 5.10 Severability

If at any time one or more of the provisions of the AWEARE Global Token Offer and the agreement for its purchase is or becomes unlawful, invalid, illegal or unenforceable in any respect, the validity, legality and enforceability of the remaining provisions shall not in any way be affected or impaired thereby.

## 6. Corporate Governance

The governing bodies of the Issuer are the General Meeting, the Board of Directors and the statutory Auditor. The competencies of these bodies are governed by the Liechtenstein Persons and Companies Law ("PCL"), the Articles of Association and the Organisational and Business Regulations.

### 6.1 Board of Directors

The Board of Directors currently consists of the following members:

**Dr. Daniel Hyman, Nationality:** United States, **Mail Address:** Long Beach, California, USA, Member of the Board of Directors

Dr. Hyman is the visionary behind the revolutionary DRONEKILLER® possessing formidable technical skills in radio-frequency electronics, hardware development, and scientific analysis. Demonstrated aptitude in developing, protecting, and navigating complex intellectual property holdings, the founder deftly combines patent generation and licensing strategies without suffering common tech industry's "not invented here" syndrome. As a goal-oriented leader, he effectively fosters collaborative environments within his companies and business partners, harmonising technical and business visions. With a track record for investor return, Dr. Hyman's strengths extend to commercialising technologies through customer development, showcasing project execution and product insertion. Dr. Hyman holds over 20 patents with over 100 papers and journal articles.

Dr. Daniel Hyman has not been convicted in relation to fraudulent offences, and he was not part of or involved with any bankruptcies, receiverships or liquidations.

Dr. Daniel Hyman has not been disqualified by a court from acting as a member of an administrative, management or supervisory body of any issuer or from acting in the management or conduct of the affairs of any issuer.

Dr. Daniel Hyman is one of the significant minority shareholders of the Issuer with shares held indirectly through a holding company (Global Innovation Partners Limited).

**Mahesh Reddy, Nationality:** United States, **Mail Address:** Irvine, California, USA, Member of the Board of Directors

A highly accomplished professional with a focus on assisting innovative companies across various sectors, currently serving as an advisor overseeing company operations to facilitate the successful introduction of new products to the market. Demonstrating leadership in executing complex development and production programs, Mr. Mahesh Reddy has a robust track record for delivering high-quality work on schedule. With comprehensive expertise spanning the entire product development life cycle, encompassing design, development, testing, integration, certification, production, and delivery, he has effectively managed a multi-billion dollar business with over 1,000 employees. Mr. Reddy has over 30 years of aerospace executive and technical leadership experience working for Rockwell Collins, BE Aerospace, and Boeing. Holder of four US Patents, this professional's key competencies include program management, engineering and technology leadership, turnaround expertise, managing transitions, strategy development and implementation, as well as effective management of suppliers, customers, and supply chains. Leadership, talent development, and collaborative teamwork contribute to Mr. Reddy's history of success. He is engaged in professional affiliations and served on the Board of Directors for Boeing California Employee Fitness, Inc., a non-profit organisation, and has been an Advisory Board Member and Past Director for the American Society of Engineers of Indian Origin.

Mahesh Reddy has not been convicted in relation to fraudulent offences, and he was not part of or involved with any bankruptcies, receiverships or liquidations.

Mahesh Reddy has not been disqualified by a court from acting as a member of an administrative, management or supervisory body of any issuer or from acting in the management or conduct of the affairs of any issuer.

Mahesh Reddy is one of the significant minority shareholders of the Issuer with shares held indirectly through a holding company (Global Innovation Partners Limited).

**Marcel Füssinger, Nationality:** Austria, **Mail address:** 160009 Singapore, Member of the Board of Directors

Born on August 15th, 1989, in Feldkirch, Austria, Marcel is a dynamic entrepreneur with a diverse professional background and a strong focus on tokenized assets since his tenure at SocialX Pte. Ltd. in 2017. With a keen eye for detail and a knack for problem-solving, Marcel has amassed extensive experience in various industries, showcasing his proficiency in web design, project management, and entrepreneurship. Marcel's journey began with hands-on experience as a spray painter at Liebherr, where he honed his skills in craftsmanship. Transitioning into the digital realm, Marcel excelled as a web designer and project manager at FotoDesk AG, spearheading website redesigns, SEO optimization, and online campaigns. His pivotal role at SocialX Pte. Ltd. marked his entry into the world of tokenized assets, where he led initiatives in blockchain technology and digital asset management. As the CEO of multiple ventures, Marcel demonstrated his leadership and strategic acumen, driving business growth and fostering innovation within the realm of tokenized assets. Currently serving as an Entrepreneur in Residence at [Equanimity AG](#) and Equanimity (Blockchain) Holdings Pte. Ltd., Marcel continues to push boundaries in blockchain project management and digital marketing, with a specific focus on [tokenized assets](#) and decentralised finance. With a robust skill set encompassing areas such as technical project management, branding, and sales, Marcel is poised to make a significant impact in the entrepreneurial landscape of tokenized assets. Beyond his

professional endeavours, Marcel is a dedicated advocate for personal growth and wellness, finding solace in silence and meditation, and fueling his passion for exploration through travel and road cycling.

Marcel Füssinger has not been convicted in relation to fraudulent offences, and he was not part of or involved with any bankruptcies, receiverships or liquidations.

Marcel Füssinger has not been disqualified by a court from acting as a member of an administrative, management or supervisory body of any issuer or from acting in the management or conduct of the affairs of any issuer.

**Revalier AG represented by Reinhold Wohlwend Nationality:** Liechtenstein, **Mailing address:** 9490, Vaduz, Liechtenstein

Mr Reinhold Wohlwend holds a Degree in Financial and Trust Services of the University of Liechtenstein (B.Sc.). He is a fully licensed Trustee in Liechtenstein since 2014. As the Owner and Managing Director of REVALIER he is carrying on the family business in the 3rd generation and is responsible for its international clients by offering comprehensive financial services.

Reinhold Wohlwend has not been convicted in relation to fraudulent offences, and he was not part of or involved with any bankruptcies, receiverships or liquidations.

Reinhold Wohlwend has not been disqualified by a court from acting as a member of an administrative, management or supervisory body of any issuer or from acting in the management or conduct of the affairs of any issuer.

## **6.2 Administrative, Management and Supervisory bodies' and Senior Management's conflicts of interests**

The current shareholders of AWEARE Global AG comprise Global Innovation Partners Limited as the majority shareholder, as well as Mahesh Reddy and Dr. Daniel Hyman, who hold options to purchase 21,875 ordinary shares each in addition to their minority holdings in Global Innovation Partners Limited.

Mahesh Reddy and Dr. Daniel Hyman are two of the three directors of AWEARE Global AG. Mahesh Reddy and Dr. Daniel Hyman are also both directors of Global Innovation Partners Limited, and therefore have significant supervisory roles in managing the affairs of AWEARE Global AG. They serve with the present approval and support of voting shareholders. Mahesh Reddy holds less than 10% of the securities of AWEARE Global AG and of Global Innovation Partners Limited and is therefore considered a minority shareholder in each organisation. Dr. Daniel Hyman holds less than 10% of the securities of AWEARE Global AG but holds more than 10% of the securities of Global Innovation Partners Limited and is considered a minority shareholder in each organisation.

The exclusive sales agreement with AWEARE Technologies, Inc. as a U.S. based supplier was negotiated in good faith with neutral party review. Mahesh Reddy and Dr. Daniel Hyman are two of the three directors of AWEARE Technologies, Inc. and are also minority shareholders. Dr. Hyman is a primary founder, financier, and officer of AWEARE Technologies, Inc. since 2017.

Equanimity AG receives a transaction fee of 3% of the total crypto currencies and fiat payments accrued. Marcel Füssinger, who is the third of three Directors of the Issuer, is also the Director and owner of Equanimity AG. Mr. Fussinger presently holds options to purchase 3,125 ordinary shares.

To the best of the Issuers knowledge, over the past five years there have been no public charges or sanctions by statutory or regulatory authorities (including particular professional associations) against the members of the Board of Directors or the management. None of these persons have ever been found unfit by a court to be a member of the administrative, management or supervisory body of an issuer or to work in the management or conduct of the business of an issuer.

### **6.3 The Auditor**

**The Auditor** examines whether the bookkeeping and the annual accounts comply with the law. The Auditor prepares an audit report.

**Lucas Tihanyi**, Industriering 14, 9491 Ruggell, Liechtenstein, Principality of Liechtenstein, has audited the annual financial statements as at 31 December 2023 and the interim financial statements as at 15 July 2023. .

Lucas Tihanyi is member of the Liechtenstein Association of Auditors and EXPERTsuisse.

Lucas Tihanyi has not been convicted in relation to fraudulent offences, and he was not part of or involved with any bankruptcies, receiverships or liquidations.

Lucas Tihanyi has not been disqualified by a court from acting as a member of an administrative, management or supervisory body of any issuer or from acting in the management or conduct of the affairs of any issuer.

### **6.4 Remuneration and benefits**

The Issuer is an owner-managed company. For this reason, no compensation in the form of wages will be paid to the Board of Directors until the outlook is stable.

The Issuer has not created any reserves or provisions for pension or similar obligations.

### **6.5 Board Practices**

The service contracts between members of the administrative, management, or supervisory bodies and the Issuer do not provide for any benefits upon termination of the service relationship. The Issuer maintains neither an audit committee nor a remuneration committee. The Issuer is a start-up and complies with all rules of professional conduct. There are no future changes in the composition of the governing body as per the annual general meeting.

### **6.6 Employees**

At the end of the 2023 financial year, the Issuer had 0 employees.

## 6.7 Shareholdings and stock options

<b>AWEARE Global AG Capitalization Table</b>	<b>Fully Diluted Shares</b>	<b>% Total</b>
Global Innovation Partners Limited (BVI Co. 2141228)	4,250,000	85%
Employee Option Pool	750,000	15%
Total allocated shares	5,000,000	100%

## 7. Financial Information

### 7.1 Historical financial information

The Issuer was founded on 30 November 2023 by entry in the commercial register of the Principality of Liechtenstein. According to the declaration of the Board of Directors dated 25 October 2023, the issuer is not subject to an ordinary audit and is not subject to an audit review. However, the annual financial statements as at 31 December 2023 and the interim financial statements as at 15 July 2023 were audited by the auditor.

The following key financial information has been prepared in accordance with the provisions of the Liechtenstein Persons and Companies Law ("PCL"), in particular Art. 1024 et seq.

#### Income statement

	<b>31/12/2023</b>	<b>15/07/2024</b>
<b>Total revenue</b>	<b>USD 0</b>	<b>USD 0</b>
<b>Operating profit/loss</b>	<b>USD -2'473.03</b>	<b>USD -30'150.54</b>
<b>Net profit/loss</b>	<b>USD -2'473.03</b>	<b>USD -30'150.54</b>

#### Balance sheet

	<b>31/12/2023</b>	<b>15/07/2024</b>
<b>Total assets</b>	<b>USD 50'184.35</b>	<b>USD 72'888.69</b>
<b>Total equity</b>	<b>USD 47'526.97</b>	<b>USD 19'849.46</b>
<b>Net financial debt (long term debt plus short term debt minus cash)</b>	<b>USD 0</b>	<b>USD 0</b>

#### Cash flow statement

	<b>31/12/2023</b>	<b>15/07/2024</b>
<b>Relevant net Cash flows from operating activities</b>	<b>USD 0</b>	<b>USD 0</b>

Relevant net Cash flows from investing activities	USD 0	USD 0
Relevant net Cash flows from financing activities	USD 0	USD 0

The latest detailed financial statements of the Issuer could be accessed in the links provided in the section '11. Documents Available'.

According to the interim balance sheet as of **15 July 2024 (all amounts in USD)**, the company reported **total equity of USD 20,197.10**, compared to the original share capital of **USD 50,000**. **This indicates that the Issuer was over-indebted as of the balance sheet date and is still over-indebted at the time of approval of this Prospectus.**

The Issuer is currently not carrying out any direct activities until the capital for product development is available from the present capital raising according to this Prospectus, which is why the Issuer's cash flow statement shows a zero.

## 7.2 Significant change in the issuer's financial position

There have been no significant changes in the Issuer's financial position or trading position since the reporting date of the balance sheet as at 15/07/2024.

## 7.3 Dividend policy

No dividends have been paid to date. The Issuer does not make any profit forecasts or estimates and therefore a description of the dividend policy is not made. Dividends, if any, will be paid in USD. The Issuer reserves the right to pay dividends also in another currency or cryptocurrency. Any resolution to pay dividends will be taken in accordance with applicable law and will depend, inter alia, on the Issuer's results of operations, financial position, contractual restrictions and capital requirements. In any case, 5% of the net profit will be allocated to the statutory reserves until this has reached the amount of 10% of the paid-in share capital.

## 8. Shareholder and security holder information

### 8.1 Major ordinary shareholders

Shareholder	Ordinary Shares	Percentage	Voting Interest
Global Innovation Partners Limited (BVI Co. 2141228) with majority shareholders Dr. Daniel Hyman, Mahesh Reddy, Dr. Reginald Tang, and Mark Hyman	4,250,000	85%	4,250,000

Employee Option Pool	750,000	15%	750,000
Total allocated shares	5,000,000	100%	5,000,00

The shareholders do not have different voting interests.

## 8.2 Legal and arbitration proceeding

There are no legal or arbitration proceedings against the Issuer.

## 8.3 Share capital

The current share capital of the Issuer amounts to **USD 50,000.00**. It is divided into 5,000,000 ordinary name shares with a nominal value of USD 0.01 each and fully paid up.

## 8.4 Information on the borrowing requirements and funding structure

The Issuer currently has no need for borrowing or external financing. To date, the Issuer has been financed through equity. The present public offer also constitutes equity financing.

## 8.5 Information regarding any restrictions on the use of capital resources that have materially affected, or could materially affect, directly or indirectly, the issuer's operations

There are currently no restrictions on recourse to capital resources that have directly or indirectly materially impaired or could materially impair the Issuer's business.

## 9. ESSENTIAL INFORMATION

### 9.1 Working capital statement

From the Issuer's point of view, the working capital fully covers the current requirements.

### 9.2 Capitalisation and indebtedness

As at 15/07/2024, the Issuer's capitalisation (wallet balances) was USDC 72'888.69.



### **9.3 Interest of natural and legal persons involved in the issue**

The current shareholders of AWEARE Technologies Inc. and Global Innovation Partners Limited include Mahesh Reddy and Dr. Daniel Hyman. Mahesh Reddy and Dr. Daniel Hyman are also directors and minority shareholders of the Issuer.

Equanimity AG receives a transaction fee of 3% of the total crypto currencies and fiat payments accrued. Marcel Füssinger, who is one of the Directors of the Issuer, is also the Director and owner of Equanimity AG.

## **10. Taxation**

### **10.1 Taxation of the Issuer**

With its taxable income in Liechtenstein, the Issuer is subject to income tax at the rate of 12.5% for taxable net income.

### **10.2 Taxation of Participants**

Tokenholders are subject to taxation in particular in connection with the holding of shares (taxation of dividends), the sale of shares and subscription rights (taxation of capital gains) as well as the free transfer of shares and subscription rights (inheritance and gift tax).

#### **10.2.1 Participants resident in Liechtenstein**

For investors (natural persons) with tax residence in Liechtenstein, dividends as well as capital gains from shares are tax-free, provided that the securities are subject to wealth tax.

Dividends and capital gains from shares are generally treated as tax-free income in respect of legal entities tax residence in Liechtenstein.

#### **10.2.2 Participants resident abroad**

Foreign Tokenholders are required and obliged to declare and pay the taxes applicable to the tax law of their tax residence.

### **10.3 Responsibility for withholding taxes at source**

In principle, the Issuer does not have to withhold and pay any withholding tax when paying dividends.

## **11. Documents Available**

For the term of the registration document the following documents can be inspected on [Google Drive](#):

- (a) [Articles of Association of the Issuer dated 18.07.24 \(DE & EN\)](#)

- (b) [2024 - Commercial Register Excerpt of the Issuer 07.08.2024](#)
- (c) [Audit Report Aweare Global AG 2023](#)
- (d) [Audit Report Aweare Global AG 15.07.24](#)
- (e) [Organisational Chart AWEARE Global AG](#)
- (f) [Redacted - Exclusive Sales Agreement with AWEARE Technologies Inc.](#)
- (g) [Commercial Register Extract AWEARE Technologies Inc.](#)
- (h) [Commercial Register BVI Global Innovation Partners Limited](#)
- (i) [BDO Liechtenstein Valuation letter](#)
- (j) [Worcester Polytechnic institute Witness Letter](#)
- (k) [MRD LOI](#)

## 12. Material Contracts

Exclusive Sales Agreement with AWEARE Technologies, Inc.

On 05.09.2024, AWEARE Global AG entered into an exclusive sales agreement with AWEARE Technologies, Inc., a technology company based in the United States.

Parties to the Agreement:

- AWEARE Global AG (the Issuer), a company incorporated under the laws of Liechtenstein.
- AWEARE Technologies, Inc., a company incorporated under the laws of California in the United States that specialises in the development of radar technologies.

Subject of the Agreement:

- AWEARE Global AG is granted the exclusive right to market, sell, and distribute certain radar technologies developed by AWEARE Technologies, Inc. in specified sectors.
- The agreement specifically covers the following non-ITAR restricted sectors:
  - Automotive
  - Trucking
  - Light rail
  - High speed rail
  - Aviation
  - Maritime
  - Government
  - Infrastructure
  - Construction
  - Robotics
  - Consumer electronics
  - Security
  - Law enforcement
  - Agriculture
  - Mining industry

Term of the Agreement:

- The agreement became effective on 05.09.2024 and has a term of ten years with an option for renewal upon mutual agreement.

Key Terms and Obligations:

- AWEARE Technologies, Inc. commits to supplying products that meet requirements as specified in the Agreement, and to providing necessary support and updates.
- AWEARE Global AG is responsible for marketing, sales, distribution, and customer support within the agreed sectors.
- Financial terms include product pricing and payment terms typical for the industry.

Termination Provisions:

- The agreement can be terminated as a result of material default due to lack of required payments, subjection to levy or seizure by creditor or government, failure to deliver products in the time and manner so designated, or buyer's violation of government export control regulations.

Significance to the Issuer:

- This exclusive sales agreement is crucial to the business model of AWEARE Global AG as it provides the company with access to critical hardware to help pursue its strategic objectives.
- Without this agreement, AWEARE Global AG will lose some competitive advantage in the autonomous vehicle industry.
- Termination or unfavorable modification of this agreement could have a material adverse effect on the business, financial condition, and results of operations of the Issuer.

### 13. Signature Page

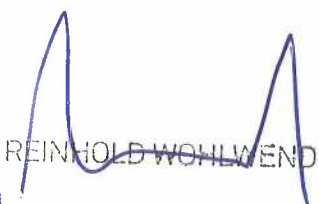
  
REINHOLD WOHLWEND  
05.12.2024  
Date, Signature